

# MOUNTING AND OPERATING INSTRUCTIONS



**EB 8384-2 EN (1300-1611)**

**Translation of original instructions**



## **Type 3730-2 Electropneumatic Positioner**

Firmware version 1.61

**CE** Ex  
certified

Edition January 2018



## Note on these mounting and operating instructions

These mounting and operating instructions assist you in mounting and operating the device safely. The instructions are binding for handling SAMSON devices.

- For the safe and proper use of these instructions, read them carefully and keep them for later reference.
- If you have any questions about these instructions, contact SAMSON's After-sales Service Department ([aftersaleservice@samson.de](mailto:aftersaleservice@samson.de)).



The mounting and operating instructions for the devices are included in the scope of delivery. The latest documentation is available on our website at [www.samson.de](http://www.samson.de) > **Service & Support** > **Downloads** > **Documentation**.

## Definition of signal words

### **DANGER**

*Hazardous situations which, if not avoided, will result in death or serious injury*

### **WARNING**

*Hazardous situations which, if not avoided, could result in death or serious injury*

### **NOTICE**

*Property damage message or malfunction*

### **Note**

*Additional information*

### **Tip**

*Recommended action*

<b>1</b>	<b>Safety instructions and measures</b> .....	<b>7</b>
1.1	Notes on possible severe personal injury .....	11
1.2	Notes on possible personal injury .....	11
1.3	Notes on possible property damage .....	12
<b>2</b>	<b>Markings on the device</b> .....	<b>13</b>
2.1	Nameplate .....	13
2.2	Article code .....	14
2.3	Firmware versions .....	16
<b>3</b>	<b>Design and principle of operation</b> .....	<b>19</b>
3.1	Mounting versions .....	20
3.2	Additional equipment .....	20
3.3	Configuration using the TROVIS-VIEW software .....	21
3.4	Device overview and operating controls .....	22
3.5	Accessories .....	23
3.5.1	Travel tables .....	28
3.6	Technical data .....	29
3.7	Dimensions in mm .....	35
3.8	Fixing levels according to VDI/VDE 3845 (September 2010) .....	39
<b>4</b>	<b>Measures for preparation</b> .....	<b>41</b>
4.1	Unpacking .....	41
4.2	Transporting .....	41
4.3	Storage .....	41
<b>5</b>	<b>Mounting and start-up</b> .....	<b>43</b>
5.1	Mounting position .....	43
5.2	Lever and pin position .....	43
5.3	Direct attachment .....	46
5.3.1	Type 3277-5 Actuator .....	46
5.3.2	Type 3277 Actuator .....	48
5.4	Attachment according to IEC 60534-6 .....	50
5.5	Attachment according to VDI/VDE 3847-1 .....	52
5.6	Attachment according to VDI/VDE 3847-2 .....	56

## Contents

5.6.1	Version for single-acting actuator .....	58
5.6.2	Version for double-acting actuator.....	60
5.7	Attachment to Type 3510 Micro-flow Valve .....	64
5.8	Attachment to rotary actuators .....	64
5.8.1	Heavy-duty version .....	66
5.9	Reversing amplifier for double-acting actuators .....	70
5.9.1	Reversing amplifier (1079-1118 or 1079-1119) .....	70
5.10	Attachment of external position sensor.....	72
5.10.1	Mounting the position sensor with direct attachment.....	73
5.10.2	Mounting the position sensor with attachment according to IEC 60534-6 .....	75
5.10.3	Mounting the position sensor to Type 3510 Micro-flow Valve.....	76
5.10.4	Mounting on rotary actuators.....	77
5.11	Mounting the leakage sensor .....	78
5.12	Retrofitting an inductive limit switch .....	79
5.13	Attaching positioners with stainless steel housings.....	80
5.14	Air purging function for single-acting actuators .....	80
5.15	Pneumatic connections.....	83
5.15.1	Connecting the supply air .....	83
5.15.2	Signal pressure gauges .....	84
5.15.3	Supply pressure .....	84
5.15.4	Signal pressure (output) .....	85
5.16	Electrical connections .....	85
5.16.1	Connecting the electrical power .....	88
5.16.2	Switching amplifier according to EN 60947-5-6 .....	89
<b>6</b>	<b>Operation .....</b>	<b>91</b>
6.1	Serial interface .....	93
<b>7</b>	<b>Operating the positioner.....</b>	<b>95</b>
7.1	Determining the fail-safe position .....	96
7.2	Adjusting the volume restriction Q .....	96
7.3	Adapting the display direction .....	97
7.4	Limiting the signal pressure .....	98
7.5	Checking the operating range of the positioner .....	98
7.6	Initialize the positioner .....	100



7.6.1	MAX – Initialization based on maximum range .....	102
7.6.2	NOM – Initialization based on nominal range .....	103
7.6.3	MAN – Initialization based on a manually selected range .....	105
7.6.4	SUb – Substitute calibration .....	106
7.7	Zero calibration .....	111
7.8	Adjusting inductive limit switch .....	112
7.9	Reset to default settings .....	114
7.10	Enabling and selecting parameters .....	115
7.11	Operating modes .....	116
7.11.1	Automatic and manual modes .....	116
7.11.2	Fail-safe position (SAFE) .....	117
<b>8</b>	<b>Servicing.....</b>	<b>119</b>
8.1	Firmware update.....	119
8.2	Preparation for return shipment .....	120
<b>9</b>	<b>Malfunctions .....</b>	<b>121</b>
9.1	Confirming error messages .....	122
9.2	Emergency action .....	122
<b>10</b>	<b>Decommissioning and removal .....</b>	<b>123</b>
10.1	Decommissioning .....	123
10.2	Removing the positioner .....	123
10.3	Disposal .....	123
<b>11</b>	<b>Appendix.....</b>	<b>125</b>
11.1	After-sales service .....	125
11.2	Certificates .....	125
11.3	Code list.....	126
11.4	Error codes.....	135
11.5	Selecting the characteristic.....	143

---

**i Note**

The functions of the **EXPERTplus** Valve Diagnostics are described in the Operating Instructions ► **EB 8389**. EB 8389 is included on the enclosed CD-ROM and is available on our website.

---

# 1 Safety instructions and measures

## Intended use

SAMSON's Type 3730-2 Positioner is mounted on pneumatic control valves and is used to assign the valve position to the control signal. The device is designed to operate under exactly defined conditions (e.g. operating pressure, temperature). Therefore, operators must ensure that the positioner is only used in applications where the operating conditions correspond to the technical data. In case operators intend to use the positioner in other applications or conditions than specified, contact SAMSON.

SAMSON does not assume any liability for damage resulting from the failure to use the device for its intended purpose or for damage caused by external forces or any other external factors.

➔ Refer to the technical data for limits and fields of application as well as possible uses.

## Reasonably foreseeable misuse

The Type 3730-2 Positioner is **not** suitable for the following applications:

- Use outside the limits defined during sizing and by the technical data

Furthermore, the following activities do not comply with the intended use:

- Use of non-original spare parts
- Performing maintenance activities not specified by SAMSON

## Qualifications of operating personnel

The positioner is to be mounted, started up or operated only by trained and experienced personnel familiar with the product. According to these mounting and operating instructions, trained personnel refers to individuals who are able to judge the work they are assigned to and recognize possible hazards due to their specialized training, their knowledge and experience as well as their knowledge of the applicable standards.

Explosion-protected versions of this device are to be operated only by personnel who has undergone special training or instructions or who is authorized to work on explosion-protected devices in hazardous areas.

## Safety instructions and measures

### Personal protective equipment

No personal protective equipment is required for the direct handling of the positioner. Work on the control valve may be necessary when mounting or removing the device.

- Observe the requirements for personal protective equipment specified in the valve documentation.
- Check with the plant operator for details on further protective equipment.

### Revisions and other modifications

Revisions, conversions or other modifications of the product are not authorized by SAMSON. They are performed at the user's own risk and may lead to safety hazards, for example. Furthermore, the product may no longer meet the requirements for its intended use.

### Safety features

Upon failure of the air supply or electric signal, the positioner vents the actuator, causing the valve to move to the fail-safe position determined by the actuator.

### Warning against residual hazards

The positioner has direct influence on the control valve. Any hazards that could be caused in the valve by the process medium, the signal pressure or by moving parts are to be prevented by taking appropriate precautions. They must observe all hazard statements, warning and caution notes in these mounting and operating instructions, especially for installation, start-up and service work.

If inadmissible motions or forces are produced in the pneumatic actuator as a result of the supply pressure level, it must be restricted using a suitable supply pressure reducing station.

### Explosion protection

#### – Explosive dust atmospheres of zone 21 or zone 22

The following applies to type of protection Ex i in combustible dust atmospheres:

If intrinsic safety is impaired by the influence of dust, an enclosure complying with Clause 6.1.3 of EN 60079-11 with at least in degree of protection IP 5X must be used.

The requirements according to Clause 6.1.3 apply to the cable glands accordingly. The degree of ingress protection is verified by a test according to IEC 60529 and EN 60079-0 (e.g. performed by VDE).

For use in the presence of combustible dust in compliance with type of protection Ex tb IIC (protection by enclosure), observe Clause 5.6.3 of EN 60079-14.

### – Servicing explosion-protected devices

If a part of the device on which the explosion protection is based needs to be serviced, the device must not be put back into operation until a qualified inspector has assessed it according to explosion protection requirements, has issued an inspection certificate, or given the device a mark of conformity. Inspection by a qualified inspector is not required if the manufacturer performed a routine test on the device before putting it back into operation. Document the passing of the routine test by attaching a mark of conformity to the device.

Replace explosion-protected components only with original, routine-tested components by the manufacturer.

Devices that have already been used outside hazardous areas and are intended for future use inside hazardous areas must comply with the safety requirements placed on serviced devices. Before being operated inside hazardous areas, test the devices according to the specifications for servicing explosion-protected devices.

EN 60079-17 applies to servicing explosion-protected devices.

### – Maintenance, calibration and work on equipment

To ensure that components relevant to explosion protection are not damaged, observe the maximum permissible values specified in the certificates for intrinsically safe circuits.

### Responsibilities of the operator

The operator is responsible for proper operation and compliance with the safety regulations. Operators are obliged to provide these mounting and operating instructions to the operating personnel and to instruct them in proper operation. Furthermore, the operator must ensure that operating personnel or third persons are not exposed to any danger.

### Responsibilities of operating personnel

Operating personnel must read and understand these mounting and operating instructions as well as the specified hazard statements, warning and caution notes. Furthermore, the operating personnel must be familiar with the applicable health, safety and accident prevention regulations and comply with them.

### Referenced standards and regulations

The device with a CE marking fulfills the requirements of the Directives 2014/30/EU and 2011/65/EU as well as 2014/34/EU depending on the version. The declarations of conformity are included at the end of these instructions.

### Referenced documentation

The following documents apply in addition to these mounting and operating instructions:

- Operating instructions for valve diagnostics: ► EB 8389
- The mounting and operating instructions of the components on which the positioner is mounted (valve, actuator, valve accessories, etc.).

## 1.1 Notes on possible severe personal injury

### DANGER

#### **Risk of fatal injury due to the formation of an explosive atmosphere.**

Incorrect installation, operation or maintenance of the positioner in potentially explosive atmospheres may lead to ignition of the atmosphere and cause death.

- ➔ The following regulations apply to installation in hazardous areas: EN 60079-14 (VDE 0165, Part 1).
- ➔ Installation, operation or maintenance of the positioner must only be performed by personnel who has undergone special training or instructions or who is authorized to work on explosion-protected devices in hazardous areas.

## 1.2 Notes on possible personal injury

### WARNING

#### **Risk of personal injury due to moving parts on the valve.**

During initialization of the positioner and during operation, the actuator stem moves through its entire travel range. Injury to hands or fingers is possible if they are inserted into the valve.

- ➔ During initialization, do not insert hands or fingers into the valve yoke and do not touch any moving valve parts.

## 1.3 Notes on possible property damage

### ! NOTICE

#### **Risk of damage to the positioner due to incorrect mounting position.**

- Do not mount the positioner with the back of the device facing upward.
- Do not seal or restrict the vent opening when the device is installed on site.

#### **Risk of malfunction due to incorrect sequence during start-up.**

The positioner can only work properly if the mounting and start-up are performed in the prescribed sequence.

- Perform mounting and start-up as described in section 5.

#### **An incorrect electric signal will damage the positioner.**

A current source must be used to provide the electrical power for the positioner.

- Only use a current source and never a voltage source.

#### **Incorrect assignment of the terminals will damage the positioner and will lead to malfunction.**

For the positioner to function properly, the prescribed terminal assignment must be observed.

- Connect the electrical wiring to the positioner according to the prescribed terminal assignment.

#### **Malfunction due to initialization not yet completed.**

The initialization causes the positioner to be adapted to the mounting situation. After initialization is completed, the positioner is ready to use.

- Initialize the positioner on the first start-up.
- Re-initialize positioner after changing the mounting position.

#### **Risk of positioner damage due to incorrect grounding of the electric welding equipment.**

- Do not ground electric welding equipment near to the positioner.



## 2 Markings on the device

### 2.1 Nameplate

#### Explosion-protected version

<b>SAMSON 3730 - 2</b>		9
Positioner		
Supply	1	
	2	
Input	3	
	4	
<p>* See technical data and explosion-protection certificate for permissible ambient temperature and maximum values for connection to certified intrinsically safe circuits.</p> <p>** IP 66 with conductive dust</p>		
<b>Diagnostics EXPERTplus</b>		
Firmware	5	
Model 3730 - 2	6	
Var.-ID	7	Serial no. 8
SAMSON AG D-60314 Frankfurt Made in Germany		

- 1 Supply pressure
- 2 Type of protection for explosion-protected devices
- 3 Input signal
- 4 Features:  Yes/ No
  - Fault indicator
  - Position indicator
  - Binary input
  - Leakage detection
  - Limit switch, inductive
  - Limit switches, software
  - Solenoid valve

#### Version without explosion protection

<b>SAMSON 3730 - 2</b>		9
Positioner		
Supply	1	
Input	3	
	4	
<p>! See technical data for ambient temperature</p>		
<b>Diagnostics EXPERTplus</b>		
Firmware	5	
Model 3730 - 2	6	
Var.-ID	7	Serial no. 8
SAMSON AG D-60314 Frankfurt Made in Germany		

- 5 Firmware version (see section 2.3)
- 6 Model no.
- 7 Configuration ID
- 8 Serial number
- 9 Compliance

## Markings on the device

### 2.2 Article code

Positioner	Type 3730-2	x	x	x	x	x	x	x	0	x	0	0	x	0	x	x
With display and autotune, 4 to 20 mA set point, two software limit switches, one fault alarm contact																
Explosion protection																
Without	0															
ATEX II 2G Ex ia IIC T6 Gb, II 2D Ex ia IIIC T80°C Db	1															
CSA Ex ia IIC T6, Class I Zone 0; Class I, II, Groups A, B, C, D, E, F, G; Class I, Zone 2; Class I, II, Div. 2, Groups A, B, C, D, E, F, G; Class III; Type 4 Enclosure	3															
FM Class I, Zone 0 AEx ia IIC; Class I,II,III, Div.1, Groups A, B, C, D, E, F, G; Class I, Div.2, Groups A, B, C, D; Class II,III, Div.2, Groups F, G																
ATEX II 2D Ex tb IIIC T80°C Db	5															
JIS Ex ia IIC T6	7															
ATEX II 3G Ex nA IIC T6 Dc, II 3D Ex tc IIIC T80°C Dc	8															
Option (additional equipment)																
Inductive limit switch																
Without	0															
SJ2-SN (NC contact)	1															
Solenoid valve																
Without	0															
With, 24 V DC	4															
Analog position transmitter																
Without				0												
With				1	0	0	0									
External position sensor																
Without						0										
With		0			1					0						
Prepared connection		0			2											
Leakage sensor																
Without											0					
With					0	0	1	0								
Binary input																
Without															0	

Positioner	Type 3730-2	x	x	x	x	x	x	x	x	0	x	0	0	x	0	x	x
With display and autotune, 4 to 20 mA set point, two software limit switches, one fault alarm contact																	
With		0	0	0	2												
Diagnostics																	
EXPERTplus					4												
Housing material																	
Aluminum (standard)									0								
Stainless steel 1.4408		0							1								
Special application																	
Without													0				
Device completely free of paint-impairing substances																	1
Exhaust air with ¼ NPT connection, back of housing sealed																	2
Attachment according to VDI/VDE 3847 including interface																	6
Attachment according to VDI/VDE 3847 prepared for interface																	7
Special version																	
Without																	0 0
IECEx Ex ia IIC T6...T4 Gb; Ex ia IIIC T80°C Db	1																1 2
Ex tb IIIC T80°C Db	5																3 4
Ex nA IIC T6...T4 Gc; Ex tc IIIC T80°C Dc	8																1 3
EAC Ex 1 Ex ia IIC T6/T5/T4 Gb X; Ex tb III T 80°C Db X	1																1 4
2Ex nA IIC T6/T5/T4 Gc X; 2Ex ic IIC T6/T5/T4 Gc X; Ex tc IIIC T 80°C Dc X	8																2 0

### 2.3 Firmware versions

Firmware revisions	
Old	New
1.01	<b>1.10</b>
	The positioner can be configured and operated over the TROVIS-VIEW software after connecting it to the computer over the serial interface and the serial interface adapter.
	The following status messages have been added: <ul style="list-style-type: none"> <li>• Code 76 – No emergency mode</li> <li>• Code 77 – Program load error</li> </ul> Reading indicates the number of zero calibrations performed since the last initialization.
	For initialization of "AIR TO CLOSE" actuators, the direction of action (Code 7) is automatically set to increasing/decreasing.
	Code 3, the activation period of the enabled configuration function has been extended to 120 s.
1.10	<b>1.20</b>
	Electronics changed, no new functions added.
1.20	<b>1.30</b>
	New EXPERTplus diagnostics functions (Code 48) added. Positioner in EXPERTplus version with extended diagnostics features.
	An initialization procedure in progress can be canceled by pressing the rotary pushbutton.
	The position transmitter (Code 37) and solenoid valve (Code 45) options are automatically detected.
1.30	<b>1.40</b>
	All EXPERTplus functions can be used in this firmware version and higher.
	The fault alarm contact is triggered by the condensed state of the positioner. It is always active with 'Maintenance alarm' condensed state. <ul style="list-style-type: none"> <li>• When Code 32 = YES: also active with 'Function check' condensed state</li> <li>• When Code 33 = YES: also active with 'Maintenance required/Maintenance demanded' condensed state</li> </ul>
	The 'Function check' condensed state is additionally set for Test A1, A2, fault alarm output and position transmitter.
	The min./max. values of the temperature monitoring can be reset.
1.40	<b>1.41</b>
	Internal revisions

Firmware revisions	
Old	New
1.41	1.42
	Internal revisions
1.42	1.51
	All EXPERTplus diagnostic functions are available without having to activate them in the positioner (▶ EB 8389 on EXPERTplus Valve Diagnostics).
	Optional binary input with following actions: <ul style="list-style-type: none"> <li>• Transmit switching state</li> <li>• Activate local write protection</li> <li>• Switch between automatic and manual modes</li> <li>• Various diagnostic functions ▶ EB 8389 (EXPERTplus valve diagnostics)</li> </ul>
	The pressure limit (Code 16) is no longer automatically set during initialization.
1.51	1.54
	Internal revisions
1.54	1.55
	Code 4: the setting for 300 mm has been added to the pin position
1.55	1.56
	Internal revisions
1.56	1.61
	<ul style="list-style-type: none"> <li>• Additional function: the step response test can be started by a rising edge at the binary input (▶ EB 8389 on EXPERTplus valve diagnostics).</li> </ul>



### 3 Design and principle of operation

→ Refer to Fig. 1

The electropneumatic positioner is mounted on pneumatic control valves and is used to assign the valve position (controlled variable  $x$ ) to the control signal (set point  $w$ ). The electric signal from a controlling system is compared to the travel or the rotational angle of the control valve and a signal pressure

(output variable  $y$ ) is produced for the actuator.

The positioner consists of a travel sensor system (2) proportional to resistance, an analog i/p converter with a downstream air capacity booster (7) and the electronics with microcontroller (5).

The positioner is fitted with three binary contacts as standard: A fault alarm output indicates a fault to the control room and two configurable software limit switches are used to indicate the end positions of the valve.

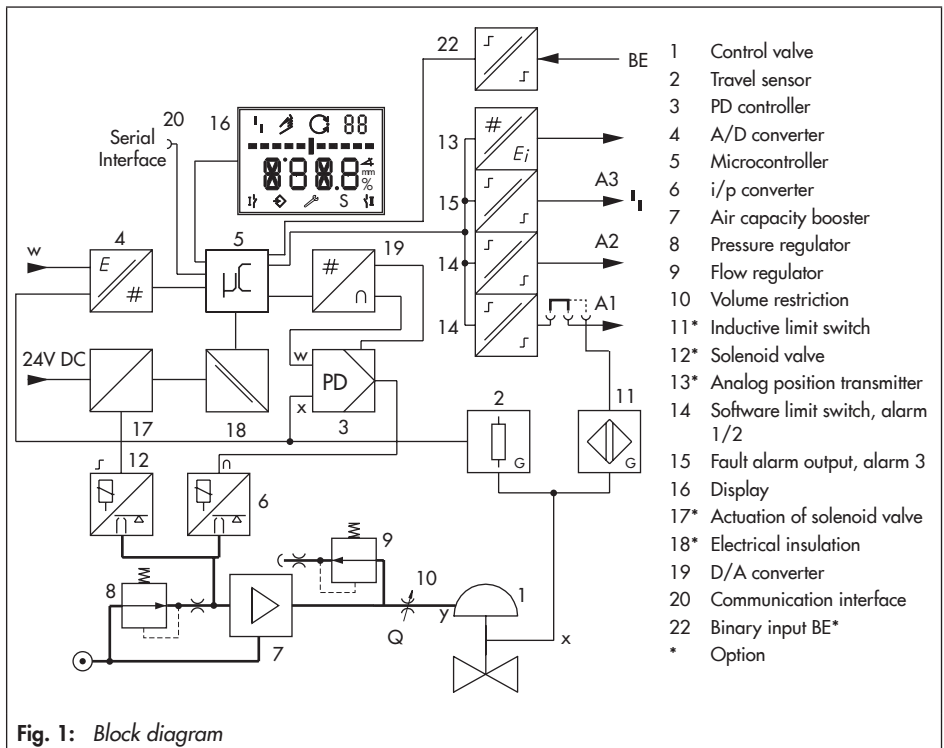


Fig. 1: Block diagram

## Design and principle of operation

The valve position is transmitted as either an angle of rotation or travel to the pick-up lever and to the travel sensor (2) and supplied to an analog PD controller. An A/D converter (4) transmits the position of the valve to the microcontroller (5). The PD controller compares this actual position to the 4 to 20 mA DC control signal (reference variable) after it has been converted by the A/D converter (4). In case of a set point deviation, the activation of the i/p converter (6) is changed so that the actuator of the control valve (1) is pressurized or vented accordingly over the downstream booster (7). As a result, the closure member of the valve (e.g. plug) is moved to the position determined by the set point.

The supply air is supplied to the booster (7) and the pressure regulator (8). An intermediate flow regulator (9) with fixed settings is used to purge the positioner and, at the same time, guarantees trouble-free operation of the booster. The output signal pressure supplied by the booster can be limited by software.

The volume restriction Q (10) is used to optimize the positioner.

The extended EXPERTplus diagnostics are integrated into the positioner. They provide information on the positioner and generate diagnostic and status messages, which allow faults to be pinpointed quickly.

### 3.1 Mounting versions

The positioner is suitable for the following types of attachment using the corresponding accessories (see section 3.4):

- **Direct attachment to SAMSON Type 3277 Actuator**  
→ See section 5.3.
- **Attachment to actuators according to IEC 60534-6:**  
→ See section 5.4.
- **Attachment according to VDI/VDE 3847-1/-2:**  
→ See section 5.5 and section 5.6.
- **Attachment to Type 3510 Micro-flow Valve**  
→ See section 5.7.
- **Attachment to rotary actuators according to VDI/VDE 3845:**  
→ See section 5.8.

### 3.2 Additional equipment

#### Solenoid valve

If the operating voltage for the solenoid valve (12) fails, the signal pressure for the booster is vented to the atmosphere. As a result, the actuator is vented and the valve moves to its fail-safe position.

---

#### **NOTICE**

*The manual set point is automatically reset to 0 % after the solenoid valve is activated. A different manual set point must be entered again (Code 1).*

---

#### Position transmitter

The position transmitter (13) is a two-wire transmitter and issues the travel sensor signal



as a 4 to 20 mA signal processed by the microcontroller.

Since this signal is issued independent of the positioner's input signal (minimum current 3.8 mA), the momentary travel/angle of rotation is controlled in real-time. Additionally, the position transmitter allows positioner faults to be indicated over a signal current of <2.4 mA or >21.6 mA.

### Inductive limit switch

In this version, the rotary shaft of the positioner carries an adjustable tag which actuates the built-in proximity switch. The optional inductive switch (11) is connected to A1, while the remaining software limit switch is connected to A2.

### External position sensor



In this version, only the sensor is mounted to the control valve. The positioner is located separately from the valve. The connection of x and y signals to the valve is established by cable and piping for air (only without inductive limit switch).

### Leakage sensor

By upgrading the positioner with a leakage sensor, it is possible to detect seat leakage when the valve is in the closed position.

### Binary input

Positioners can be optionally fitted with a binary input. The following actions can be triggered by changing the edge state:

- **Transmit switching state** [default]  
The switching state of the binary input is logged.
- **Set on-site operation write protection**  
While the binary input is active, no settings can be changed at the positioner. Enabling configuration over Code 3 is not active.
- **Switch between AUTO/MAN**  
The positioner changes from the automatic mode  (AUTO) to the manual mode  (MAN) or vice versa.  
This function is not performed if the positioner is in the fail-safe position mode (SAFE).
- Various diagnostic functions ► EB 8389 (EXPERTplus valve diagnostics)

---

#### Note

- *The optional binary input can only be configured using the TROVIS-VIEW software and using the DD parameters (► EB 8389 on EXPERTplus valve diagnostics).*
  - *The default switching state is with an open switch.*
- 

## 3.3 Configuration using the TROVIS-VIEW software

The positioner can be configured with SAMSON's TROVIS-VIEW Software.

The positioner has for this purpose a **serial interface** to allow the RS-232 or USB port of

## Design and principle of operation

a computer to be connected to it using an adapter cable.

The TROVIS-VIEW software enables the user to easily configure the positioner as well as view process parameters online.

---

### **i** Note

*TROVIS-VIEW provides a uniform user interface that allows users to configure and parameterize various SAMSON devices using device-specific database modules. The device module 3730-2 can be downloaded free of charge from our website at ► [www.samson.de](http://www.samson.de) > SERVICE & SUPPORT > Downloads > TROVIS-VIEW.*

*Further information on TROVIS-VIEW (e.g. system requirements) is available on our website and in the Data Sheet ► T 6661.*

---

## 3.4 Device overview and operating controls

→ See section 6.

### 3.5 Accessories

**Table 1:** General accessories

Designation		Order no.
Reversing amplifier for double-acting actuators		Type 3710
Cable gland M20x1.5	Black plastic (6 to 12 mm clamping range)	8808-1011
	Blue plastic (6 to 12 mm clamping range)	8808-1012
	Nickel-plated brass (6 to 12 mm clamping range)	1890-4875
	Nickel-plated brass (10 to 14 mm clamping range)	1922-8395
	Stainless steel 1.4305 (8 to 14.5 mm clamping range)	8808-0160
Adapter M20x1.5 to ½ NPT	Powder-coated aluminum	0310-2149
	Stainless steel	1400-7114
Lever	S	0510-0522
	M	0510-0510
	L	0510-0511
	XL	0510-0512
	XXL	0510-0525
Retrofit kit for inductive limit switch 1 x SJ2-SN		1402-1770
Isolated USB interface adapter (SAMSON SSP interface to USB port on a computer) including TROVIS-VIEW CD-ROM		1400-9740
Serial interface adapter (SAMSON SSP interface to RS-232 port on a computer)		1400-7700
TROVIS-VIEW 6661 (download available: ► <a href="http://www.samson.de">www.samson.de</a> > SERVICE & SUPPORT > Downloads > TROVIS-VIEW)		

**Table 2:** Direct attachment to Type 3277-5 (see section 5.3.1)

Designation		Order no.	
Mounting parts	Standard version for actuators 120 cm <sup>2</sup> or smaller	1400-7452	
	Version compatible with paint for actuators 120 cm <sup>2</sup> or smaller	1402-0940	
Accessories for actuator	Old switchover plate for Type 3277-5xxxxxx.00 Actuator (old)	1400-6819	
	New switchover plate for Type 3277-5xxxxxx.01 Actuator (new) <sup>1)</sup>	1400-6822	
	New connecting plate for Type 3277-5xxxxxx.01 Actuator (new) <sup>1)</sup> , G ¼ and ½ NPT	1400-6823	
	Old connecting plate for Type 3277-5xxxxxx.00 Actuator (old): G ¼	1400-6820	
	Old connecting plate for Type 3277-5xxxxxx.00 (old): ½ NPT	1400-6821	
Accessories for positioner	Connecting plate (6)	G ¼	1400-7461
		¼ NPT	1400-7462
	Pressure gauge bracket (7)	G ¼	1400-7458
		¼ NPT	1400-7459
	Pressure gauge mounting kit (8) up to max. 6 bar (output/supply)	Stainless steel/brass	1402-0938
		Stainless steel/stainless steel	1402-0939

<sup>1)</sup> Only new switchover and connecting plates can be used with new actuators (Index 01). Old and new plates are not interchangeable.

## Design and principle of operation

**Table 3:** Direct attachment to Type 3277 (see section 5.3.2)

Mounting parts/accessories		Order no.
Standard version for actuators 175, 240, 350, 355, 700, 750 cm <sup>2</sup>		1400-7453
Version compatible with paint for actuators 175, 240, 350, 355, 700, 750 cm <sup>2</sup>		1402-0941
Connection block with seals and screw	G ¼	1400-8819
	¼ NPT	1402-0901
Pressure gauge mounting kit up to max. 6 bar (output/supply)	Stainless steel/brass	1402-0938
	Stainless steel/stainless steel	1402-0939
Piping with screw fittings <sup>1)</sup>		Order no.
Actuator (175 cm <sup>2</sup> ), steel	G ¼/G ¾	1402-0970
	¼ NPT/¾ NPT	1402-0976
Actuator (175 cm <sup>2</sup> ), stainless steel	G ¼/G ¾	1402-0971
	¼ NPT/¾ NPT	1402-0978
Actuator (240 cm <sup>2</sup> ), steel	G ¼/G ¾	1400-6444
	¼ NPT/¾ NPT	1402-0911
Actuator (240 cm <sup>2</sup> ), stainless steel	G ¼/G ¾	1400-6445
	¼ NPT/¾ NPT	1402-0912
Actuator (350 cm <sup>2</sup> ), steel	G ¼/G ¾	1400-6446
	¼ NPT/¾ NPT	1402-0913
Actuator (350 cm <sup>2</sup> ), stainless steel	G ¼/G ¾	1400-6447
	¼ NPT/¾ NPT	1402-0914
Actuator (355 cm <sup>2</sup> ), steel	G ¼/G ¾	1402-0972
	¼ NPT/¾ NPT	1402-0979
Actuator (355 cm <sup>2</sup> ), stainless steel	G ¼/G ¾	1402-0973
	¼ NPT/¾ NPT	1402-0980
Actuator (700 cm <sup>2</sup> ), steel	G ¼/G ¾	1400-6448
	¼ NPT/¾ NPT	1402-0915
Actuator (700 cm <sup>2</sup> ), stainless steel	G ¼/G ¾	1400-6449
	¼ NPT/¾ NPT	1402-0916
Actuator (750 cm <sup>2</sup> ), steel	G ¼/G ¾	1402-0974
	¼ NPT/¾ NPT	1402-0981
Actuator (750 cm <sup>2</sup> ), stainless steel	G ¼/G ¾	1402-0975
	¼ NPT/¾ NPT	1402-0982

<sup>1)</sup> For "actuator stem retracts" fail-safe action with air purging of the top diaphragm chamber

**Table 4:** Attachment to NAMUR rib or attachment to rod-type yokes<sup>1)</sup> according to IEC 60534-6 (section 5.4)

Travel in mm	Lever	For actuator	Order no.
7.5	S	Type 3271-5 with 60/120 cm <sup>2</sup> on Type 3510 Micro-flow Valve	1402-0478
5 to 50	M <sup>2)</sup>	Actuators from other manufacturers and Type 3271 with 120 to 750 cm <sup>2</sup> effective areas	1400-7454
14 to 100	L	Actuators from other manufacturers and Type 3271 with 1000 and 1400-60 cm <sup>2</sup>	1400-7455
30 or 60	L	Type 3271, 1400-120 and 2800 cm <sup>2</sup> versions with 30/60 mm travel <sup>3)</sup>	1400-7466
		Mounting brackets for Emerson and Masoneilan linear actuators (in addition, a mounting kit according to IEC 60534-6 is required depending on the travel). See rows above.	1400-6771
		Valtek Type 25/50	1400-9554
40 to 200	XL	Actuators from other manufacturers and Type 3271 with 1400-120 and 2800 cm <sup>2</sup> and with 120 mm travel	1400-7456
Accessories			Order no.
Connecting plate	G ¼		1400-7461
	¼ NPT		1400-7462
Pressure gauge bracket	G ¼		1400-7458
	¼ NPT		1400-7459
Pressure gauge mounting kit up to max. 6 bar (output/supply)	Stainless steel/brass		1402-0938
	Stainless steel/stainless steel		1402-0939

1) 20 to 35 mm rod diameter

2) M lever is mounted on basic device (included in the scope of delivery)

3) In conjunction with Type 3273 Side-mounted Handwheel with 120 mm rated travel, additionally one bracket (0300-1162) and two countersunk screws (8330-0919) are required.

**Table 5:** Attachment according to VDI/VDE 3847-1 (see section 5.5)

Mounting parts			Order no.
VDI/VDE 3847 interface adapter			1402-0257
Connecting plate, including connection for air purging of actuator spring chamber	Aluminum	ISO 228/1-G ¼	1402-0268
		¼-18 NPT	1402-0269
	Stainless steel	ISO 228/1-G ¼	1402-0270
		¼-18 NPT	1402-0271
Mounting kit for attachment to SAMSON Type 3277 Actuator with 175 to 750 cm <sup>2</sup>			1402-0868
Mounting kit for attachment to SAMSON Type 3271 Actuator or non-SAMSON actuators			1402-0869
Travel pick-off for valve travel up to 100 mm			1402-0177
Travel pick-off for 100 to 200 mm valve travel (SAMSON Type 3271 Actuator only)			1402-0178

## Design and principle of operation

**Table 6:** Attachment according to VDI/VDE 3847-2 (see section 5.6)

Designation		Order no.
Mounting parts	Mounting block for PFEIFFER Type 31a (edition 2020+) Rotary Actuators with dummy plate for solenoid valve interface	1402-1645
	Dummy plate for solenoid valve interface (sold individually)	1402-1290
	Adapter bracket for Type 3730 (VDI/VDE 3847)	1402-0257
	Adapter bracket for Type 3730 and Type 3710 (DAP/PST)	1402-1590
Accessories for actuator	Shaft adapter AA1	1402-1617
	Shaft adapter AA2	1402-1616
	Shaft adapter AA4	1402-1888

**Table 7:** Attachment to rotary actuators (see section 5.8)

Mounting parts/accessories		Order no.	
Attachment according to VDI/VDE 3845 (September 2010), actuator surface corresponds to fixing level 1			
	Size AA1 to AA4, version with CrNiMo steel bracket	1400-7448	
	Size AA1 to AA4, heavy-duty version	1400-9244	
	Size AA5, heavy-duty version (e.g. Air Torque 10 000)	1400-9542	
	Bracket surface corresponds to fixing level 2, heavy-duty version	1400-9526	
	Attachment for rotary actuators with max. 180° opening angle, fixing level 2	1400-8815 and 1400-9837	
Attachment to SAMSON Type 3278 with 160/320 cm <sup>2</sup> , CrNiMo steel bracket		1400-7614	
Attachment to SAMSON Type 3278 with 160 cm <sup>2</sup> and to VETEC Type S160, Type R and Type M, heavy-duty version		1400-9245	
Attachment to SAMSON Type 3278 with 320 cm <sup>2</sup> and to VETEC Type S320, heavy-duty version		1400-5891 and 1400-9526	
Attachment to Camflex II		1400-9120	
Accessories	Connecting plate	G ¼	1400-7461
		¼ NPT	1400-7462
	Pressure gauge bracket	G ¼	1400-7458
		¼ NPT	1400-7459
	Pressure gauge mounting kit up to max. 6 bar (output/supply)	Stainless steel/brass	1402-0938
		Stainless steel/stainless steel	1402-0939

**Table 8:** Attachment of external position sensor (see section 5.10)

Mounting parts/accessories		Order no.	
Template for mounting position sensor on older mounting parts		1060-0784	
Direct attachment	Mounting parts for actuator with 120 cm <sup>2</sup>	1400-7472	
	Connecting plate (9, old) with Type 3277-5xxxxxx.00 Actuator	G 1/8	1400-6820
		1/8 NPT	1400-6821
	Connecting plate (new) with Type 3277-5xxxxxx.01 Actuator (new) <sup>1)</sup>	1400-6823	
Mounting parts for actuators with 175, 240, 350, 355 and 750 cm <sup>2</sup>		1400-7471	
NAMUR attachment	Mounting parts for attachment to NAMUR rib using L or XL lever	1400-7468	
Attachment to Type 3510 Micro-flow Valve	Mounting parts for Type 3271 Actuator with 60 cm <sup>2</sup>	1400-7469	
Attachment to rotary actuators	VDI/VDE 3845 (September 2010), see section 3.8 for details.		
	Actuator surface corresponds to fixing level 1		
	Size AA1 to AA4 with follower clamp and coupling wheel, version with CrNiMo steel bracket	1400-7473	
	Size AA1 to AA4, heavy-duty version	1400-9384	
	Size AA5, heavy-duty version (e.g. Air Torque 10 000)	1400-9992	
	Bracket surface corresponds to fixing level 2, heavy-duty version		1400-9974
SAMSON Type 3278 with 160 cm <sup>2</sup> and VETEC Type S160 and Type R, heavy-duty version		1400-9385	
SAMSON Type 3278 with 320 cm <sup>2</sup> and VETEC Type S320, heavy-duty version		1400-5891 and 1400-9974	
Accessories for positioner	Connecting plate (6)	G 1/4	1400-7461
		1/4 NPT	1400-7462
	Pressure gauge bracket (7)	G 1/4	1400-7458
		1/4 NPT	1400-7459
	Pressure gauge mounting kit up to max. 6 bar (output/supply)	Stainless steel/brass	1402-0938
		Stainless steel/stainless steel	1402-0939
Bracket to mount the positioner on a wall ( <b>Note:</b> The other fastening parts are to be provided at the site of installation as wall foundations vary from site to site).		0309-0184	

<sup>1)</sup> Only new connecting plates can be used with new actuators (Index 01). Old and new plates are not interchangeable.

### 3.5.1 Travel tables

**i Note**

The **M** lever is included in the scope of delivery.

**S, L, XL** levers for attachment according to IEC 60534-6 (NAMUR) are available as accessories (see Table 4 on page 25). The **XXL** lever is available on request.

**Table 9:** Direct attachment to Type 3277-5 and Type 3277 Actuator

Actuator size [cm <sup>2</sup> ]	Rated travel [mm]	Adjustment range at positioner <sup>1)</sup> Travel [mm]	Required lever	Assigned pin position
120	7.5	5.0 to 25.0	M	25
120/175/240/350	15	7.0 to 35.0	M	35
355/700/750	30	10.0 to 50.0	M	50

<sup>1)</sup> The min./max. adjustment range is based on the NOM (nominal range) initialization mode

**Table 10:** Attachment according to IEC 60534-6 (NAMUR)

SAMSON valves with Type 3271 Actuator		Adjustment range at positioner Other control valves <sup>1)</sup>		Required lever	Assigned pin position
Actuator size [cm <sup>2</sup> ]	Rated travel [mm]	Min. travel [mm]	Max. travel [mm]		
60 and 120 with Type 3510 Valve	7.5	3.6	18.0	S	17
120	7.5	5.0	25.0	M	25
120/175/240/350	15	7.0	35.0	M	35
355/700/750	7.5	7.0	35.0	M	35
355/700/750	15 and 30	10.0	50.0	M	50
1000/1400/2800	30	14.0	70.0	L	70
	60	20.0	100.0	L	100
1400/2800	120	40.0	200.0	XL	200
See manufacturer's specifications	200	See manufacturer's specifications			300

<sup>1)</sup> The min./max. adjustment range is based on the NOM (nominal range) initialization mode

**Table 11:** Attachment to rotary actuators

Opening angle	Required lever	Assigned pin position
24 to 100°	M	90°



### 3.6 Technical data

**Table 12:** Type 3730-2 Electropneumatic Positioner

Type 3730-2 Positioner		The technical data for the explosion-protected devices may be restricted by the limits specified in the test certificates.	
Valve travel	Adjustable	Direct attachment to Type 3277 Actuator	3.6 to 30 mm
		Attachment according to IEC 60534-6 (NAMUR)	3.6 to 300 mm
		Attachment according to VDI/VDE 3847	3.6 to 300 mm
		Attachment to rotary actuators (VDI/VDE 3845)	24 to 100° opening angle
Travel range	Adjustable	Adjustable within the initialized travel/angle of rotation of the valve; travel can be restricted to 1/5 at the maximum.	
Set point w	Signal range	4 to 20 mA · Two-wire device, reverse polarity protection · Minimum span 4 mA	
	Static destruction limit	100 mA	
Minimum current		3.6 mA for display · 3.8 mA for operation	
Load impedance		Without explosion protection: $\leq 6$ V (corresponding to 300 $\Omega$ at 20 mA) Explosion protection: $\leq 7$ V (corresponding to 350 $\Omega$ at 20 mA)	
Supply air		1.4 to 7 bar (20 to 105 psi)	
Air quality acc. to ISO 8573-1		Max. particle size and density: Class 4 · Oil content: Class 3 · Pressure dew point: Class 3 or at least 10 K below the lowest ambient temperature to be expected	
Signal pressure (output)		0 bar up to the supply pressure · Can be limited to 1.4 bar/2.4 bar/3.7 bar $\pm$ 0.2 bar by software	
Characteristic	Adjustable	Linear/Equal percentage/Reverse equal percentage User-defined (over operating software and communication) Butterfly valve, rotary plug valve and segmented ball valve: Linear/equal percentage	
	Deviation	$\leq 1$ %	
Hysteresis		$\leq 0.3$ %	
Sensitivity		$\leq 0.1$ %	
Transit time		Venting or filling with air adjustable separately up to 240 s by software	
Direction of action		Reversible	
Air consumption, steady state		Independent of supply air approx. 110 $l_n/h$	
Air output capacity	To fill actuator with air	At $\Delta p = 6$ bar: 8.5 $m_n^3/h$ · At $\Delta p = 1.4$ bar: 3.0 $m_n^3/h$ · $K_{Vmax(20^\circ C)} = 0.09$	
	To vent actuator	At $\Delta p = 6$ bar: 14.0 $m_n^3/h$ · At $\Delta p = 1.4$ bar: 4.5 $m_n^3/h$ · $K_{Vmax(20^\circ C)} = 0.15$	
Permissible ambient temperature		-20 to +80 °C All versions -45 to +80 °C With metal cable gland <b>The temperature limits for the explosion-protected devices may be restricted by the limits specified in the test certificates.</b>	

## Design and principle of operation

<b>Type 3730-2 Positioner</b>		<b>The technical data for the explosion-protected devices may be restricted by the limits specified in the test certificates.</b>	
Influences	Temperature	≤0.15 %/10 K	
	Supply air	None	
	Effect of vibration	≤ 0.25 % up to 2000 Hz and 4 g according to IEC 770	
Electromagnetic compatibility		Complying with EN 61000-6-2, EN 61000-6-3, EN 61326-1 and NAMUR Recommendation NE 21	
Electrical connections		One M20x1.5 cable gland for 6 to 12 mm clamping range Second M20x1.5 threaded connection additionally available Screw terminals for 0.2 to 2.5 mm <sup>2</sup> wire cross-section	
Degree of protection		IP 66/NEMA 4X	
Use in safety-instrumented systems (SIL)		Observing the requirements of IEC 61508, the systematic capability of the pilot valve for emergency venting as a component in safety-instrumented systems is given.	
Emergency venting at 0 mA set point and using optional solenoid valve		Use is possible on observing the requirements of IEC 61511 and the required hardware fault tolerance in safety-instrumented systems up to SIL 2 (single device/HFT = 0) and SIL 3 (redundant configuration/HFT = 1).	
Explosion protection		Refer to Table 14	
Communication (local)		SAMSON SSP interface and serial interface adapter	
Software requirements (SSP)		TROVIS-VIEW with database module 3730-2	
<b>Binary contacts</b>			
For connection to		For connection to the binary input of the PLC acc. to IEC 61131-2, P <sub>max</sub> = 400 mW or for connection to NAMUR switching amplifier acc. to EN 60947-5-6	NAMUR switching amplifier acc. to EN 60947-5-6
Two software limit switches, reverse polarity protection, floating, configurable switching characteristics (default settings in table)			
Signal state	<b>Version</b>	<b>No explosion protection</b>	<b>Ex</b>
	No response	Blocked	≤1.0 mA
	Response	Conductive (R = 348 Ω)	≥2.2 mA
One fault alarm contact, floating			
Signal state	<b>Version</b>	<b>No explosion protection</b>	<b>Ex</b>
	No fault alarm	Conductive (R = 348 Ω)	≥2.2 mA
	Fault alarm	Blocked	≤1.0 mA
<b>Materials</b>			
Housing		Die-cast aluminum EN AC-ALSi12(Fe) (EN AC-44300) acc. to DIN EN 1706, chromated and powder paint coated · Special version: stainless steel 1.4408	
External parts		Stainless steel 1.4404/316L	

<b>Type 3730-2 Positioner</b>	<b>The technical data for the explosion-protected devices may be restricted by the limits specified in the test certificates.</b>
Cable gland	M20x1.5, black polyamide
Weight	Die-cast aluminum housing: approx. 1.0 kg Stainless steel housing: approx. 2.2 kg
Compliance	<b>CE · EAC</b>









**Table 13:** *Optional additional functions*

<b>Options for Type 3730-2 Positioner</b>	
<b>Solenoid valve · Approval acc. to IEC 61508/SIL</b>	
Input	24 V DC · Reverse polarity protection · Static destruction limit 40 V Current consumption $I = \frac{U - 5.7 \text{ V}}{3840 \Omega}$ (corresponding to 4.8 mA at 24 V/114 mW)
Signal '0' (no response)	<12 V (emergency shutdown at 0 V)
Signal '1' (response)	> 19 V
Service life	>5 × 10 <sup>6</sup> switching cycles
K <sub>v</sub> coefficient	0.15
<b>Analog position transmitter</b>	
Auxiliary power	12 to 30 V DC · Reverse polarity protection · Static destruction limit 40 V
Output signal	4 to 20 mA
Operating direction	Reversible
Operating range	-10 to +114 %
Characteristic	Linear
Hysteresis	Same as positioner
High-frequency influence	Same as positioner
Other influences	Same as positioner
Fault alarm	Can be issued as current signal 2.4 ±0.1 mA or 21.6 ±0.1 mA




## Design and principle of operation

<b>Options for Type 3730-2 Positioner</b>		
<b>Inductive limit switch by Pepperl+Fuchs</b>		
For connection to switching amplifier according to EN 60947-5-6. Can be used in combination with a software limit switch.		
SJ2-SN proximity switch	Measuring plate not detected: $\geq 3$ mA · Measuring plate detected: $\leq 1$ mA	
<b>External position sensor</b>		
Valve travel	Same as positioner	
Cable	10 m · Flexible and durable · With M12x1 connector · Flame-retardant acc. to VDE 0472 Resistant to oils, lubricants and coolants as well as other aggressive media	
Permissible ambient temperature	-40 to +90 °C with a fixed connection between positioner and position sensor · The limits in the test certificate additionally apply for explosion-protected versions.	
Immunity to vibration	Up to 10 g in the range of 10 to 2000 Hz	
Degree of protection	IP 67	
<b>Leakage sensor</b> · Suitable for operation in hazardous areas		
Temperature range	-40 to +130 °C	
Tightening torque	20 $\pm$ 5 Nm	
<b>Binary input</b> · Galvanically isolated · Switching behavior configured by software (e.g. TROVIS-VIEW, DTM)		
Active switching behavior (default setting)		
Connection	For external switch (floating contact) or relay contact	
Electric data	Open-circuit voltage when contact is open: max. 10 V Pulsed DC current reaching peak value of 100 mA and RMS value of 0.01 mA when contact is closed	
Contact	Closed, $R < 20 \Omega$	ON switching state (default setting)
	Open, $R > 400 \Omega$	OFF switching state (default setting)
Passive switching behavior		
Connection	For externally applied DC voltage, reverse polarity protection	
Electric data	3 to 30 V · Static destruction limit 40 V · Current consumption 3.7 mA at 24 V	
Voltage	$> 6$ V	ON switching state (default setting)
	$< 1$ V	OFF switching state (default setting)

**Table 14:** Summary of explosion protection approvals

Type	Certification			Type of protection/comments
3730-2		Number	PTB 00 ATEX 2158	II 2G Ex ia IIC T6 Gb, II 2D Ex ia IIIC T80°C Db
		Date	2016-08-17	
		Number	RU-C-DE 08 B.00697	1Ex ia IIC T6/T5/T4 Gb X; Ex tb III T 80°C Db X
		Date	2014-12-15	
		Valid until	2019-12-14	
		Number	IECEX PTB 05.0007	Ex ia IIC T6...T4 Gb; Ex ia IIIC T80°C Db
Date		2016-11-29		
	Number	11-KB4BO-0214	Ex ia IIC T6/T5/T4	
	Date	2011-10-24		
	Valid until	2019-10-24		
	Number	GYJ14.1286	Ex ia IIC T4...T6 Gb	
	Date	2014-11-05		
	Valid until	2019-11-04		
	Number	ZETC/16/2018	II 2G Ex ia IIC T6 Gb, II 2D Ex ia IIIC T80°C Db	
	Date	2018-04-27		
	Valid until	2021-04-26		
-23		Number	1330129	Ex ia IIC T6, Class I Zone 0; Class I, II, Groups A, B, C, D, E, F, G; Class I, Zone 2; Class I, II, Div. 2, Groups A, B, C, D, E, F, G; Class III; Type 4 Enclosure
		Date	2017-05-24	
		Number	ID 3012394	Class I, Zone 0 AEx ia IIC; Class I, II, III, Div.1, Groups A, B, C, D, E, F, G; Class I, Div.2, Groups A, B, C, D; Class II, III, Div.2, Groups F, G; Type 4X
		Date	2011-08-11	

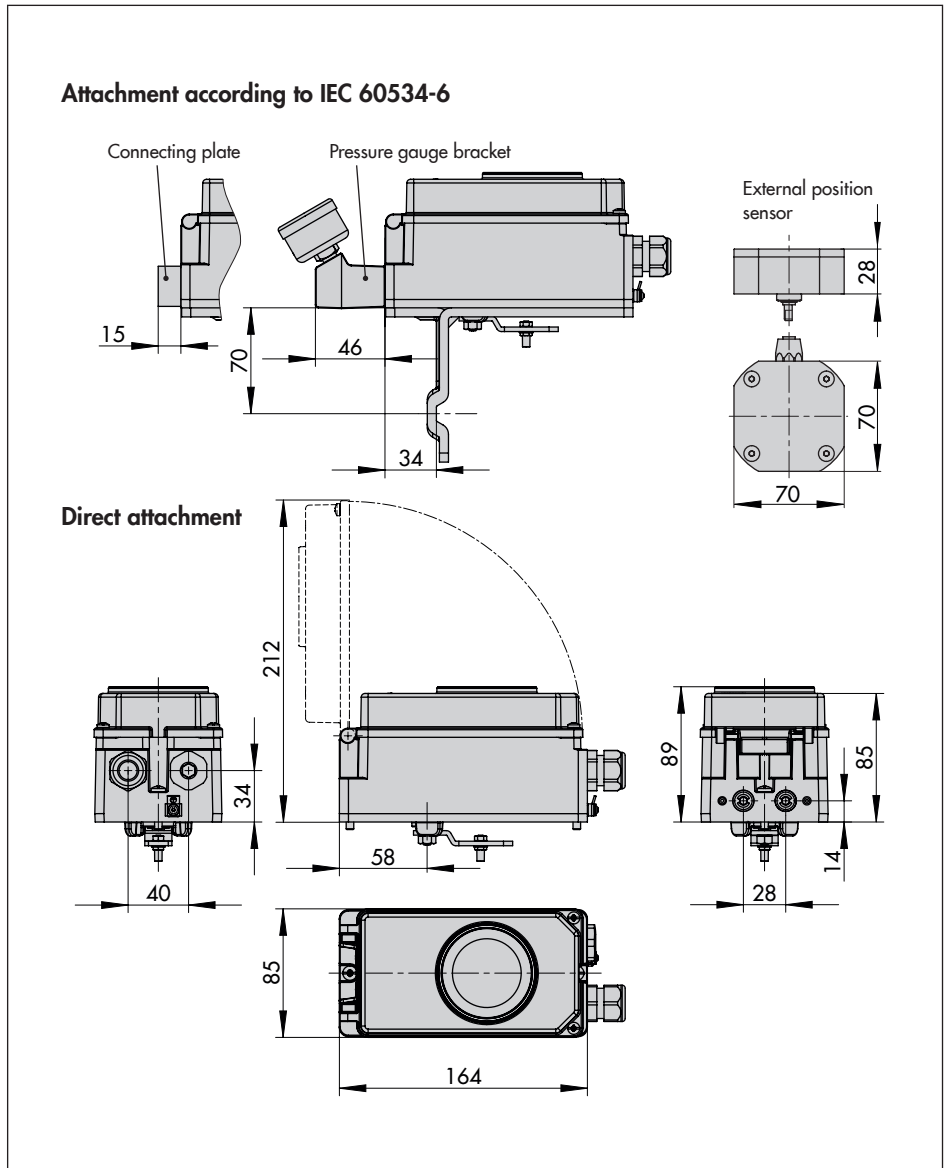
## Design and principle of operation

Type	Certification			Type of protection/comments
25	 <sup>1)</sup>	Number	PTB 00 ATEX 21 58	II 2D Ex tb IIIC T80°C Db
		Date	2016-08-17	
	<b>IECEX</b>	Number	IECEX PTB 05.0007	Ex tb IIIC T80°C Db
3730-2	<b>STCC</b>	Number	ZETC/16/2018	II 2D Ex tb IIIC T80°C Db
		Date	2018-04-27	
	Valid until	2021-04-26		
	<b>JIS</b>	Number	TC18159	Ex ia IIC T6
		Valid until	2019-11-26	
-28	 <sup>2)</sup>	Number	PTB 03 ATEX 2016 X	II 3G Ex nA IIC T6 Dc, II 3D Ex tc IIIC T80°C Dc
		Date	2016-08-31	
		Number	RU-C-DE 08 B.00697	2Ex nA IIC T6/T5/T4 Gc X
		Date	2014-12-15	2Ex ic IIC T6/T5/T4 Gc X
		Valid until	2019-12-14	Ex tc IIIC T 80°C Dc X
<b>IECEX</b>	Number	IECEX PTB 05.0007	Ex nA IIC T6...T4 Gc; Ex tc IIIC T80°C Dc	
<b>NEPSI</b>	Number	GYJ14.1287X	Ex ic IIC T4...T6 Gc	
	Date	2014-11-05	Ex nA IIC T4...T6 Gc	
<b>STCC</b>	Number	ZETC/16/2018	II 3G Ex nA IIC T6 Gc, II 3D Ex tc IIIC T80°C Dc	
	Date	2018-04-27		
	Valid until	2021-04-26		

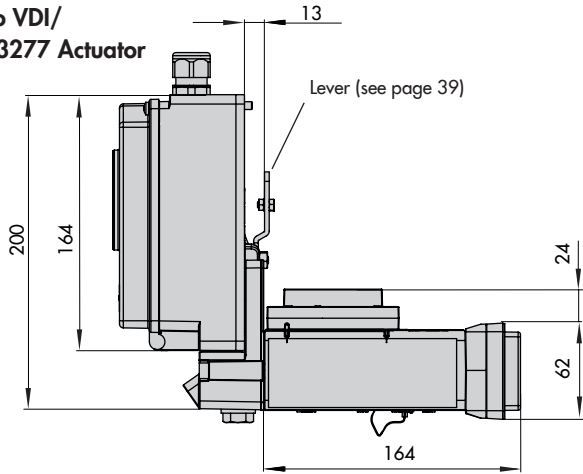
1) EC type examination certificate

2) Statement of conformity

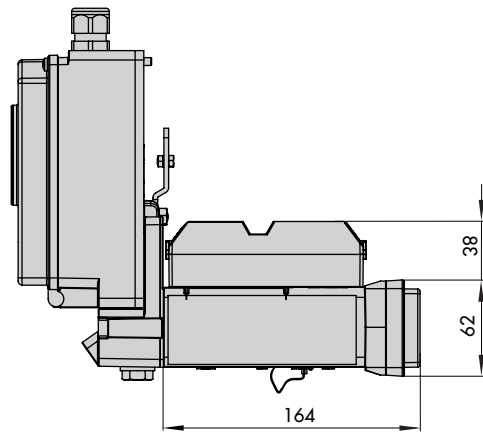
### 3.7 Dimensions in mm



**Attachment according to VDI/  
VDE 3847-1 onto Type 3277 Actuator**

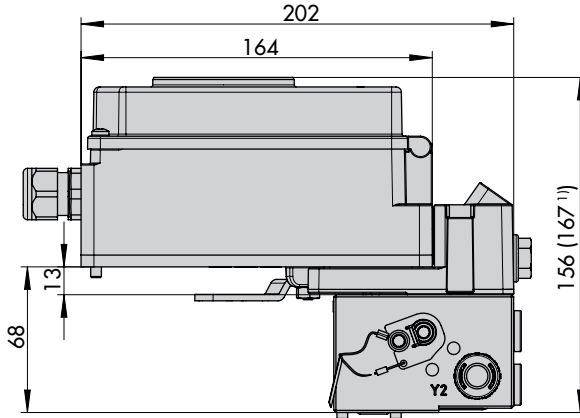


**Attachment according to VDI/  
VDE 3847-1 to a NAMUR rib**

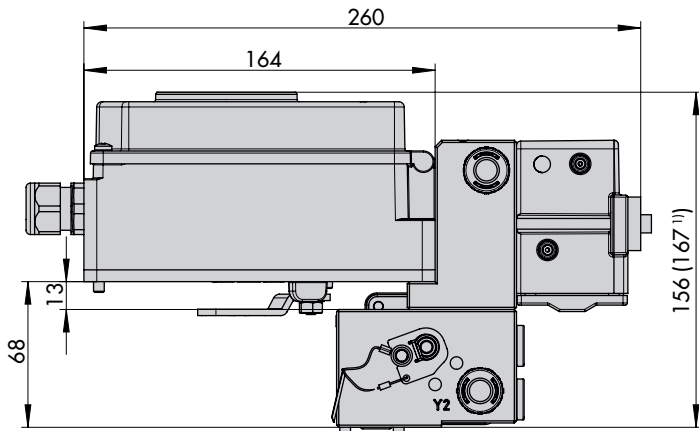




**Attachment according to VDI/VDE 3847-2  
with single-acting actuator**

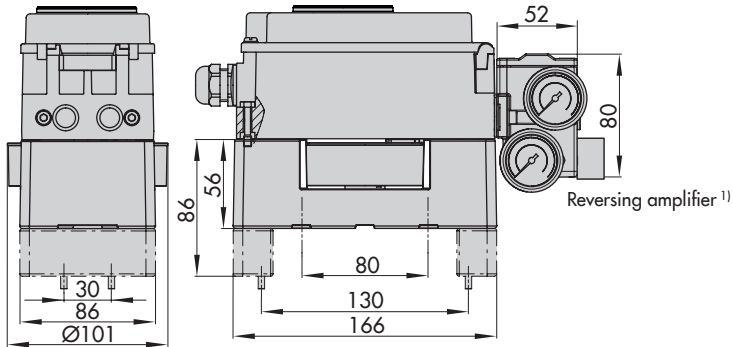


**Attachment according to VDI/VDE 3847-2  
with double-acting actuator**

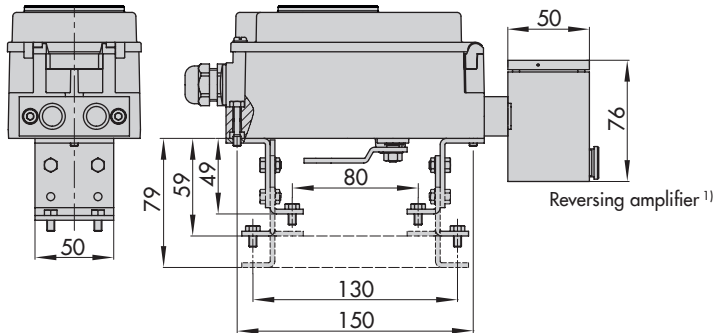


Attachment to rotary actuators according to VDI/VDE 3845

Heavy-duty version

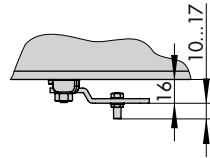
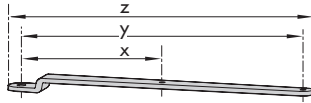


Light version



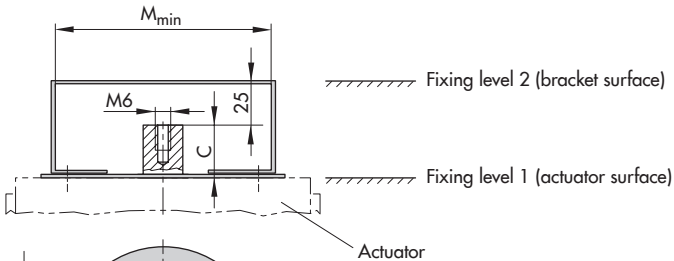
- <sup>1)</sup> Reversing amplifier  
– Type 3710 (see drawing of heavy-duty version for dimensions)  
– 1079-1118/1079-1119, no longer available  
(see drawing of light version for dimensions)

Lever



Lever	x	y	z
S	17 mm	25 mm	33 mm
M	25 mm	50 mm	66 mm
L	70 mm	100 mm	116 mm
XL	100 mm	200 mm	216 mm
XXL	200 mm	300 mm	316 mm

### 3.8 Fixing levels according to VDI/VDE 3845 (September 2010)



Dimensions in mm						
Size	A	B	C	$\varnothing d$	$M_{min}$	D <sup>1)</sup>
AA0	50	25	15	5.5 for M5	66	50
AA1	80	30	20	5.5 for M5	96	50
AA2	80	30	30	5.5 for M5	96	50
AA3	130	30	30	5.5 for M5	146	50
AA4	130	30	50	5.5 for M5	146	50
AA5	200	50	80	6.5 for M6	220	50

<sup>1)</sup> Flange type F05 acc. to DIN EN ISO 5211



## 4 Measures for preparation

After receiving the shipment, proceed as follows:

1. Check the scope of delivery. Compare the shipment received with the delivery note.
2. Check the shipment for transportation damage. Report any transportation damage.

### 4.1 Unpacking

#### ⓘ NOTICE

*Risk of positioner damage due to foreign particles entering it.*

*Do not remove the packaging and protective film/protective caps until immediately before mounting and start-up.*

1. Remove the packaging from the positioner.
2. Dispose of the packaging in accordance with the valid regulations.

### 4.2 Transporting

- Protect the positioner against external influences (e.g. impact).
- Protect the positioner against moisture and dirt.
- Observe transport temperature depending on the permissible ambient temperature (see technical data in section 3.6).

### 4.3 Storage

#### ⓘ NOTICE

*Risk of positioner damage due to improper storage.*

- *Observe the storage instructions.*
- *Contact SAMSON in case of different storage conditions or long storage periods.*

#### Storage instructions

- Protect the positioner against external influences (e.g. impact, shocks, vibration).
- Do not damage the corrosion protection (coating).
- Protect the positioner against moisture and dirt. In damp spaces, prevent condensation. If necessary, use a drying agent or heating.
- Observe storage temperature depending on the permissible ambient temperature (see technical data in section 3.6).
- Store positioner with closed cover.
- Seal the pneumatic and electrical connections.



## 5 Mounting and start-up

### ⓘ NOTICE

Risk of malfunction due to incorrect mounting parts/accessories.

Only use the mounting parts and accessories listed in these mounting and operating instructions to mount and install the positioner. Pay attention to the type of attachment.

### ⓘ NOTICE

Risk of malfunction due to incorrect sequence of mounting, installation and start-up. Observe the prescribed sequence.

→ Sequence:

**1. Remove the protective caps from the pneumatic connections.**

**2. Mount the positioner on the valve.**

→ Section 5.3 onward

**3. Perform pneumatic installation.**

→ Section 5.15 onward

**4. Perform electrical installation.**

→ Section 5.16 onward

**5. Perform settings.**

→ Section 7 onward

### 5.1 Mounting position

#### ⓘ NOTICE

Risk of damage to the positioner due to incorrect mounting position.

- Do not mount the positioner with the back of the device facing upward.
- Do not seal or restrict the vent opening when the device is installed on site.

→ Observe mounting position (see Fig. 3).

→ Do not seal or restrict the vent opening (see Fig. 2) when the device is installed on site.

### 5.2 Lever and pin position

The positioner is adapted to the actuator and to the rated travel by the lever on the back of the positioner and the pin inserted into the lever.

The travel tables on page 28 show the maximum adjustment range at the positioner. The travel that can be implemented at the valve is additionally restricted by the selected fail-safe position and the required compression of the actuator springs.

The positioner is equipped with the M lever (pin position 35) as standard (see Fig. 4).

#### ⓘ Note

The **M** lever is included in the scope of delivery.

**S, L, XL** levers are available as accessories.

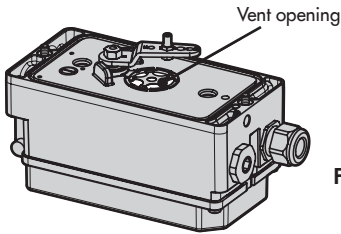
The **XXL** lever is available on request.

## Mounting and start-up

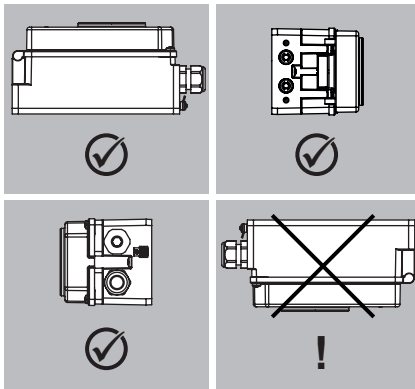
If a pin position other than position **35** with the standard **M** lever is required or an **L** or **XL** lever size is required, proceed as follows (see Fig. 5):

1. Fasten the follower pin (2) in the assigned lever hole (pin position as specified in the travel tables on page 28).  
Only use the longer follower pin included in the mounting kit.
2. Place the lever (1) on the shaft of the positioner and fasten it tight using the disk spring (1.2) and nut (1.1).

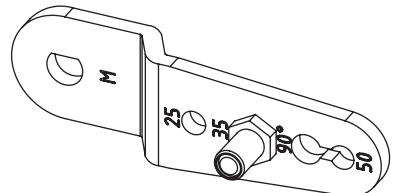




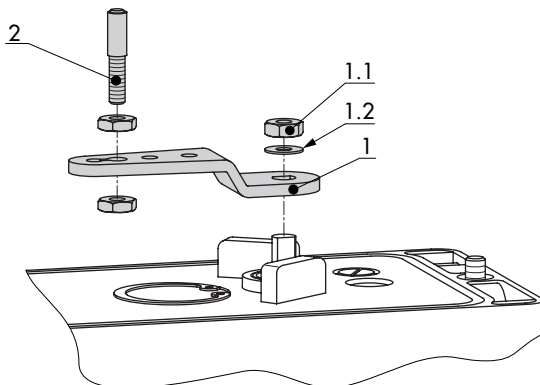
**Fig. 2:** Vent opening  
(back of the positioner)



**Fig. 3:** Permissible mounting  
positions



**Fig. 4:** M lever with pin position 35



- 1 Lever
- 1.1 Nut
- 1.2 Disk spring
- 2 Follower pin

**Fig. 5:** Mounting the lever  
and follower pin

### 5.3 Direct attachment

#### 5.3.1 Type 3277-5 Actuator

- ➔ Required mounting parts and accessories: Table 2 on page 23.
- ➔ Observe travel tables on page 28.

##### Actuator with 120 cm<sup>2</sup> (see Fig. 6)

Depending on the type of positioner attachment, the signal pressure is routed either left or right of the yoke through a hole to the actuator diaphragm. Depending on the fail-safe action of the actuator "actuator stem extends" or "actuator stem retracts" (valve closes or opens upon supply air failure), the switchover plate (9) must first be attached to the actuator yoke. Align the switchover plate with the corresponding symbol for left or right attachment according to the marking (view looking onto the switchover plate).

1. Mount connecting plate (6) or pressure gauge bracket (7) with pressure gauges on the positioner, making sure the two seals (6.1) are seated properly.
2. Remove screw plug (4) on the back of the positioner and seal the signal pressure output (38) on the connecting plate (6) or on the pressure gauge bracket (7) with the stopper (5) included in the accessories.
3. Place follower clamp (3) on the actuator stem, align it and screw tight so that the mounting screw is located in the groove of the actuator stem.
4. Mount cover plate (10) with narrow side of the cut-out (Fig. 6, on the left) pointing towards the signal pressure connection.

Make sure that the gasket (14) points towards the actuator yoke.

5. **15 mm travel:** Keep the follower pin (2) on the M lever (1) on the back of the positioner in the pin position 35 (delivered state).  
**7.5 mm travel:** Remove the follower pin (2) from the pin position 35, reposition it in the hole for pin position 25 and screw tight.
6. Insert formed seal (15) into the groove of the positioner housing and insert the seal (10.1) on the back of the housing.
7. Place positioner on the cover plate (10) in such a manner that the follower pin (2) rests on the top of the follower clamp (3). Adjust the lever (1) correspondingly and open the positioner cover to hold the positioner shaft in position at the cap or rotary pushbutton. The lever (1) must rest on the follower clamp with spring force. Mount the positioner on the cover plate (10) using the two fixing screws.

---

#### **i** Note

*The following applies to all types of attachment except for direct attachment to Type 3277-5: the signal pressure output at the back must be sealed by the screw plug (4, order no. 0180-1436) and the associated O-ring (order no. 0520-0412) (delivered state, parts included in the scope of delivery).*

---

8. Mount cover (11) on the other side. Make sure that the vent plug is located at the bottom when the control valve is in-

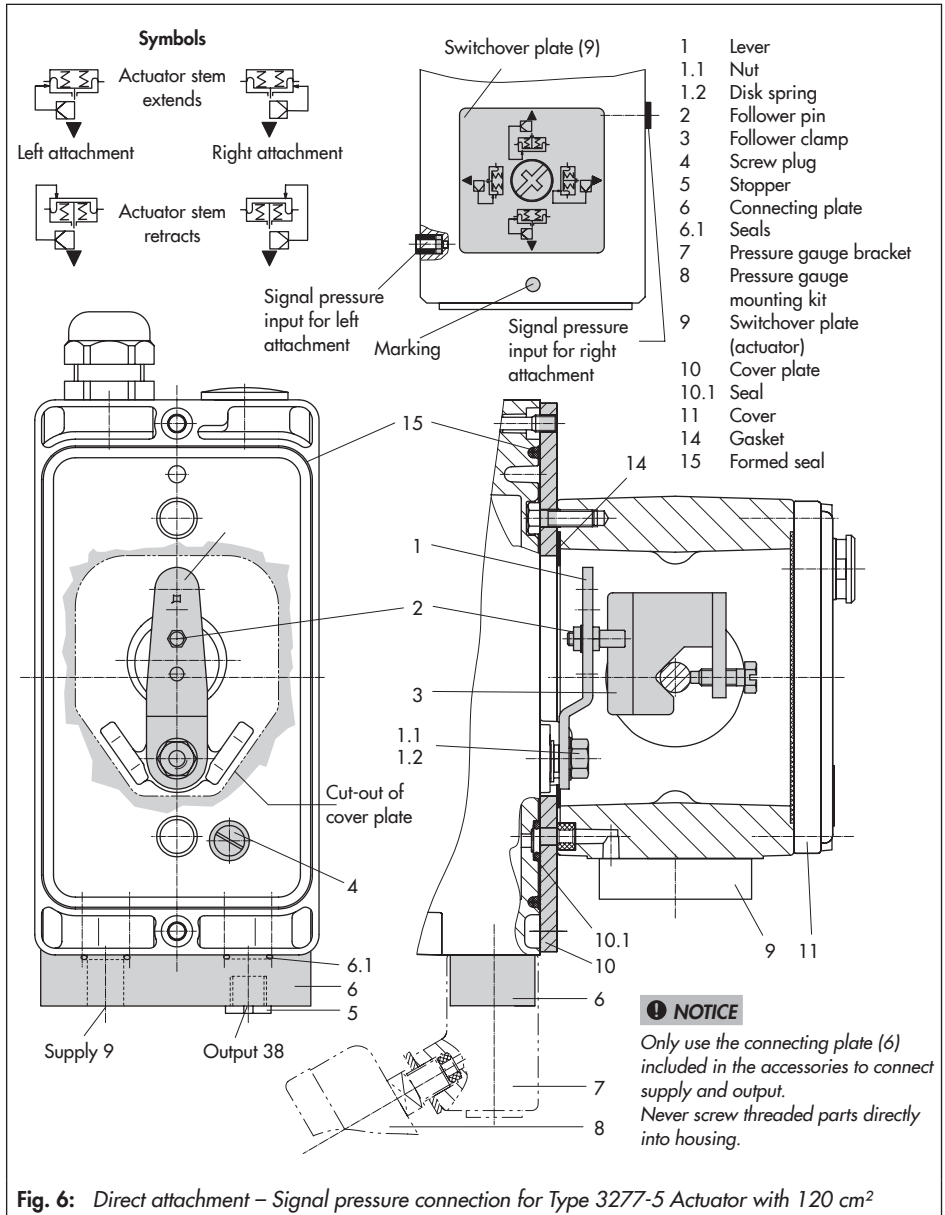


Fig. 6: Direct attachment – Signal pressure connection for Type 3277-5 Actuator with 120 cm<sup>2</sup>

## Mounting and start-up

stalled to allow any condensed water that collects to drain off.

### 5.3.2 Type 3277 Actuator

→ Required mounting parts and accessories: Table 3 on page 24.

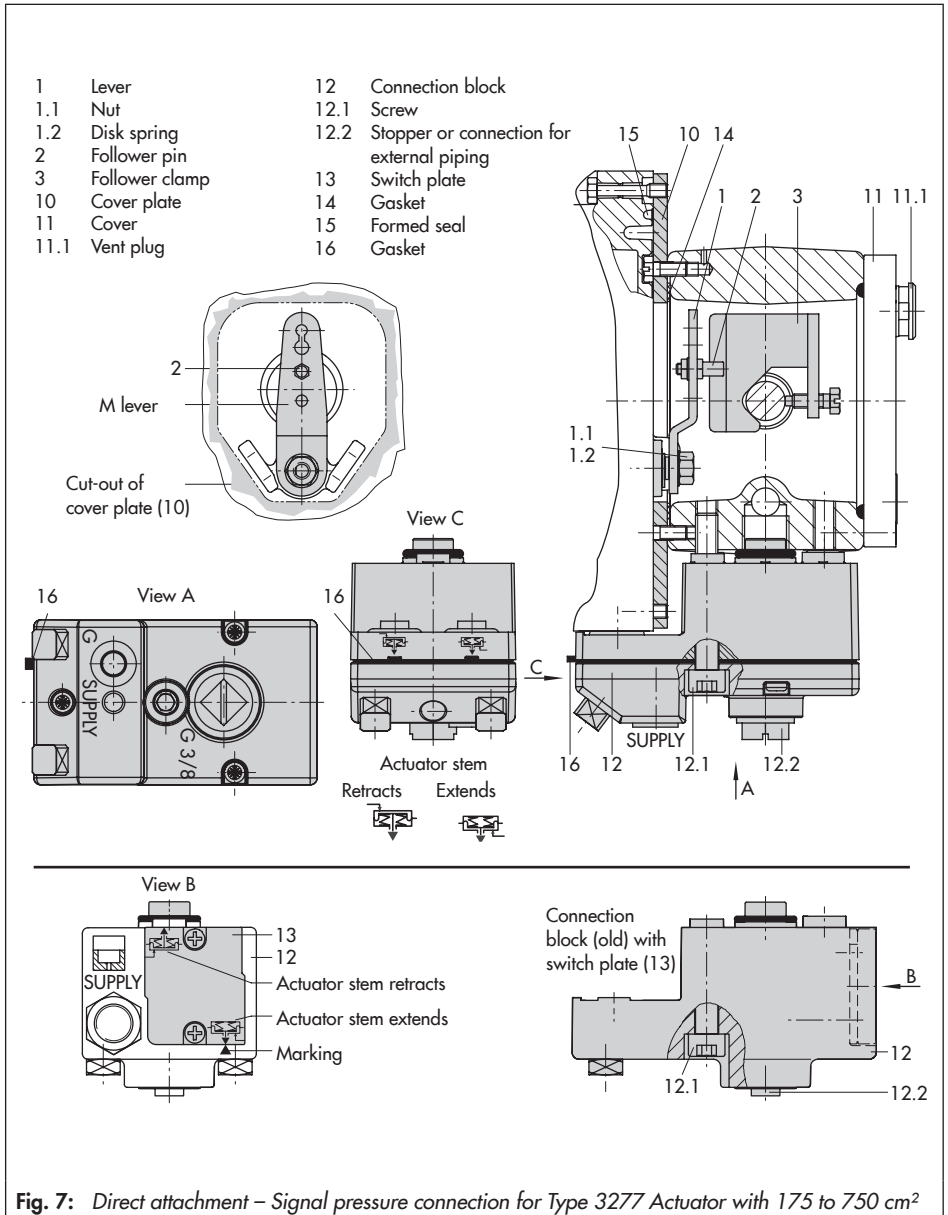
→ Observe travel tables on page 28.

#### Actuators with 175 to 750 cm<sup>2</sup> effective areas (see Fig. 7)

Mount the positioner on the yoke. The signal pressure is routed to the actuator over the connection block (12), for actuators with fail-safe action "actuator stem extends" internally through a hole in the valve yoke and for "actuator stem retracts" through an external pipe.

1. Place follower clamp (3) on the actuator stem, align it and screw tight so that the mounting screw is located in the groove of the actuator stem.
2. Mount cover plate (10) with narrow side of the cut-out (Fig. 7, on the left) pointing towards the signal pressure connection. Make sure that the gasket (14) points towards the actuator yoke.
3. For actuators with 355, 700 or 750 cm<sup>2</sup>, remove the follower pin (2) on the **M** lever (1) on the back of the positioner from pin position **35**, reposition it in the hole for pin position **50** and screw tight. For actuators 175, 240 and 350 cm<sup>2</sup> with 15 mm travel, keep the follower pin (2) in pin position **35**.
4. Insert formed seal (15) into the groove of the positioner housing.

5. Place positioner on the cover plate in such a manner that the follower pin (2) rests on the top of the follower clamp (3). Adjust the lever (1) correspondingly and open the positioner cover to hold the positioner shaft in position at the cap or rotary pushbutton. The lever (1) must rest on the follower clamp with spring force. Mount the positioner on the cover plate (10) using the two fixing screws.
6. Make sure that the tip of the gasket (16) projecting from the side of the connection block is positioned to match the actuator symbol for the actuator's fail-safe action "actuator stem extends" or "actuator stem retracts". If this is not the case, unscrew the three fastening screws and lift off the cover. Turn the gasket (16) by 180° and re-insert it.  
The old connection block version (Fig. 7, bottom) requires the switch plate (13) to be turned to align the actuator symbol with the arrow marking.
7. Place the connection block (12) with the associated seals against the positioner and the actuator yoke and fasten using the screw (12.1). For actuators with fail-safe action "actuator stem retracts", additionally remove the stopper (12.2) and mount the external signal pressure pipe.
8. Mount cover (11) on the other side. Make sure that the vent plug is located at the bottom when the control valve is installed to allow any condensed water that collects to drain off.



### 5.4 Attachment according to IEC 60534-6

- Required mounting parts and accessories: Table 4 on page 25.
- Observe travel tables on page 28.
- Refer to Fig. 8

The positioner is attached to the control valve using a NAMUR bracket (10).

1. Screw the two bolts (14) to the bracket (9.1) of the stem connector (9), place the follower plate (3) on top and use the screws (14.1) for fastening.

#### Actuator sizes 2800 cm<sup>2</sup> and 1400 cm<sup>2</sup> with 120 mm travel:

- For a travel of 60 mm or smaller, screw the longer follower plate (3.1) directly to the stem connector (9).
  - For a travel exceeding 60 mm, mount the bracket (16) first and then the follower plate (3) to the bracket together with the bolts (14) and screws (14.1).
2. Mount NAMUR bracket (10) to the control valve as follows:
    - For **attachment to the NAMUR rib**, use an M8 screw (11) and toothed lock washer directly in the yoke hole.
    - For attachment to **valves with rod-type yokes**, use two U-bolts (15) around the yoke. Align the NAMUR bracket (10) according to the embossed scale so that the follower plate (3) is shifted by half the angle range to the NAMUR bracket (the

slot of the follower plate is centrally aligned with the NAMUR bracket at mid valve travel).

3. Mount connecting plate (6) or pressure gauge bracket (7) with pressure gauges on the positioner, making sure the two seals (6.1) are seated properly.
4. Select required lever size (1) M, L or XL and pin position according to the actuator size and valve travel listed in the travel table on page 28.

Should a pin position other than position **35** with the standard **M** lever be required or an **L** or **XL** lever size be required, proceed as follows:

- Fasten the follower pin (2) in the assigned lever hole (pin position as specified in the travel table). Only use the longer follower pin (2) included in the mounting kit.
  - Place the lever (1) on the shaft of the positioner and fasten it tight using the disk spring (1.2) and nut (1.1). Move lever once all the way as far as it will go in both directions.
5. Place positioner on the NAMUR bracket in such a manner that the follower pin (2) rests in the slot of the follower plate (3, 3.1). Adjust the lever (1) correspondingly.  
Screw the positioner to the NAMUR bracket using its two fastening screws.

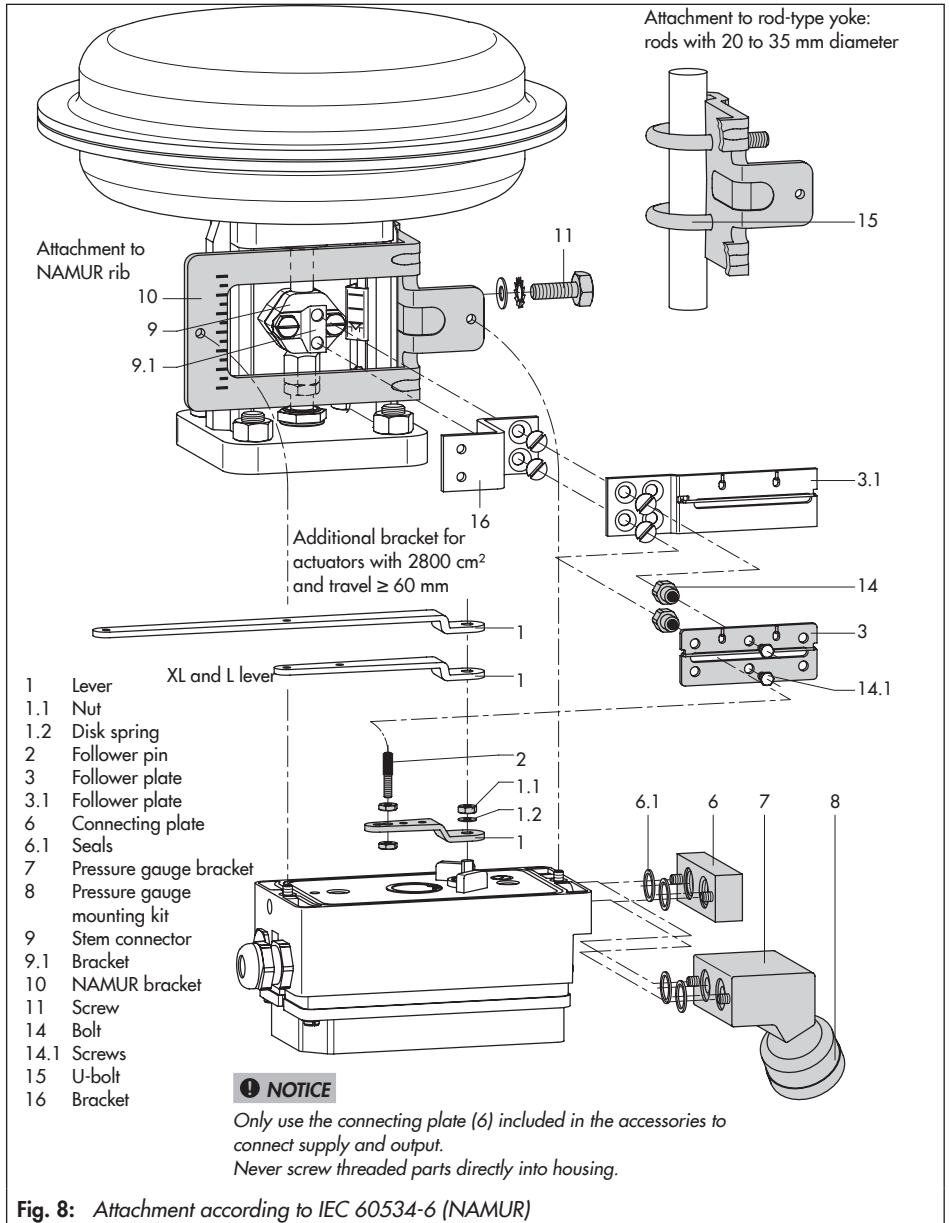


Fig. 8: Attachment according to IEC 60534-6 (NAMUR)

### 5.5 Attachment according to VDI/VDE 3847-1

The Type 3730-2xxx0xxxx0x0060xx and Type 3730-2xxxxxx0xx0700 Positioners with air purging of the actuator's spring chamber can be attached according to VDI/VDE 3847.

The Type 3730-2xxx0xxxx0x0000xx Positioner without air purging of the actuator's spring chamber can be attached according to VDI/VDE 3847.

This type of attachment allows the positioner to be replaced quickly while the process is running by blocking the air in the actuator.

The signal pressure can be blocked in the actuator by unscrewing the red retaining screw (20) and turning the air blocker (19) on the bottom of the adapter block.

#### Attachment to Type 3277 Actuator (see Fig. 9)

→ Required mounting parts and accessories: Table 5 on page 25.

Mount the positioner on the yoke. The signal pressure is routed to the actuator over the connecting plate (12), for actuators with fail-safe action "actuator stem extends" internally through a bore in the valve yoke and for "actuator stem retracts" through external piping.

Only the Y1 port is required for positioner attachment. The Y2 port can be used for air purging of the spring chamber.

1. Place follower clamp (3) on the actuator stem, align it and screw tight so that the

mounting screw is located in the groove of the actuator stem.

2. Place the adapter bracket (6) on the positioner and mount using the screws (6.1). Make sure that the seals are correctly seated. For positioners **with air purging**, remove the stopper (5) before mounting the positioner. For positioners **without air purging**, replace the screw plug (4) with a vent plug.
3. For actuators with 355, 700 or 750 cm<sup>2</sup>, remove the follower pin (2) on the M lever (1) on the back of the positioner from pin position 35, reposition it in the hole for pin position 50 and screw tight.

For actuators 175, 240 and 350 cm<sup>2</sup> with 15 mm travel, keep the follower pin (2) in pin position 35.

4. Insert the formed seal (6.2) in the groove of the adapter bracket (6).
5. Insert the formed seal (17.1) into the turnboard (17) and mount the turnboard to the adapter block (13) using the screws (17.2).
6. Mount the blank plate (18) to the turnboard (17) using the screws (18.1). Make sure that the seals are correctly seated.

---

#### **i** Note

*A solenoid valve can also be mounted in place of the blank plate (18). The orientation of the turnboard (17) determines the mounting position of the solenoid valve. Alternatively, a restrictor plate can be mounted (▶ AB 11).*

---



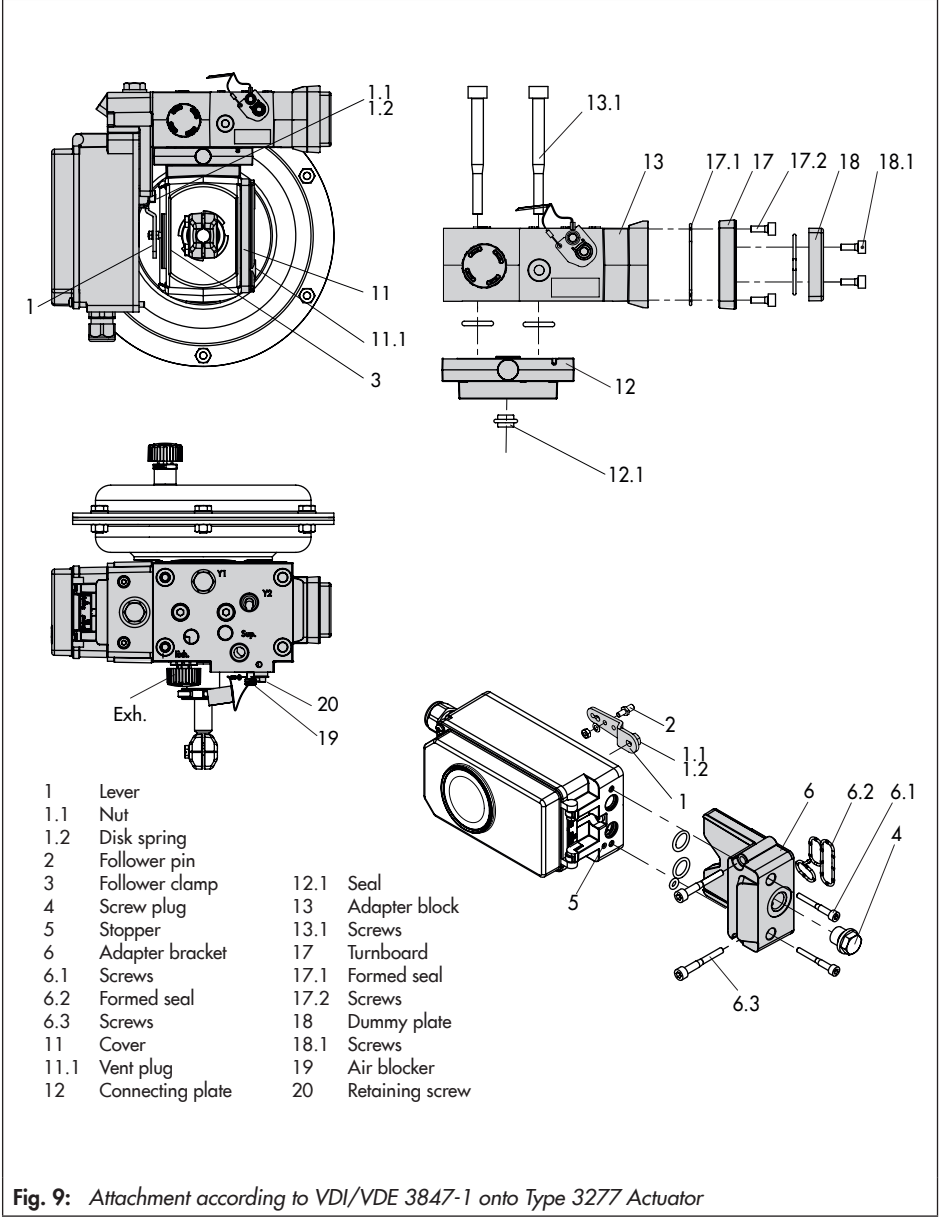
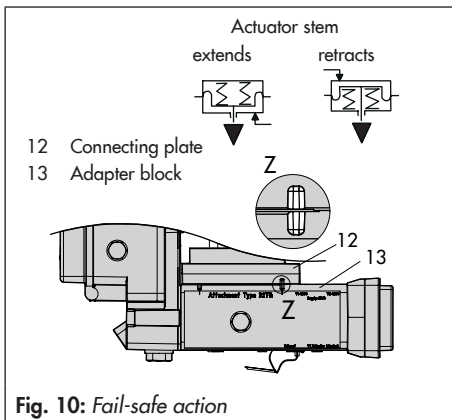


Fig. 9: Attachment according to VDI/VDE 3847-1 onto Type 3277 Actuator

## Mounting and start-up

7. Insert the screws (13.1) through the middle holes of the adapter block (13).
8. Place the connecting plate (12) together with the seal (12.1) onto the screws (13.1) corresponding to the fail-safe action "actuator stem extends" or "actuator stem retracts". The fail-safe action that applies is determined by aligning the groove of the adapter block (13) with the groove of the connecting plate (12) (Fig. 10).



9. Mount the adapter block (13) together with the connecting plate (12) to the actuator using the screws (13.1).
10. Insert the vent plug (11.1) into the **Exh.** connection.
11. For fail-safe action "actuator stem extends", seal the Y1 port with a blanking plug.  
For fail-safe action "actuator stem retracts", connect the Y1 port to the signal pressure connection of the actuator.

Place positioner on the adapter block (13) in such a manner that the follower pin (2) rests on the top of the follower clamp (3). Adjust the lever (1) correspondingly and open the positioner cover to hold the positioner shaft in position at the cap or rotary pushbutton.

The lever (1) must rest on the follower clamp with spring force.

Fasten the positioner to the adapter block (13) using the two fastening screws (6.3). Make sure the formed seal (6.2) is properly seated.

12. Mount cover (11) on the other side to the yoke. Make sure that the vent plug is located at the bottom when the control valve is installed to allow any condensed water that collects to drain off.

**Attachment to NAMUR rib (see Fig. 11)**

- Required mounting parts and accessories: Table 5 on page 25.
- Observe travel tables on page 28.

1. **Series 240 Valves, actuator size up to 1400-60 cm<sup>2</sup>:** Screw the two bolts (14) to the bracket of the stem connector or directly to the stem connector (depending on the version), place the follower plate (3) on top and use the screws (14.1) to fasten it.

**Type 3251 Valve, 350 to 2800 cm<sup>2</sup>:** Screw the longer follower plate (3.1) to the bracket of the stem connector or directly to the stem connector (depending on the version).

**Type 3254 Valve, 1400-120 to 2800 cm<sup>2</sup>:** Screw the two bolts (14) to the bracket (16). Fasten the bracket (16) onto the stem connector, place the follower plate (3) on top and use the screws (14.1) to fasten it.

Mount the positioner on the NAMUR rib as shown in Fig. 11.

2. For **attachment to the NAMUR rib**, fasten the NAMUR connection block (10) directly into the existing yoke bore using the screw and toothed lock washer (11). Align the marking on the NAMUR valve connection (on the side marked '1') to 50 % travel.
- For attachment to **valves with rod-type yokes** using the formed plate (15), which

is placed around the yoke: screw the four studs into the NAMUR connection block (10). Place the NAMUR connection block on the rod and position the formed plate (15) on the opposite side. Use the nuts and toothed lock washers to fasten the formed plate onto the studs. Align the marking on the NAMUR valve connection (on the side marked '1') to 50 % travel.

3. Place the adapter bracket (6) on the positioner and mount using the screws (6.1). Make sure that the seals are correctly seated. For positioners **with air purging**, remove the stopper (5) before mounting the positioner. For positioners **without air purging**, replace the screw plug (4) with a vent plug.
4. Select required lever size (1) **M**, **L** or **XL** and pin position according to the actuator size and valve travel listed in the travel table on page 28.

Should a pin position other than position 35 with the standard M lever be required or an L or XL lever size be required, proceed as follows:

- Fasten the follower pin (2) in the assigned lever hole (pin position as specified in the travel table). Only use the longer follower pin (2) included in the mounting kit.
- Place the lever (1) on the shaft of the positioner and fasten it tight using the disk spring (1.2) and nut (1.1). Move lever

## Mounting and start-up

once all the way as far as it will go in both directions.

5. Insert the formed seal (6.2) in the groove of the adapter bracket.
6. Insert the formed seal (17.1) into the turnboard (17) and mount the turnboard to the adapter block (13) using the screws (17.2).
7. Mount the blank plate (18) to the turnboard using the screws (18.1). Make sure that the seals are correctly seated.

---

### **i** Note

*A solenoid valve can also be mounted in place of the blank plate (18). The orientation of the turnboard (17) determines the mounting position of the solenoid valve. Alternatively, a restrictor plate can be mounted (▶ AB 11).*

---

8. Fasten the adapter block (13) to the NAMUR connection block using the screws (13.1).
9. Insert the vent plug into the Exh. connection.
10. Place the positioner on the adapter block (13) in such a manner that the follower pin (2) rests on the top of the follower plate (3, 3.1). Adjust the lever (1) correspondingly.  
Fasten the positioner to the adapter block (13) using the two fastening screws (6.3). Make sure the formed seal (6.2) is properly seated.
11. For **single-acting actuators without air purging**, connect the Y1 port of the

adapter block to the signal pressure connection of the actuator. Seal the Y2 port with a blanking plug.

For **double-acting actuators and actuators with air purging**, connect the Y2 port of the adapter block to the signal pressure connection of the second actuator chamber or spring chamber of the actuator.

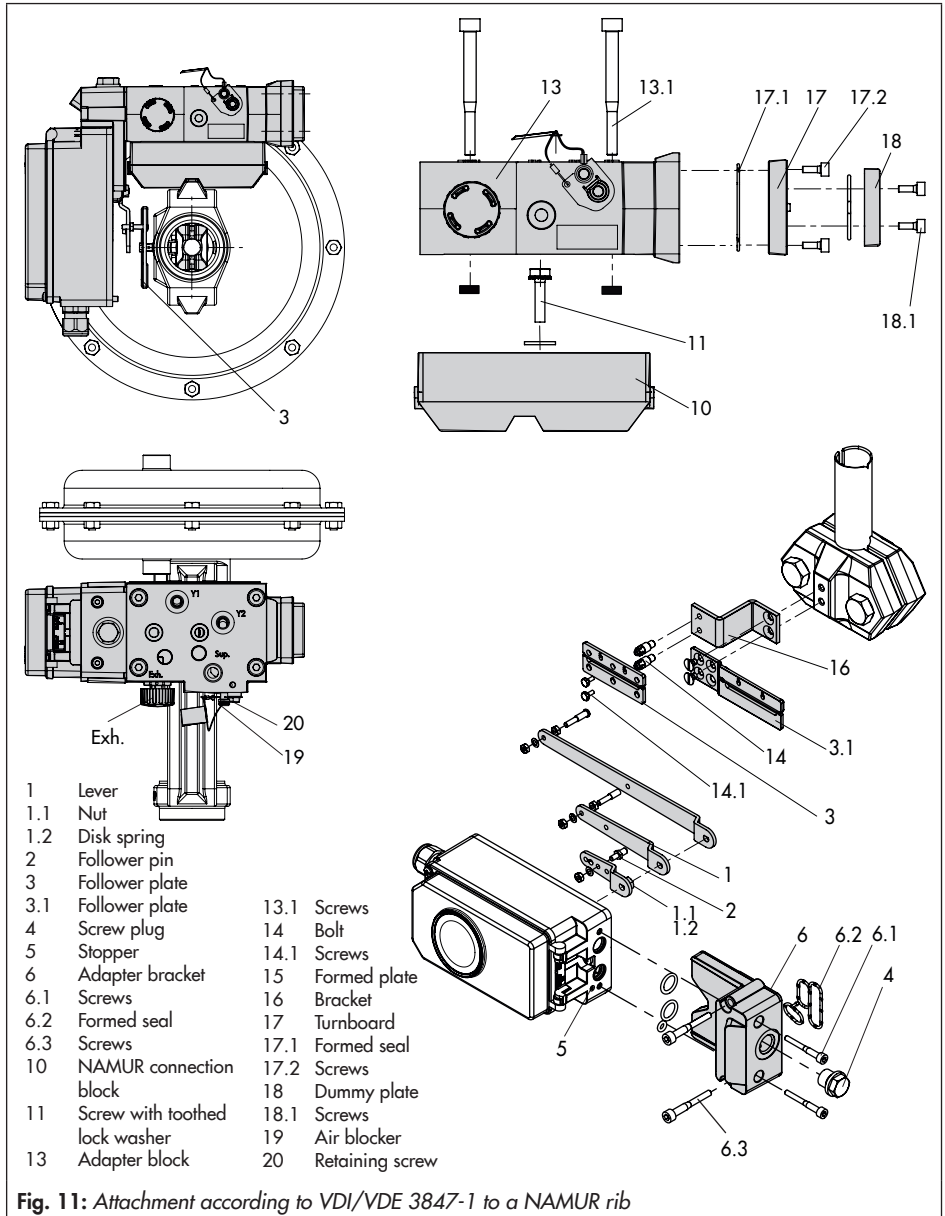
## 5.6 Attachment according to VDI/VDE 3847-2

Attachment according to VDI/VDE 3847-2 for PFEIFFER SRP (single-acting) and DAP (double-acting) rotary actuators in sizes 60 to 1200 with NAMUR interface and air purging of the actuator's spring chamber allows the direct attachment of the positioner without additional piping.

Additionally, the positioner can be replaced quickly while the process is running by blocking the air in single-acting actuators.

### **Procedure to block the actuator in place (see Fig. 12):**

1. Unscrew the red retaining screw (1).
2. Turn the air blocker (2) on the bottom of the adapter block according to the inscription.



### 5.6.1 Version for single-acting actuator

#### Mounting onto a PFEIFFER Type 31a (edition 2020+) SRP Rotary Actuator

→ Refer to Fig. 14.

1. Fasten the adapter block (1) to the actuator's NAMUR interface using the four fastening screws (2).

→ Make sure that the seals are correctly seated.

2. Mount the follower wheel (3) onto the actuator shaft. Use the matching shaft adapter (see Table 6 on page 26).

3. Place the adapter bracket (4) onto the adapter block (1) and fasten it using the fastening screws (5).

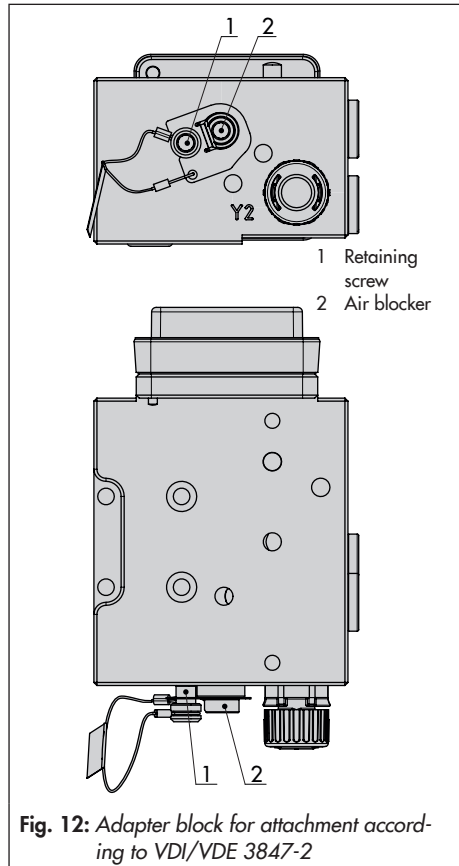
→ Make sure that the seals are correctly seated.

4. Insert and fasten the follower pin in the 90° position on the positioner's lever (see Fig. 13). Only use the longer follower pin included in the mounting kit.

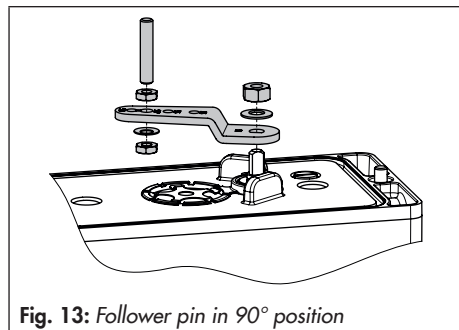
5. Align the positioner on the adapter bracket (1) in such a way that the follower pin engages into the actuator's follower wheel (3).

6. Fasten the positioner onto the adapter bracket (4) using the fastening screws (6).

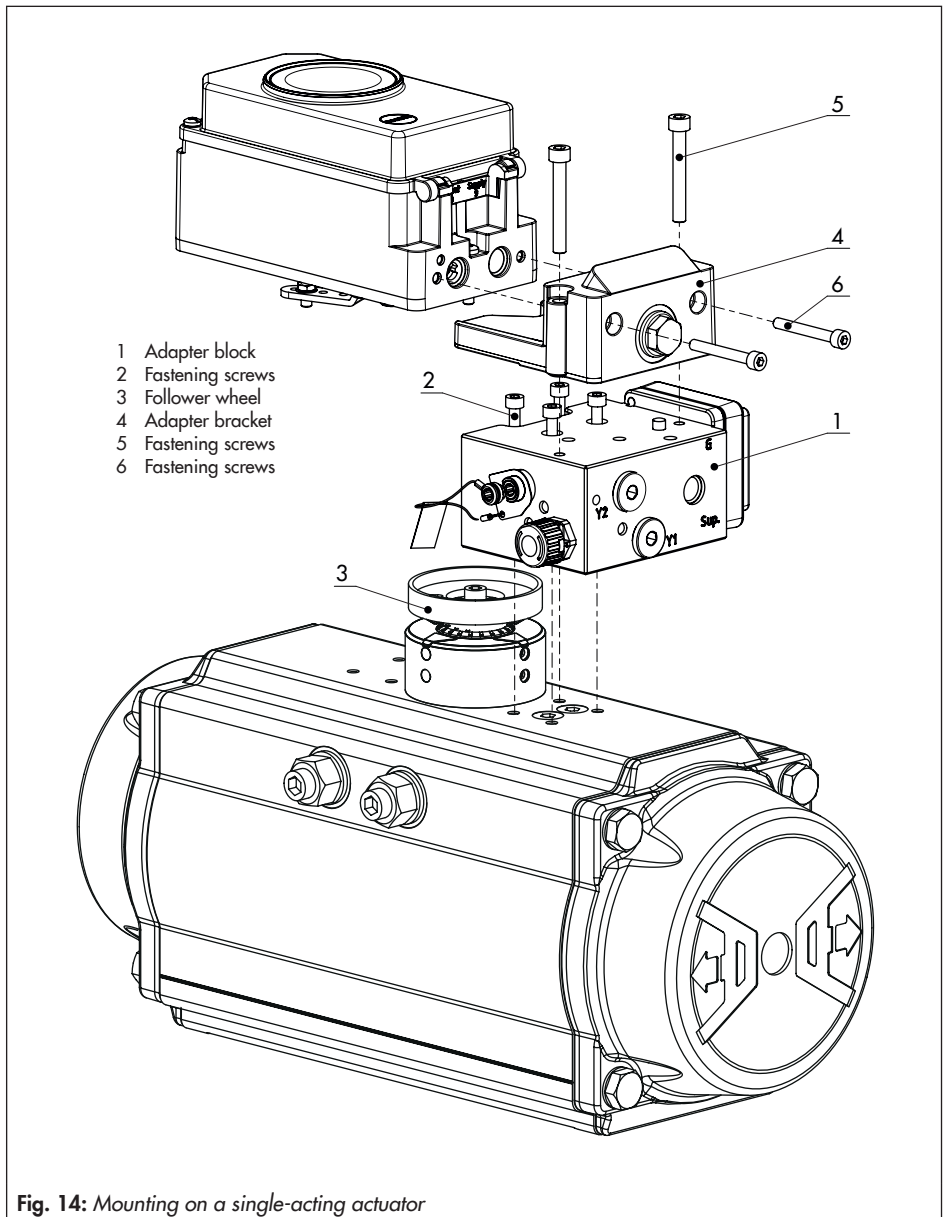
→ Make sure that the seals are correctly seated.



**Fig. 12:** Adapter block for attachment according to VDI/VDE 3847-2



**Fig. 13:** Follower pin in 90° position



### 5.6.2 Version for double-acting actuator

A reversing amplifier must be additionally mounted for applications with double-acting (DAP) actuators or applications with single-acting (SAP) actuators that include partial stroke testing.

In this case, a special adapter bracket (4) is required for mounting.

→ Refer to Fig. 16.

1. Fasten the adapter block (1) to the actuator's NAMUR interface using the four fastening screws (2).

→ Make sure that the seals are correctly seated.

2. Mount the follower wheel (3) onto the actuator shaft. Use the matching adapter (see Table 6 on page 26).

3. Place the adapter bracket (4) onto the adapter block (1) and fasten it using the fastening screws (5).

→ Make sure that the seals are correctly seated.

4. Insert and fasten the follower pin into the 90° position on the positioner's lever (see Fig. 13 on page 58).

5. Align the positioner on the adapter bracket (1) in such a way that the follower pin engages into the actuator's follower wheel (3).

6. Fasten the positioner onto the adapter bracket (4) using the fastening screws (6).

7. Mount the Type 3710 Reversing Amplifier (7) together with the two guide bush-

ings (8) and terminal plate (9) onto the adapter bracket using the associated fastening screws (10).

→ Make sure that the seals are correctly seated.

8. Remove the vent plug at the adapter block and seal the opening with the G 1/4 screw plug.

9. Mount the turnboard marked '**Doppel**' for double-acting actuators or the turnboard marked '**PST**' for single-acting actuators with partial stroke testing. See Fig. 15.

→ Make sure that the seals are correctly seated.

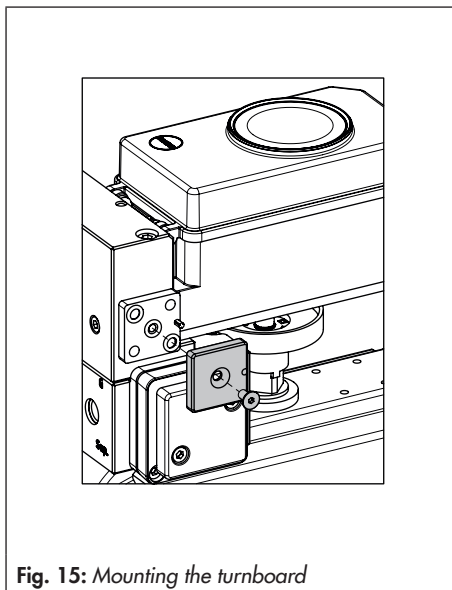
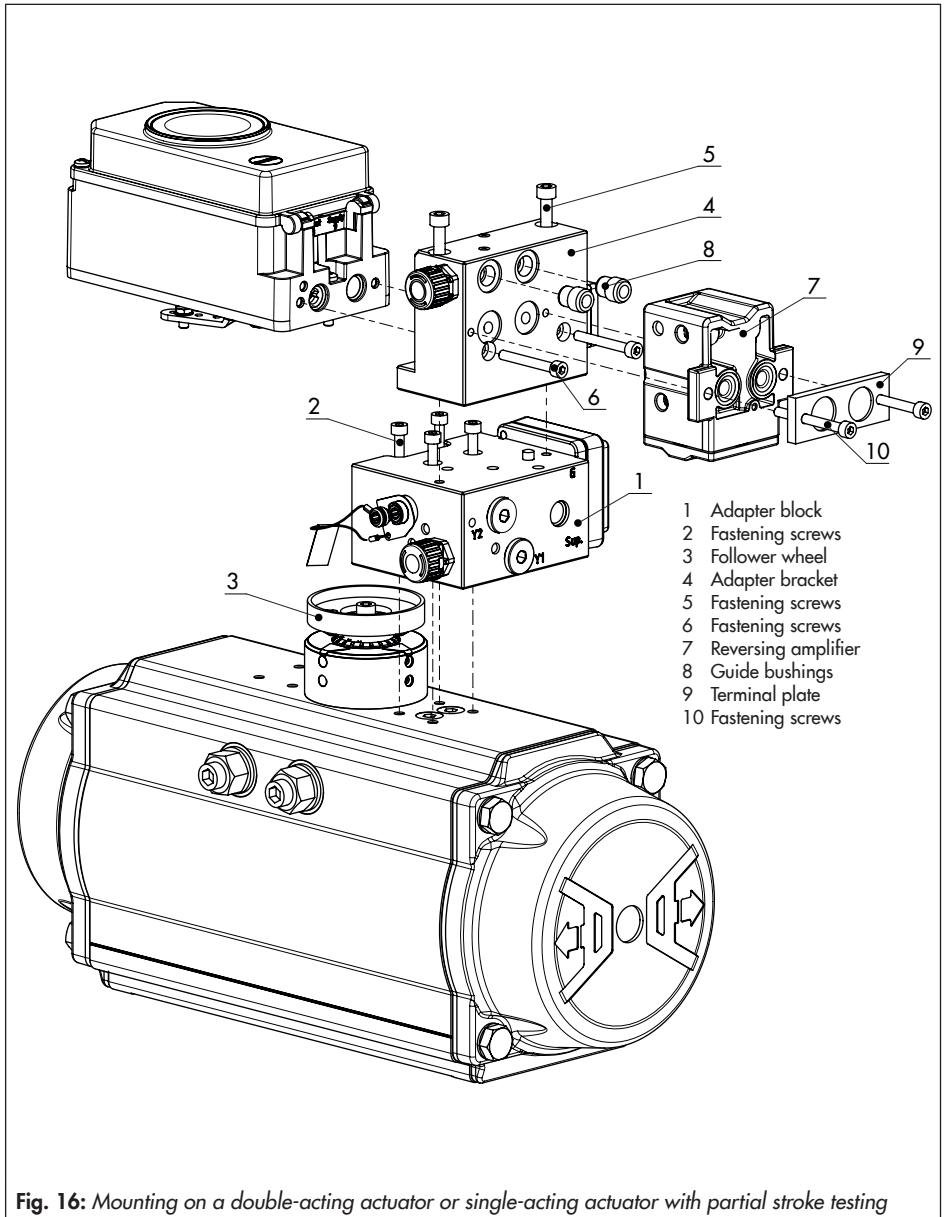


Fig. 15: Mounting the turnboard





## Mounting and start-up

### Intermediate plate for AA4 interface

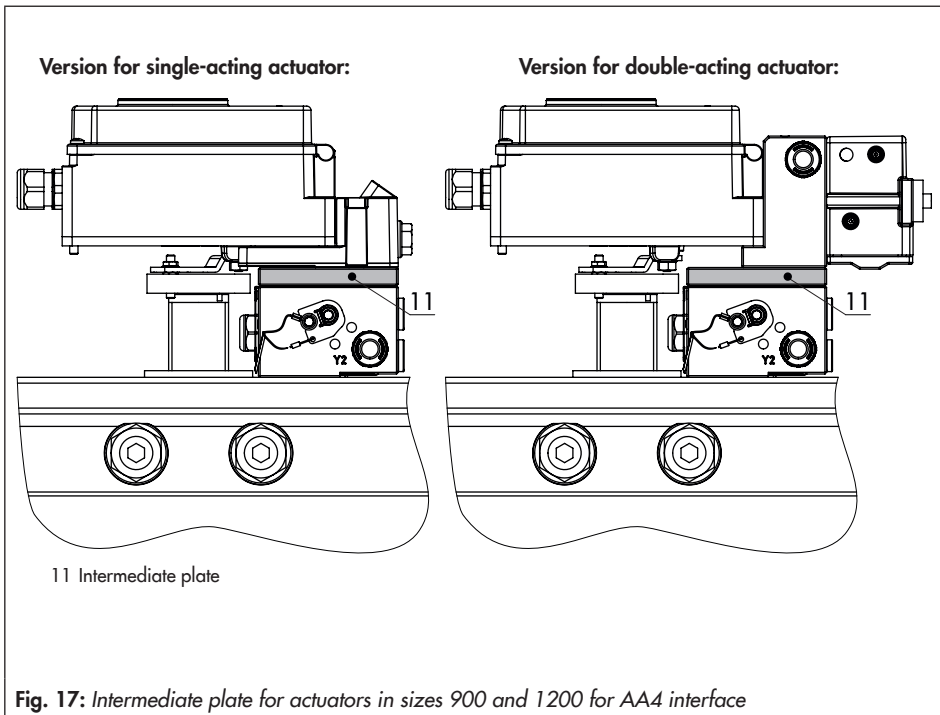
→ Refer to Fig. 17.

An intermediate plate (11) must be mounted between the adapter block and adapter bracket for PFEIFFER SRP and DAP rotary actuators in sizes 900 and 1200 with AA4 interface. This plate is included in the accessories for the shaft adapter AA4 (see Table 6 on page 26).

### Mounting a solenoid valve

→ Refer to Fig. 18.

A solenoid valve can also be mounted in place of the blank plate (18). The orientation of the turnboard (17) determines the mounting position of the solenoid valve. Alternatively, a restrictor plate can be mounted. Further information can be found in the document ► AB 11 (Accessories for Solenoid Valves).



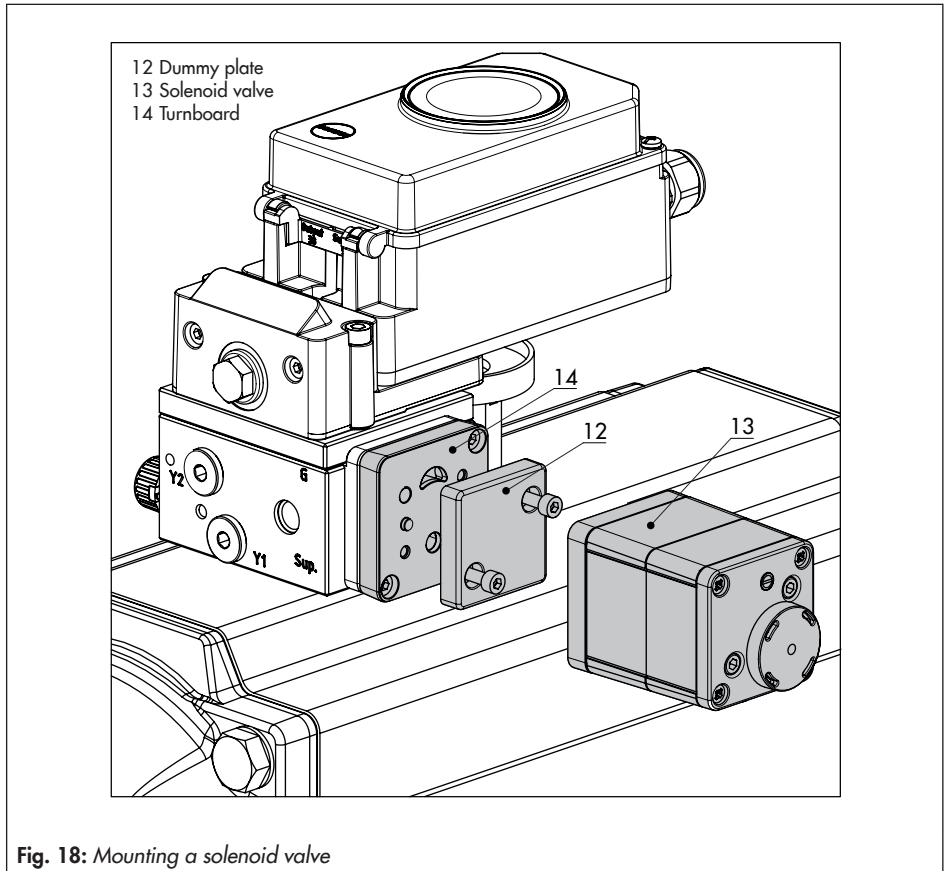


Fig. 18: Mounting a solenoid valve

### 5.7 Attachment to Type 3510 Micro-flow Valve

→ Refer to Fig. 19

→ Required mounting parts and accessories: Table 4 on page 25.

→ Observe travel tables on page 28.

The positioner is attached to the valve yoke using a bracket.

1. Fasten the bracket (9.1) to the stem connector.
2. Screw the two bolts (9.2) to the bracket (9.1) of the stem connector (9), place the follower plate (3) on top and use the screws (9.3) for fastening.
3. Mount the travel indication scale (accessories) to the outer side of the yoke using the hex screws (12.1), ensuring that the scale is aligned with the stem connector.
4. Fasten the hex bar (11) onto the outer side of yoke by screwing the M8 screws (11.1) directly into the holes on the yoke.
5. Fasten the bracket (10) to the hex bar using the hex screw (10.1), washer and tooth lock washer.
6. Mount connecting plate (6) or pressure gauge bracket (7) with pressure gauges on the positioner, making sure the two seals are seated properly.
7. Unscrew the standard M lever (1) including follower pin (2) from the positioner shaft.
8. Take the S lever (1) and screw the follower pin (2) in the hole for pin position 17.

9. Place the S lever on the positioner shaft and screw tight using the disk spring (1.2) and nut (1.1).

Move lever once all the way as far as it will go in both directions.

10. Place positioner on the bracket (10) in such a manner that the follower pin slides into the groove of the follower pin (3). Adjust the lever (1) correspondingly. Screw the positioner to the bracket (10) using both its screws.

### 5.8 Attachment to rotary actuators

→ Refer to Fig. 21

→ Required mounting parts and accessories: Table 7 on page 26.

→ Observe travel tables on page 28.

The positioner is mounted to the rotary actuator using two pairs of brackets.

Prior to attaching the positioner to the SAMSON Type 3278 Rotary Actuator, mount the associated adapter (5) to the free end of the rotary actuator shaft.

---

#### **i Note**

*On attaching the positioner as described below, it is imperative that the actuator's direction of rotation is observed.*

---

1. Place follower clamp (3) on the slotted actuator shaft or adapter (5).

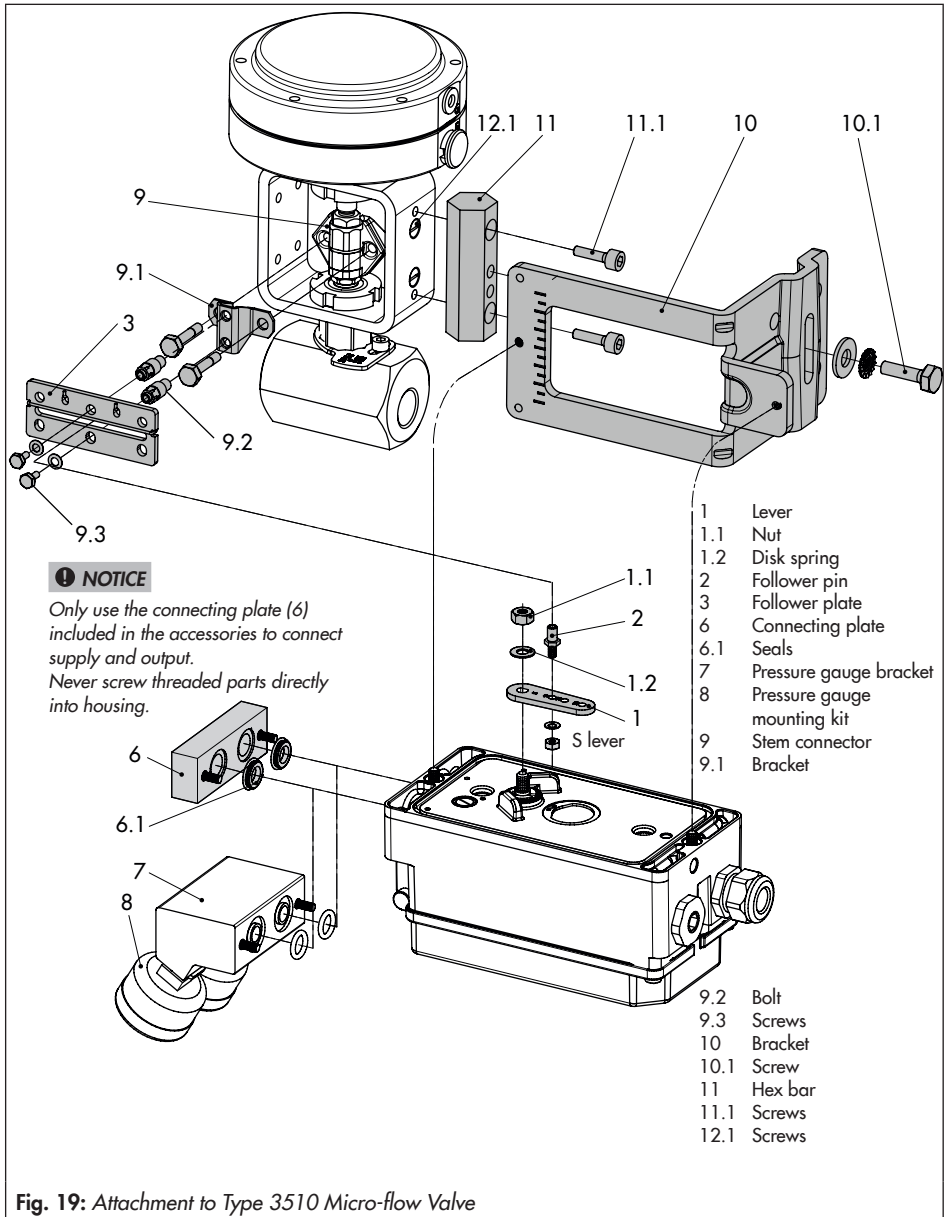
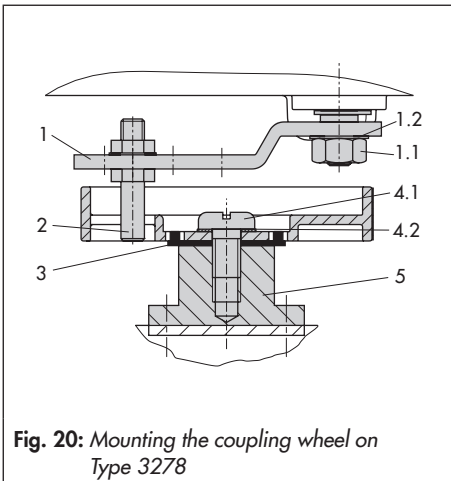


Fig. 19: Attachment to Type 3510 Micro-flow Valve

## Mounting and start-up

2. Place coupling wheel (4) with flat side facing the actuator on the follower clamp (3). Refer to Fig. 22 to align slot so that it matches the direction of rotation when the valve is in its closed position.
3. Fasten the coupling wheel (4) and follower clamp (3) tightly onto the actuator shaft using screw (4.1) and disk spring (4.2).
4. Fasten the bottom pair of brackets (10.1) with the bends pointing either facing to the inside or to the outside (depending on the actuator size) onto the actuator housing. Position the top pair of brackets (10) and fasten.
5. Mount connecting plate (6) or pressure gauge bracket (7) with pressure gauges on the positioner, making sure the two seals are seated properly. Double-acting springless rotary actuators require the use of a reversing amplifier on the connection side of the positioner housing (see section 5.9).
6. Unscrew the standard follower pin (2) from the positioner's **M** lever (1). Use the metal follower pin ( $\varnothing$  5 mm) included in the mounting kit and screw tight into the hole for pin position **90°**.
7. Place positioner on the top bracket (10) and fasten tight. Taking the actuator's direction of rotation into account, adjust lever (1) so that it engages in the slot of the coupling wheel (4) with its follower pin (Fig. 22). It must be guaranteed that the lever (1) is parallel to the long side of the positioner when the actuator is at half its angle of rotation.
8. Stick the scale plate (4.3) on the coupling wheel so that the arrow tip indicates the closed position and it can be easily read when the valve is installed.



### 5.8.1 Heavy-duty version

→ Refer to Fig. 23

→ Required mounting parts and accessories: Table 7 on page 26.

Both mounting kits contain all the necessary mounting parts. The parts for the actuator size used must be selected from the mounting kit.

Prepare actuator and mount possibly required adapter supplied by the actuator manufacturer.

1. Mount the housing (10) onto the rotary actuator. In case of VDI/VDE attachment,

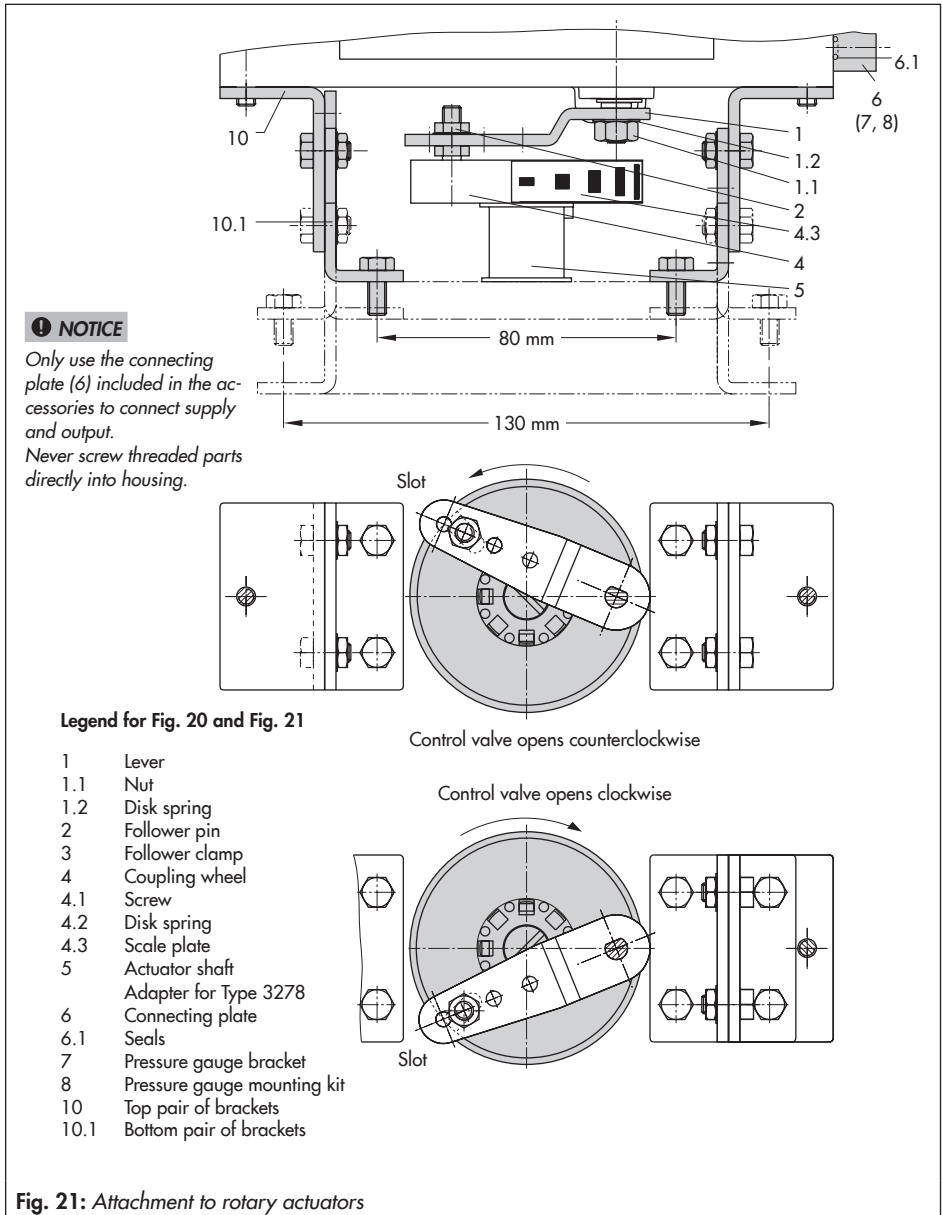


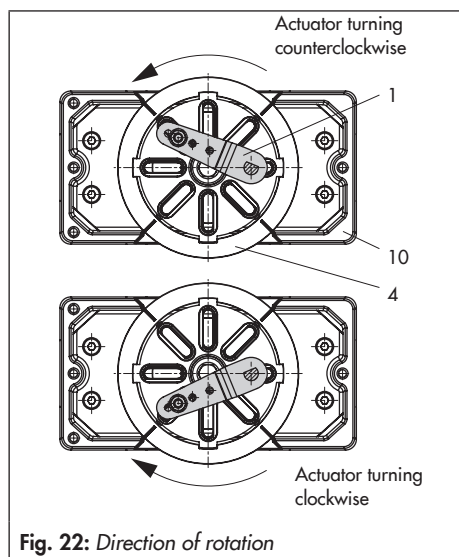
Fig. 21: Attachment to rotary actuators

## Mounting and start-up

place spacers (11) underneath, if necessary.

- For **SAMSON** Type 3278 and **VETEC S160 Rotary Actuators**, fasten the adapter (5) onto the free end of the shaft and for **VETEC R Actuator**, place on the adapter (5.1). For **Type 3278, VETEC S160** and **VETEC R Actuators**, place on the adapter (3), for **VDI/VDE version**, only use the adapter when it is required due to the actuator size.
- Stick adhesive label (4.3) onto the coupling in such a manner that the yellow part of the sticker is visible in the window of the housing when the valve is OPEN. Adhesive labels with explanatory symbols are enclosed and can be stuck on the enclosure, if required.

- Fasten coupling wheel (4) on the slotted actuator shaft or adapter (3) using screw (4.1) and disk spring (4.2).
- Unscrew the standard follower pin (2) from the positioner's M lever (1). Attach the follower pin ( $\varnothing 5$  mm) included in the mounting kit to pin position  $90^\circ$ .
- Mount connecting plate (6) for required  $G \frac{1}{4}$  connecting thread or pressure gauge bracket (7) with pressure gauges on the positioner, making sure the two seals (6.1) are seated properly. Double-acting springless rotary actuators require the use of a reversing amplifier on the connection side of the positioner housing (see section 5.9).
- For actuators with a volume of less than  $300 \text{ cm}^3$ , screw the screw restriction (order no. 1400-6964) into the signal pressure output of the positioner (or the output of the pressure gauge bracket or connecting plate).
- Place positioner on housing (10) and screw it tight. Taking the actuator's direction of rotation into account, adjust lever (1) so that it engages in the correct slot with its follower pin (Fig. 22).





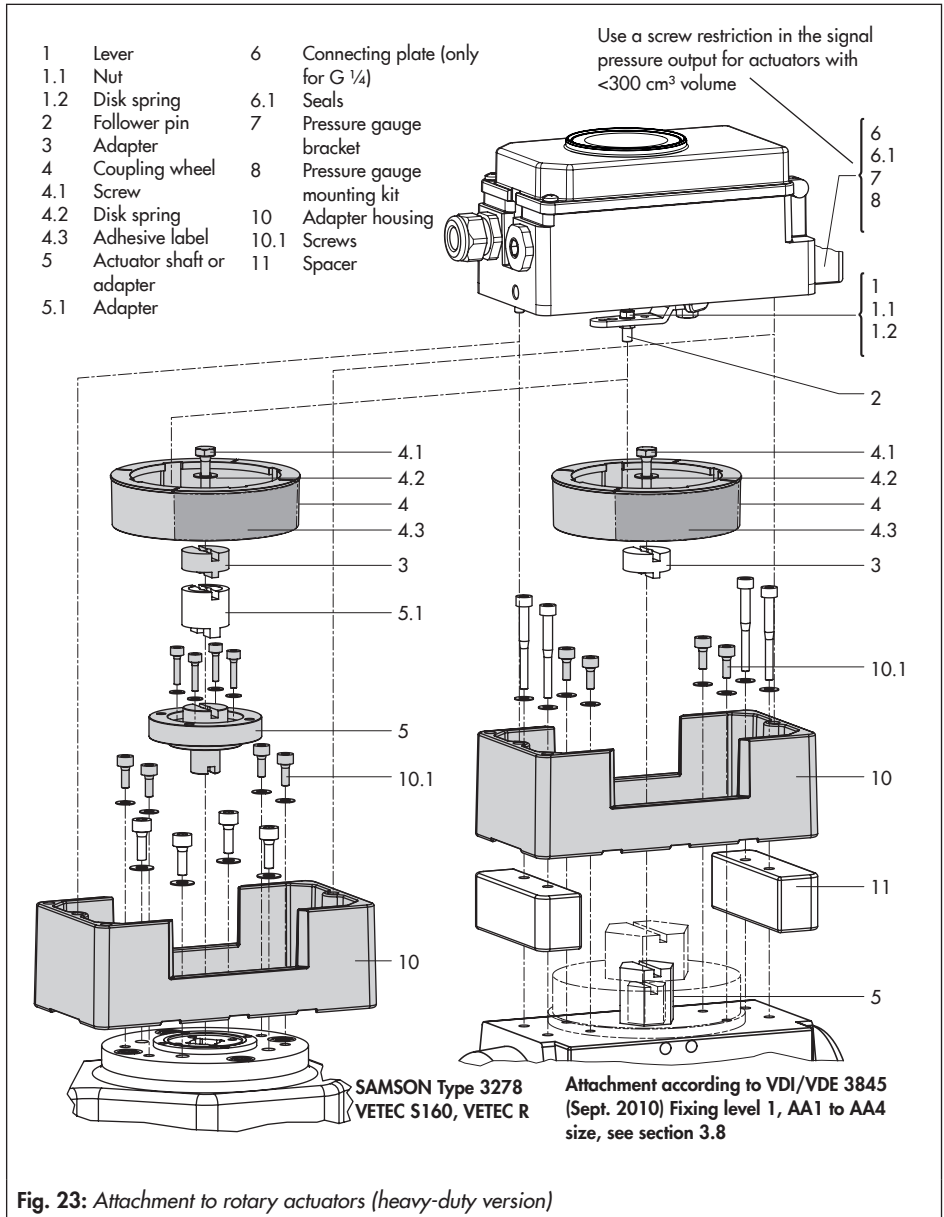


Fig. 23: Attachment to rotary actuators (heavy-duty version)

### 5.9 Reversing amplifier for double-acting actuators

For the use with double-acting actuators, the positioner must be fitted with a reversing amplifier:

- SAMSON Type 3710 Reversing Amplifier, ► EB 8392
- If a different reversing amplifier (item no. 1079-1118 or 1079-1119) is used, mount it as described in section 5.9.1.

#### The following applies to all reversing amplifiers:

The signal pressure of the positioner is supplied at the output 1 of the reversing amplifier. An opposing pressure, which equals the required supply pressure (Z) when added to the pressure at output 1, is applied at output 2.

The following relationship applies:

**output 1 + output 2 = Supply pressure (Z).**

Connect output 1 to the signal pressure connection on the actuator that causes the valve to open when the pressure rises.

Connect output 2 to the signal pressure connection on the actuator that causes the valve to close when the pressure rises.

- Set slide switch on positioner to AIR TO OPEN.

---

#### **i** Note

How the outputs are marked depends on the reversing amplifier used:

- **Type 3710:** Output 1/2 =  $Y_1/Y_2$
  - **1079-1118 and 1079-1119:**  
Output 1/2 =  $A_1/A_2$
- 

### 5.9.1 Reversing amplifier (1079-1118 or 1079-1119)

→ Refer to Fig. 24

1. Mount the connecting plate (6) from the accessories in Table 6 to the positioner. Make sure that both O-rings (6.1) are seated correctly.
2. Thread the special nuts (1.3) from the accessories of the reversing amplifier into the boreholes of the connecting plate.
3. Insert the gasket (1.2) into the recess of the reversing amplifier and slide both the hollowed special screws (1.1) into the connecting boreholes **A<sub>1</sub>** and **Z**.
4. Place the reversing amplifier onto the connecting plate (6) and screw tight using both the special screws (1.1).
5. Use a screwdriver (8 mm wide) to screw the enclosed filters (1.6) into the connection boreholes **A<sub>1</sub>** and **Z**.

---

#### **!** NOTICE

*Air can escape uncontrolled from the signal pressure connection.*

*Do not unscrew the sealing plug (1.5) out of the reversing amplifier.*

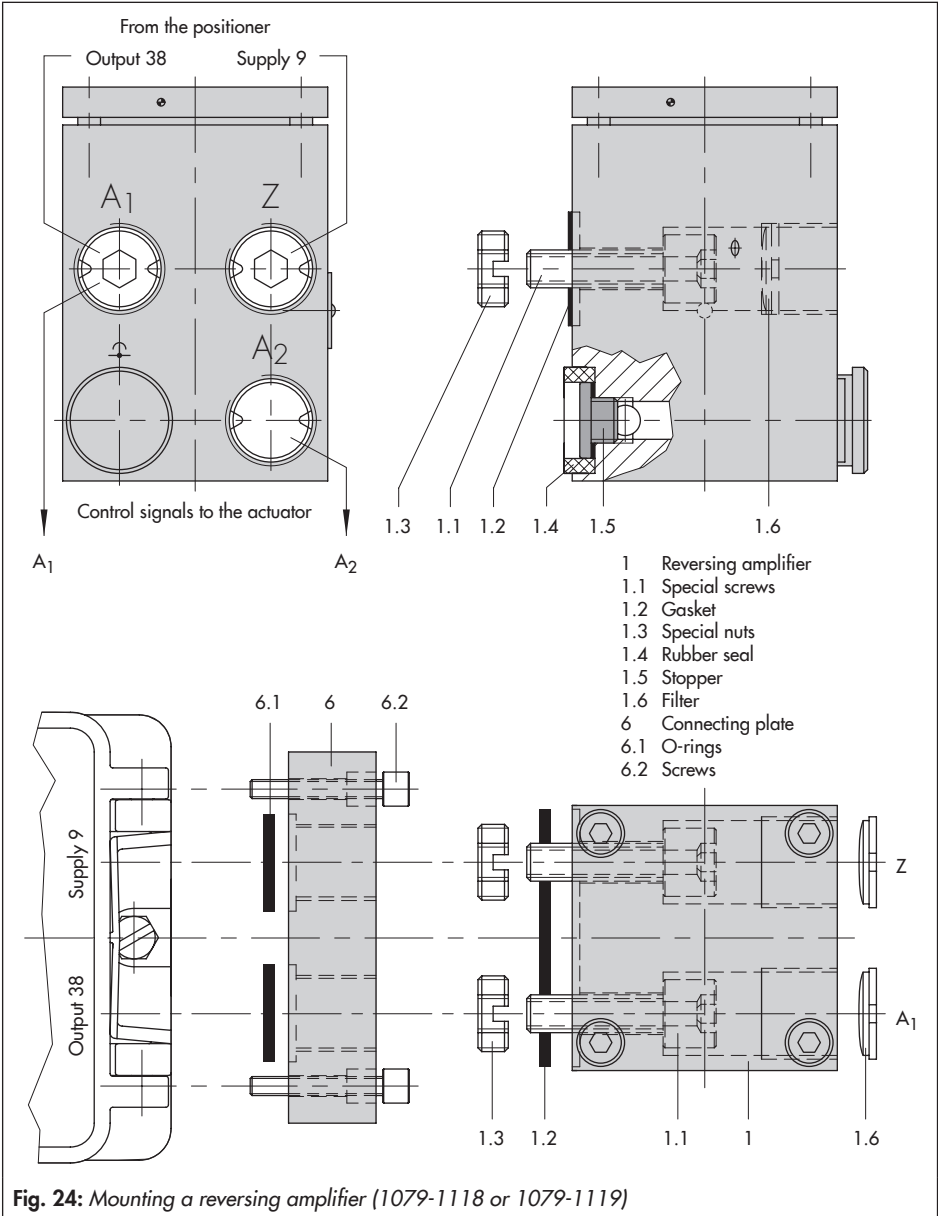
---

#### **i** Note

*The rubber seal (1.4) is not required and can be removed when the sealing plug is used.*

---

6. After initialization, set Code 16 (Pressure limit) to No.



## Mounting and start-up

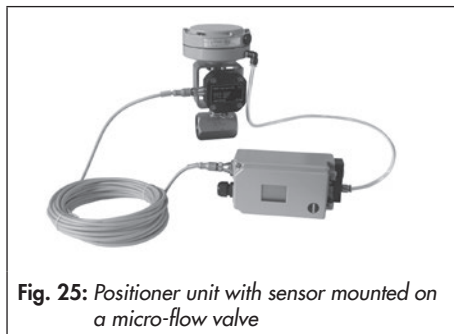
### Pressure gauge attachment

The mounting sequence shown in Fig. 24 remains unchanged. Screw a pressure gauge bracket onto the connections **A<sub>1</sub>** and **Z**.

Pressure gauge	G ¼	1400-7106
bracket	¼ NPT	1400-7107

Pressure gauges for supply air Z and output A<sub>1</sub> as listed in Table 8 to Table 9.

## 5.10 Attachment of external position sensor



**Fig. 25:** Positioner unit with sensor mounted on a micro-flow valve

→ Required mounting parts and accessories: Table 8 on page 27.

In the positioner version with an external position sensor, the sensor located in a separate housing is attached over a plate or bracket to the control valve. The travel pick-off corresponds to that of a standard device. The positioner can be mounted as required to a wall or a pipe.

**For the pneumatic connection** either a connecting plate (6) or a pressure gauge bracket (7) must be fixed to the housing, depending on the accessory chosen. Make sure the seals (6.1) are correctly inserted (see Fig. 9, bottom right).

**For the electrical connection** a 10 meter connecting lead with M12x1 connectors is included in the scope of delivery.

**i Note**

- In addition, the instructions in sections 5.15 and 5.16 apply for the pneumatic and electrical connection.
- Since 2009, the back of the position sensor (20) is fitted with two pins acting as mechanical stops for the lever (1). If this position sensor is mounted using old mounting parts, two corresponding  $\varnothing 8$  mm holes must be drilled into the mounting plate/bracket (21). A template is available for this purpose. See Table 8.

### 5.10.1 Mounting the position sensor with direct attachment

#### Type 3277-5 Actuator with 120 cm<sup>2</sup> (Fig. 6)

The signal pressure from the positioner is routed over the signal pressure connection of the connecting plate (9, Fig. 27 left) to the actuator diaphragm chamber. To proceed, first screw the connecting plate (9) included in the accessories onto the actuator yoke.

- Turn the connecting plate (9) so that the correct symbol for the fail-safe action "actuator stem extends" or "actuator stem retracts" is aligned with the marking (Fig. 27, below).
- Make absolutely sure that the gasket for the connecting plate (9) is correctly inserted.
- The connecting plate has threaded holes with NPT and G threads. Seal the threaded connection that is not used with the rubber seal and square plug.

#### Type 3277 Actuator with 175 to 750 cm<sup>2</sup>:

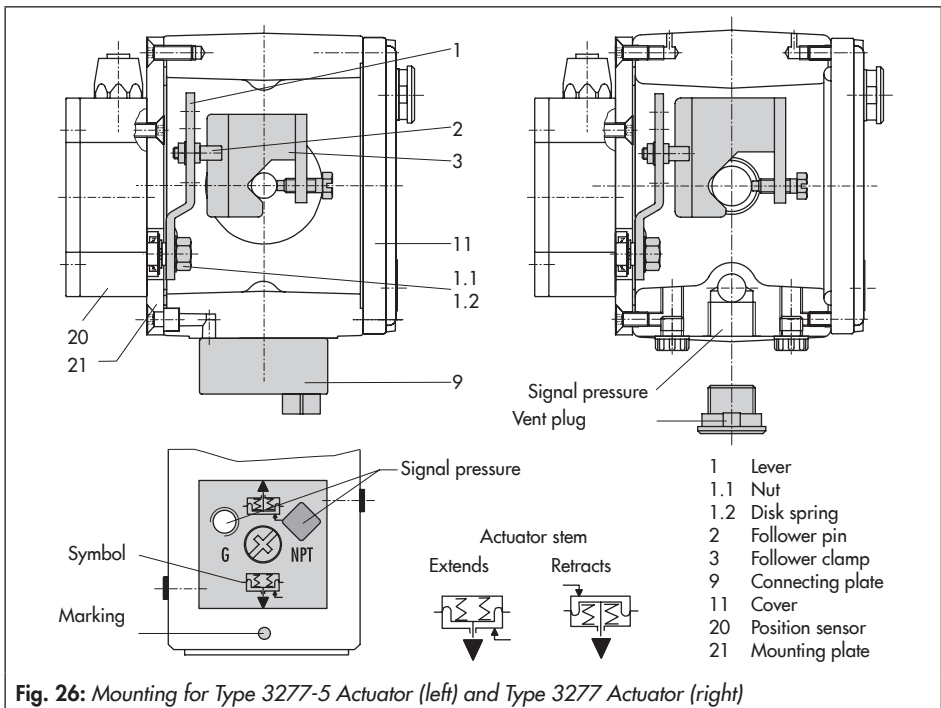
The signal pressure is routed to the connection at the side of the actuator yoke for the version with fail-safe action "actuator stem extends". For the fail-safe action "actuator stem retracts" the connection on the top diaphragm case is used. The connection at the side of the yoke must be fitted with a venting plug (accessories).

#### Mounting the position sensor

1. Place the lever (1) on the sensor in mid-position and hold it in place. Unthread the nut (1.1) and remove the lever together with the disk spring (1.2) from the sensor shaft.
2. Screw the position sensor (20) onto the mounting plate (21).
3. Depending on the actuator size and rated valve travel, determine which lever and position of the follower pin (2) is to be used from the travel table on page 28. The positioner is delivered with the **M** lever in pin position **35** on the sensor. If necessary, remove the follower pin (2) from its pin position and move it to the hole for the recommended pin position and screw tight.
4. Place the lever (1) and disk spring (1.2) on the sensor shaft. Place the lever **in mid-position** and **hold it in place**. Screw on the nut (1.1).
5. Place follower clamp (3) on the actuator stem, align it and screw tight so that the mounting screw is located in the groove of the actuator stem.

## Mounting and start-up

6. Place the mounting plate together with the sensor onto the actuator yoke so that the follower pin (2) rests on the top of the follower clamp (3). It must rest on it with spring force. Fasten the mounting plate (21) onto the actuator yoke using both fixing screws.
7. Mount cover (11) on the other side. Make sure that the vent plug is located at the bottom when the control valve is installed to allow any condensed water that collects to drain off.



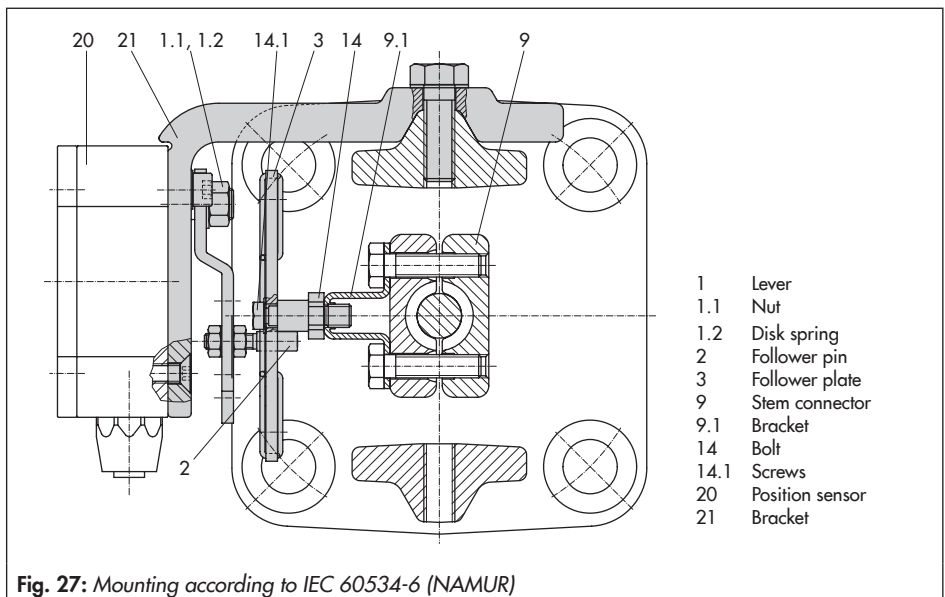
### 5.10.2 Mounting the position sensor with attachment according to IEC 60534-6

- Required mounting parts and accessories: Table 8 on page 27.
  - Refer to Fig. 27
1. Place the lever (1) on the position sensor in **mid-position** and **hold it in place**. Unthread the nut (1.1) and remove the lever together with the disk spring (1.2) from the sensor shaft.
  2. Screw the position sensor (20) onto the bracket (21).

The standard attached **M** lever with the follower pin (2) at position **35** is designed for

120 to 350 cm<sup>2</sup> actuators with 15 mm rated travel. For other actuator sizes or travels, select the lever and pin position from the travel table on section 3.5.1. L and XL levers are included in the mounting kit.

3. Place the lever (1) and disk spring (1.2) on the sensor shaft. Place the lever in **mid-position** and **hold it in place**. Screw on the nut (1.1).
4. Screw the two bolts (14) to the bracket (9.1) of the stem connector (9), place the follower plate (3) on top and use the screws (14.1) for fastening.
5. Place the bracket with the sensor at the NAMUR rib in such a manner that the follower pin (2) rests in the slot of the follower plate (3), then screw the bracket using its fixing screws onto the valve.



### 5.10.3 Mounting the position sensor to Type 3510 Micro-flow Valve

→ Required mounting parts and accessories: Table 8 on page 27.

→ Refer to Fig. 28

1. Place the lever (1) on the position sensor in **mid-position** and **hold it in place**. Unscrew the nut (1.1) and remove the standard attached **M** lever (1) together with the disk spring (1.2) from the sensor shaft.

2. Screw the position sensor (20) onto the bracket (21).
3. Select the **S** lever (1) from the accessories and screw the follower pin (2) into the hole for pin position **17**. Place the lever (1) and disk spring (1.2) on the sensor shaft. Place the lever in mid-position and hold it in place. Screw on the nut (1.1).
4. Place follower clamp (3) on the valve stem connector, align at a right angle and screw tight.
5. Position the bracket (21) with the position sensor on the valve yoke and screw tight, making sure the follower pin (2) slides into the groove of the follower clamp (3).

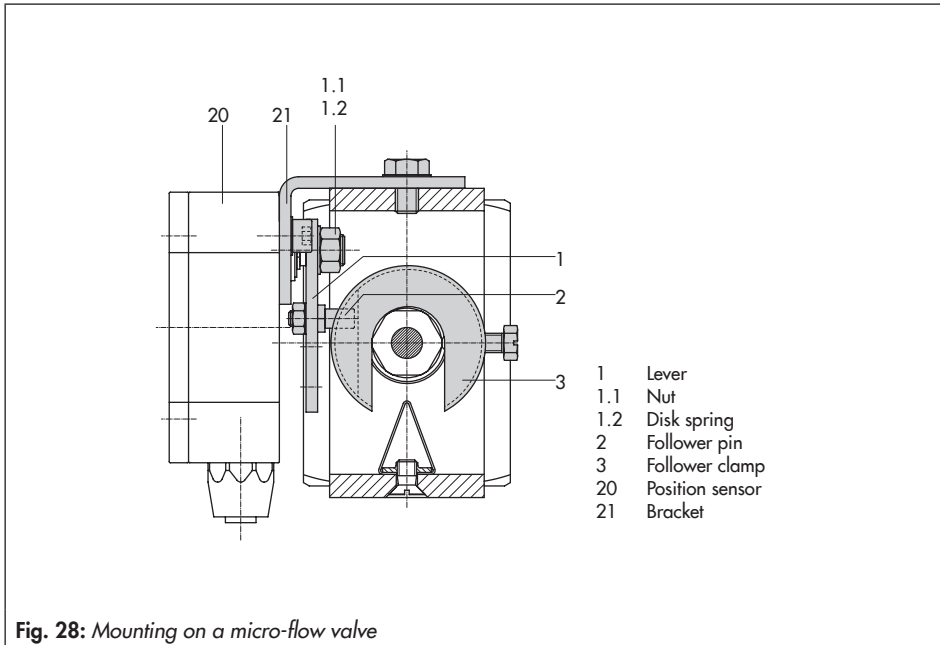


Fig. 28: Mounting on a micro-flow valve



### 5.10.4 Mounting on rotary actuators

→ Required mounting parts and accessories: Table 8 on page 27.

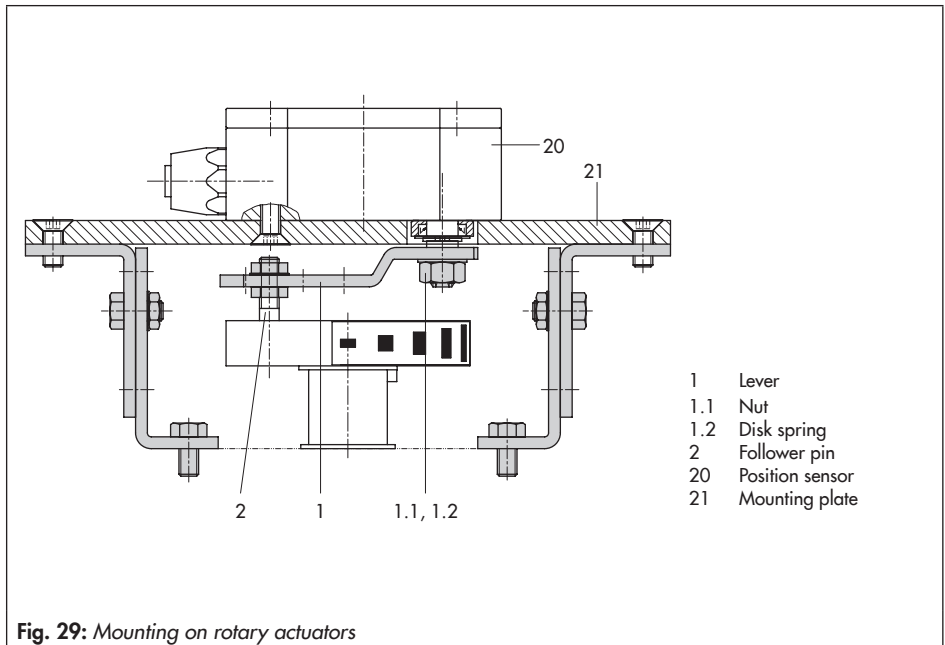
→ Refer to Fig. 29

1. Place the lever (1) on the position sensor in **mid-position** and **hold it in place**. Unthread the nut (1.1) and remove the lever together with the disk spring (1.2) from the sensor shaft.
2. Screw the position sensor (20) onto the mounting plate (21).

3. Replace the follower pin (2) normally attached to the lever (1) with the metal follower pin ( $\varnothing$  5 mm) from the accessories and screw it into the hole for pin position  $90^\circ$ .
4. Place the lever (1) and disk spring (1.2) on the sensor shaft. Place the lever **in mid-position** and **hold it in place**. Screw on the nut (1.1).

Follow the instructions describing attachment to the standard positioner in section 5.8.

Instead of the positioner, attach the position sensor (20) with its mounting plate (21).



### 5.11 Mounting the leakage sensor

→ Refer to Fig. 30

Normally, the control valve is delivered with positioner and leakage sensor already mounted.

If the leakage sensor is mounted after the valve has been installed or it is mounted onto another control valve, proceed as described in the following.

#### ! NOTICE

*Risk of malfunction due to incorrect fastening. Fasten the leakage sensor using a torque of  $20 \pm 5$  Nm.*

The M8 threaded connection on the NAMUR rib should preferably be used to mount the sensor (Fig. 30).

#### 💡 Tip

*If the positioner was mounted directly onto the actuator (integral attachment), the NAMUR interfaces on either side of the valve yoke can be used to mount the leakage sensor.*

The start-up of the leakage sensor is described in detail in the Operating Instructions for EXPERTplus Valve Diagnostics.

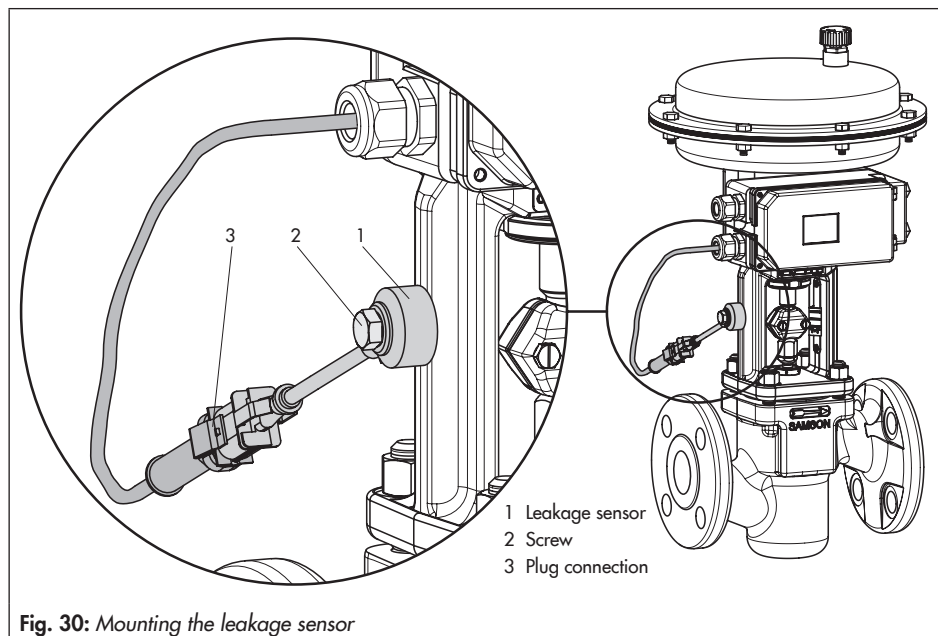


Fig. 30: Mounting the leakage sensor

## 5.12 Retrofitting an inductive limit switch

### Required retrofit kit:

Limit switch                      Order no. 1402-1770

#### **i** Note

The same requirements apply to retrofitting a unit as to servicing the positioner. For explosion-protected positioners, the requirements in Servicing explosion-protected devices need to be kept. Check the "Limit switch, inductive" box on the nameplate after installing the limit switch.

1. Take off the rotary pushbutton (3) and cap (1), unthread the five fastening screws (2) and lift off the plastic cover (9) together with the display, taking care not to damage the ribbon cable (between PCB and display).
2. Use a knife to cut an opening at the marked location (4).
3. Push the connector (11) with cable through the opening and secure the proximity switch (7) on the cover with a dot of glue.
4. Remove the jumper at the socket X7 of the top board and insert the cable connector (11).
5. Guide the cable in such a manner that the plastic cover can be placed back onto the positioner. Insert the fixing screws (2) and screw tight. Attach the clamping plate (8) onto the proximity switch.

6. Attach the rotary switch (5). Make sure the flattened side of the positioner shaft is turned so that the rotary switch (5) can be attached with the metal tag next to the proximity switch.
7. On start-up of the positioner, set the option inductive alarm under Code 38 from No to YES.

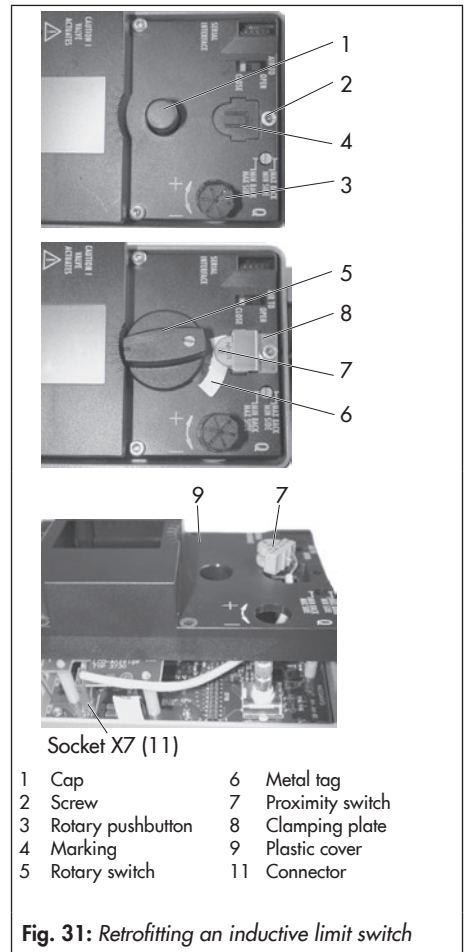


Fig. 31: Retrofitting an inductive limit switch

### 5.13 Attaching positioners with stainless steel housings

Positioners with stainless steel housings require mounting parts that are completely made of stainless steel or free of aluminum.

#### **i** Note

*The pneumatic connecting plate and pressure gauge bracket are available in stainless steel (order numbers listed below). The Type 3710 Pneumatic Reversing Amplifier is also available in stainless steel.*

Connecting plate (stainless steel)	G ¼ ¼ NPT	1400-7476 1400-7477
Pressure gauge bracket (stainless steel)	G ¼ ¼ NPT	1402-0265 1400-7108

Table 7 to Table 9 apply for attaching positioners with stainless steel housings with the following restrictions:

#### **Direct attachment**

All mounting kits from Table 2 and Table 3 can be used. The connection block is not required. The stainless steel version of the pneumatic connecting plate routes the air internally to the actuator.

#### **Attachment according to IEC 60534-6 (NAMUR rib or attachment to rod-type yokes)**

All mounting kits from Table 4 can be used. Connecting plate in stainless steel.

#### **Attachment to rotary actuators**

All mounting kits from Table 7 can be used except for the heavy-duty version. Connecting plate in stainless steel.

### 5.14 Air purging function for single-acting actuators

The instrument air leaving the positioner is diverted to the actuator spring chamber to provide corrosion protection inside the actuator. Observe the following:

#### **Direct attachment to Type 3277-5 (stem extends FA/stem retracts FE)**

The air purging function is automatically provided.

#### **Direct attachment to Type 3277, 175 to 750 cm<sup>2</sup>**

**FA:** Remove the stopper (12.2, Fig. 7) at the black connection block and make a pneumatic connection to the spring chamber on the vented side.

#### **! NOTICE**

*Mounting possibly incorrect when old powder-paint-coated aluminum connection blocks are used.*

*Mount old powder-paint-coated aluminum connection blocks as described in sections on Attachment according to IEC 60534-6 (NAMUR rib or attachment to rod-type yokes) and Attachment to rotary actuators.*

**FE:** The air purging function is automatically provided.

### Attachment according to IEC 60534-6 (NAMUR rib or attachment to rod-type yokes) and to rotary actuators

The positioner requires an additional port for the exhaust air that can be connected over piping. An adapter available as an accessory is used for this purpose:

Threaded bushing	G ¼	0310-2619
(M20x1.5)	¼ NPT	0310-2550

---

#### **i** Note

*The adapter uses one of the M20x1.5 connections in the housing which means **only one cable gland** can be installed.*

---

Should other valve accessories be used which vent the actuator (e.g. solenoid valve, volume booster, quick exhaust valve), this exhaust air must also be included in the purging function. The connection over the adapter at the positioner must be protected with a check valve (e.g. check valve G ¼, order no. 8502-0597) mounted in the piping. Otherwise the pressure in the positioner housing would rise above the ambient pressure and damage the positioner when the exhausting components respond suddenly.



## 5.15 Pneumatic connections

### **⚠ WARNING**

*Risk of injury by possible movement of exposed parts (positioner, actuator or valve) after connecting the signal pressure. Do not touch or block exposed moving parts.*

### **📌 NOTICE**

*Incorrect connection of the supply air will damage the positioner and will lead to malfunction.*

*Screw the screw fittings into the connecting plate, pressure gauge mounting block or connection block from the accessories.*

The pneumatic ports are located on the back of the positioner (see Fig. 32).

### **📌 NOTICE**

*Risk of malfunction due to failure to comply with required air quality.*

*Only use supply air that is dry and free of oil and dust.*

*Read the maintenance instructions for upstream pressure reducing stations.*

*Blow through all air pipes and hoses thoroughly before connecting them.*

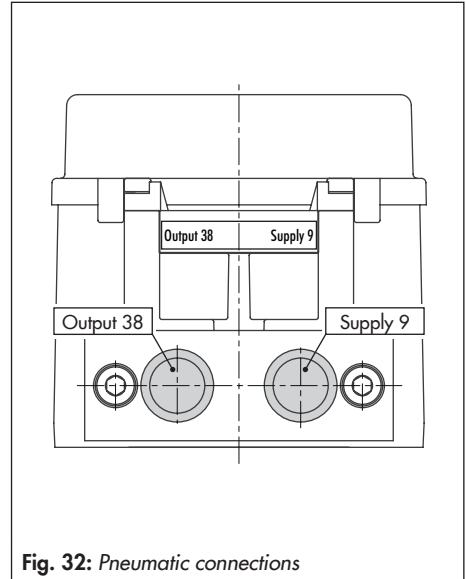


Fig. 32: Pneumatic connections

### 5.15.1 Connecting the supply air

#### **📌 NOTICE**

*Risk of malfunction due to incorrect sequence of mounting, installation and start-up.*

*Keep the following sequence.*

1. *Remove the protective caps from the pneumatic connections.*
2. *Mount the positioner on the valve.*
3. *Connect the supply air.*
4. *Connect the electrical power.*
5. *Perform settings.*

## Mounting and start-up

The pneumatic connections in the connecting plate, pressure gauge mounting block and connection block are optionally designed as a bore with ¼ NPT or G ¼ thread. Customary fittings for metal or copper tubing or plastic hoses can be used.

### Signal pressure connection

The signal pressure connection depends on how the positioner is mounted onto the actuator:

- **Type 3277 Actuator**  
The signal pressure connection is fixed.
- **Attachment according to IEC 60534-6 (NAMUR)**  
For "actuator stem retracts" fail-safe action: connect the signal pressure to the connection on top of the actuator.  
For "actuator stem extends" fail-safe action: connect the signal pressure to the connection on the bottom of the actuator.
- **Rotary actuators**  
For rotary actuators, the manufacturer's specifications for connection apply.

## 5.15.2 Signal pressure gauges



### Tip

To monitor the supply air and signal pressure, we recommend mounting pressure gauges (see accessories in section 3.5).

### Mounting the pressure gauges:

- See section 5.4 and section Fig. 8

## 5.15.3 Supply pressure

The required supply air pressure depends on the bench range and the actuator's direction of action (fail-safe action).

The bench range is written on the nameplate either as the bench range or signal pressure range depending on the actuator. The direction of action is marked FA or FE or by a symbol.

### Actuator stem extends FA (AIR TO OPEN)

Fail-close (for globe and angle valves):

- Required supply pressure = Upper bench range value + 0.2 bar, at least 1.4 bar.

### Actuator stem retracts FE (AIR TO CLOSE)

Fail-open (for globe and angle valves):

For tight-closing valves, the maximum signal pressure  $p_{st,max}$  is roughly estimated as follows:

$$p_{st,max} = F + \frac{d^2 \cdot \pi \cdot \Delta p}{4 \cdot A} \text{ [bar]}$$

d = Seat diameter [cm]

$\Delta p$  = Differential pressure across the valve [bar]

A = Actuator area [cm<sup>2</sup>]

F = Upper bench range value of the actuator [bar]

**If there are no specifications, calculate as follows:**

- Required supply pressure = Upper bench range value + 1 bar



### 5.15.4 Signal pressure (output)

The signal pressure at the output (38) of the positioner can be restricted to 1.4 bar, 2.4 bar or 3.7 bar in Code 16.

The limitation is not activated [No] by default.

## 5.16 Electrical connections

For electrical installation, observe the relevant electrotechnical regulations and the accident prevention regulations that apply in the country of use. In Germany, these are the VDE regulations and the accident prevention regulations of the employers' liability insurance.

### DANGER

**Risk of fatal injury due to the formation of an explosive atmosphere.**

The following regulations apply to installation in hazardous areas: EN 60079-14 (VDE 0165, Part 1) Explosive Atmospheres – Electrical Installations Design, Selection and Erection.

### WARNING

*Incorrect electrical connection will render the explosion protection unsafe.*

- Adhere to the terminal assignment.
- Do not undo the enameled screws in or on the housing.
- Do not exceed the maximum permissible values specified in the EC type examination certificates when interconnecting intrinsically safe electrical equipment ( $U_i$  or  $U_o$ ,  $I_i$  or  $I_o$ ,  $P_i$  or  $P_o$ ,  $C_i$  or  $C_o$  and  $L_i$  or  $L_o$ ).

The ambient temperature ranges of the tables in the EC type examination certificate apply for the assignment between the permissible ambient temperature, temperature class, maximum short-circuit currents and maximum power  $P_i$  and  $P_o$ .

**The following applies additionally:** For positioners in type of protection Ex tb (Type 3730-25) and type of protection Ex nA (Type 3730-28), the cable glands and blanking plugs must be certified according to EN 60079-7 (Ex e).

### Selecting cables and wires

Observe **Clause 12 of EN 60079-14** for installation of the intrinsically safe circuits.

Clause 12.2.2.7 applies when running multi-core cables or wires with more than one intrinsically safe circuit.

The radial thickness of the insulation of a conductor for common insulating materials (e.g. polyethylene) must not be smaller than 0.2 mm. The diameter of an individual wire in a fine-stranded conductor must not be smaller than 0.1 mm. Protect the conductor ends against splicing, e.g. by using wire-end ferrules.

When two separate cables or wires are used for connection, an additional cable gland can be installed. Seal cable entries left unused with plugs. Fit equipment used in ambient temperatures **below  $-20\text{ °C}$**  with metal cable entries.

### Equipment for use in zone 2/zone 22

In equipment operated according to type of protection Ex nA (non-sparking equipment)

## Mounting and start-up

according to EN 60079-15, circuits may be connected, interrupted or switched while energized only during installation, maintenance or repair.

The special conditions of use mentioned in the statement of conformity are to be observed for the rated values and the installation of the series-connected fuse for interconnection of Ex nA circuits.

For Ex nA equipment (non-sparking equipment), circuits may be connected, interrupted or switched while energized only during installation, maintenance or repair.

- Positioners with type of protection Ex nA or Ex tc can be used with a closed cover (no window) or with a cover with window.
- The Types 3730-21, 3730-25 and 3730-28 Positioners are 100 % identical in design, except for the marking and the housing cover.
- For type of protection Ex nA, the VCC connection in the interface adapter must be connected in series with a fuse according to IEC 60127, 250 V F or T with a fuse rating of  $I_N \leq 40$  mA.
- The signal current circuit must be connected in series with a fuse according to IEC 60127-2/VI, 250 V T with a fuse rating of  $I_N \leq 63$  mA.
- The transmitter current circuit must be connected in series with a fuse according to IEC 60127-2/VI, 250 V T with a fuse rating of  $I_N \leq 40$  mA.

The fuses must be installed outside the hazardous area.

## Cable entry

Cable entry with M20x1.5 cable gland, 6 to 12 mm clamping range.

There is a second M20x1.5 threaded hole in the housing that can be used for additional connection, when required. The screw terminals are designed for wire cross-sections of 0.2 to 2.5 mm<sup>2</sup>. Tighten the screws by 0.5 to 0.6 Nm.

The **wires for the set point** must be connected to the terminals 11 and 12 located in the housing.

Only use a **current source**. OVERLOAD appears on the display when the set point exceeds 22 mA.

---

### ! NOTICE

*The connection of a voltage source ( $U \geq 7$  V or  $U \geq 2$  V when connected to the wrong pole) can damage the positioner.*

*Only use a current source and never a voltage source!*

---

In general, it is not necessary to connect the positioner to a bonding conductor. Should this be required, however, this conductor can be connected inside the device.

Depending on the version, the positioner is equipped with **inductive limit switches and/or a solenoid valve**.

The **position transmitter** is operated on a two-wire circuit. The usual supply voltage to terminals 31 and 32 is 24 V DC. Taking the resistance of the supply leads into account, the voltage at the position transmitter terminals can be between at least 12 and 30 V DC at the maximum.

Refer to Fig. 33 or to the label on the terminal block.

**NOTICE**

*Malfunction due the current falling below minimum current.*

*Do not allow the set point to fall below 3.8 mA.*

**Accessories**

<b>Cable glands M20x1.5</b>	Order no.
Black plastic (6 to 12 mm clamping range)	8808-1011
Blue plastic (6 to 12 mm clamping range)	8808-1012
Nickel-plated brass (6 to 12 mm clamping range)	1890-4875
Nickel-plated brass (10 to 14 mm clamping range)	1922-8395
Stainless steel 1.4305 (8 to 14.5 mm clamping range)	8808-0160

<b>Adapter M20x1.5 to ½ NPT</b>	Order no.
Powder-coated aluminum	0310-2149
Stainless steel	1400-7114

**Note**

*In positioners for attachment according to VDI/VDE 3847-1, the terminal designation of the limit switches 41/42 and 51/52 as well as the OPEN and CLOSED wording can be changed by turning the terminal label which is printed on both sides.*

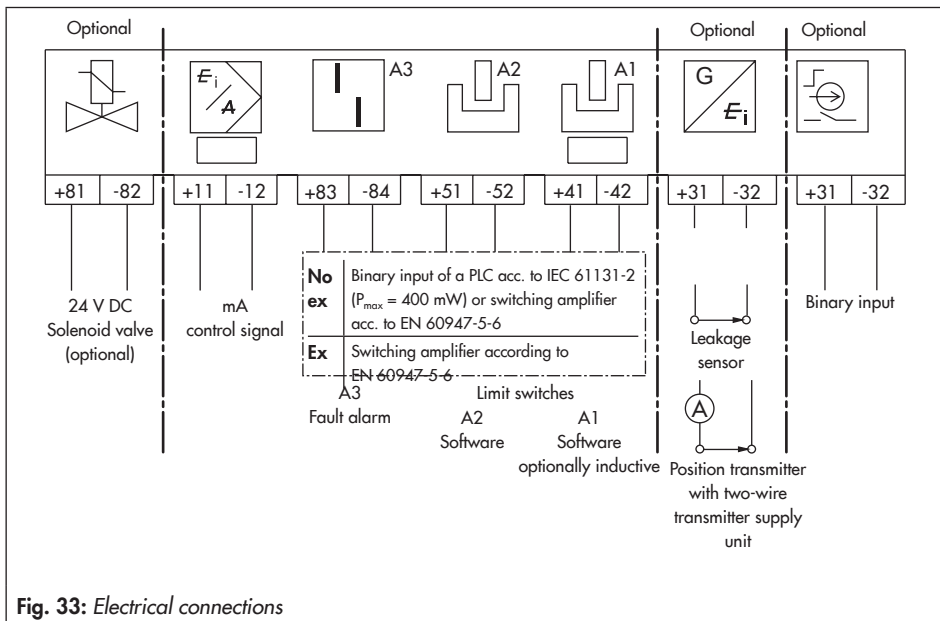
## 5.16.1 Connecting the electrical power

### NOTICE

Risk of malfunction due to incorrect sequence of mounting, installation and start-up.  
Keep the following sequence.

1. Remove the protective caps from the pneumatic connections.
2. Mount the positioner on the valve.
3. Connect the supply air.
4. Connect the electrical power.
5. Perform settings.

→ Connect the electrical power (mA signal) as shown in Fig. 33.



## 5.16.2 Switching amplifier according to EN 60947-5-6

For operation of the limit switches, switching amplifiers must be connected in the output circuit. They must comply with the limit values of the output circuits conforming to EN 60947-5-6.

→ Observe the relevant regulations for installation in hazardous areas.

For applications in safe areas (non-hazardous areas), limit switches can be directly interconnected to the binary input of the PLC in accordance with IEC 61131. This applies to the standard operating range for digital inputs according to Clause 5.2.1.2 of IEC 61131-2 with the rated voltage of 24 V DC.



## 6 Operation

### ⊗ Rotary pushbutton

The rotary pushbutton is located underneath the front protective cover. The positioner is operated on site using the rotary pushbutton:

Turn ⊗: Select codes and values

Press ⊗: confirm setting.

### AIR TO OPEN/AIR TO CLOSE slide switch

- AIR TO OPEN applies to a valve opening as the signal pressure increases.
- AIR TO CLOSE applies to a valve closing as the signal pressure increases.

The signal pressure is the pneumatic pressure at the output of the positioner applied to the actuator.

### Volume restriction Q

The volume restriction serves to adapt the air output capacity to the size of the actuator. Depending on the air passage at the actuator, two fixed settings are available.

- For actuators smaller than 240 cm<sup>2</sup> and with a signal pressure connection at the side (Type 3271-5), set restriction to MIN SIDE.
- For a connection at the back (Type 3277-5), set restriction to MIN BACK.
- For actuators 240 cm<sup>2</sup> and larger, set to MAX SIDE for a side connection and to MAX BACK for a connection at the back.

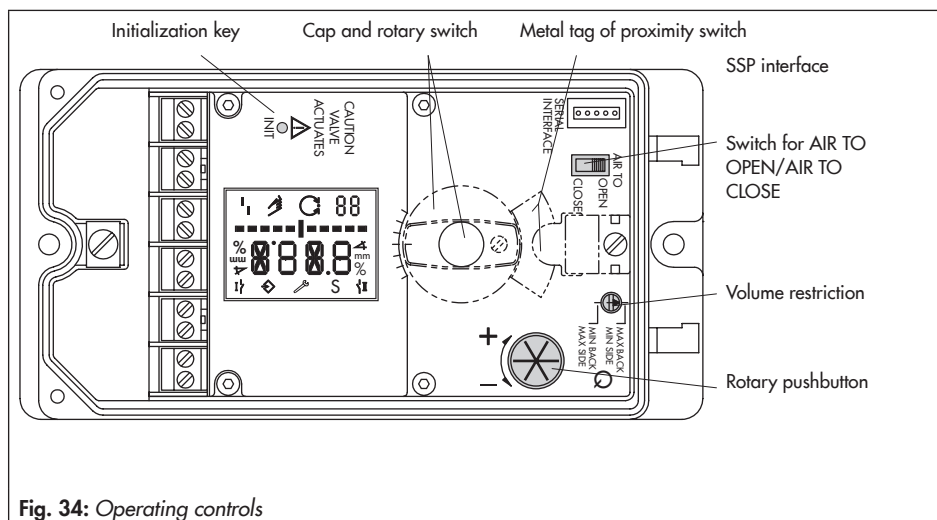
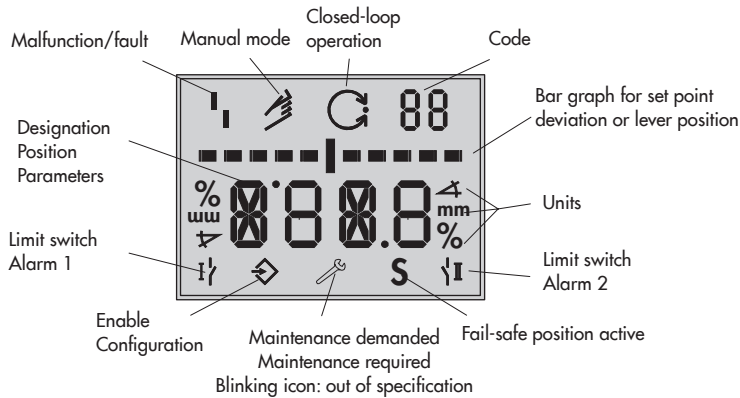


Fig. 34: Operating controls

## Operation



<b>AUTO</b>	Automatic	<b>TunE</b>	Initialization in progress
<b>CL</b>	Clockwise	<b>YES</b>	Available/active
<b>CCL</b>	Counterclockwise	<b>ZP</b>	Zero calibration
<b>Err</b>	Error	↗↗	Increasing/increasing
<b>ESC</b>	Stop	↗↘	Increasing/decreasing
<b>HI</b>	ix higher than 21.6 mA	⊙ blinks	Emergency mode (see error code 62)
<b>LO</b>	ix lower than 2.4 mA	⚙ blinks	Initialization missing
<b>LOW</b>	w too low	<b>S</b>	Valve in mechanical fail-safe position
<b>MAN</b>	Manual setting		
<b>MAX</b>	Maximum range		
<b>No</b>	Not available/not active		
<b>NOM</b>	Rated travel		
<b>O/C</b>	Type of application: On/off valve ▶ EB 8389		
<b>OVERLOAD</b>	x > 22 mA		
<b>RES</b>	Reset		
<b>RUN</b>	Start		
<b>SAFE</b>	Fail-safe position		
<b>SUB</b>	Substitute calibration		
<b>tESinG</b>	Test function active		




Fig. 35: Display





## Readings


Icons assigned to certain codes, parameters and functions are indicated on the display.

### Operating modes:

-  **(manual mode)**  
The positioner follows the manual set point (Code 1) instead of the mA signal.  
 blinks: The positioner is not initialized. Operation only possible over manual set point (Code 1).
-  **(automatic mode)**  
The positioner is in closed-loop operation and follows the mA signal.
- **S SAFE**  
The positioner vents the output. The valve moves to the mechanical fail-safe position.




### Bar graph:

In manual  and automatic  modes, the bars indicate the set point deviation that depends on the sign (+/-) and the value. One bar element appears per 1 % set point deviation.

If the positioner has not been initialized, ( blinks on the display), the bar graph indicates the lever position in degrees in relation to the mid-axis. One bar element corresponds to approximately a 5° angle of rotation. The fifth bar element blinks (reading > 30°) if the permissible angle of rotation has

been exceeded. Lever and pin position must be checked.

### Status messages

-  Maintenance alarm
-  Maintenance demanded/Maintenance required
-  blinks: Out of specification

These icons indicate that an error has occurred.

A classified status can be assigned to each error. Classifications include “No message”, “Maintenance required”, “Maintenance demanded” and “Maintenance alarm” (see ► EB 8389 on EXPERTplus valve diagnostics).

### Enable configuration

This indicates that the codes marked with an asterisk (\*) in the code list are enabled for configuration (see section 11.3).

## 6.1 Serial interface

The positioner must be supplied with at least 4 mA.

The positioner can be connected directly to the computer over the local serial interface and the serial interface adapter.

The operator software is TROVIS-VIEW with installed device module 3730-2.



## 7 Operating the positioner



### NOTICE

Risk of malfunction due to incorrect sequence of mounting, installation and start-up. Keep the following sequence.

1. Remove the protective caps from the pneumatic connections.
2. Mount the positioner on the valve.
3. Connect the supply air.
4. Connect the electrical power.
5. Perform settings.

### Reading after connecting the electrical power supply:



After *tESinG* runs across the display, the  fault alarm icon appears and the  icon blinks on the display when the **positioner has not been initialized**. The reading indicates the lever position in degrees in relation to the mid-axis.

Code 0 is displayed when a **positioner has been initialized**. The positioner is in the last active operating mode.

The positioner performs a test in the start-up phase while following its automation task at the same time.

### WARNING

Risk of injury due to the actuator stem extending or retracting. Do not touch or block the actuator stem.

During the start-up phase, operation on site is unrestricted, yet write access is limited.

## 7.1 Determining the fail-safe position

Define the fail-safe position of the valve (0 %) taking the valve type and the actuator's direction of action into account. Position the AIR TO OPEN/AIR TO CLOSE slide switch accordingly:

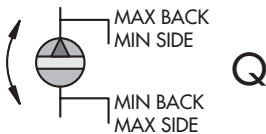
- **AIR TO OPEN** setting  
Signal pressure opens the valve, e.g. for a fail-close valve  
The AIR TO OPEN setting always applies to double-acting actuators.
- **AIR TO CLOSE** setting  
Signal pressure closes the valve, e.g. for a fail-open valve

**For checking purposes:** after successfully completing initialization, the positioner display must read 0 % when the valve is closed and 100 % when the valve is open. If this is not the case, change the slide switch position and re-initialize the positioner.

### **i** Note

The switch position is prompted prior to an initialization. After an initialization has been completed, changing the switch position does not have any effect on the operation of the positioner.

## 7.2 Adjusting the volume restriction Q



Signal pressure	Transit time	
	<1 s	≥1 s
Connection at the side	MIN SIDE	MAX SIDE
Connection at the back	MIN BACK	MAX BACK

\* Intermediate settings are not permitted.

**Fig. 36:** Volume restriction Q

The volume restriction Q serves to adapt the air output capacity to the size of the actuator:

- Actuators with a **transit time < 1 s**, e.g. linear actuators with an effective area smaller than 240 cm<sup>2</sup>, require a restricted air flow rate (MIN).
- Actuators with a **transit time ≥ 1 s** do not require the air flow rate to be restricted (MAX).

The position of volume restriction Q also depends on how the signal pressure is routed at the actuator in **SAMSON actuators**:

**'SIDE' inscription**

- For actuators with a signal pressure connection at the side, e.g. Type 3271-5
- For actuators from other manufacturers

**'BACK' inscription**

- For actuators with a signal pressure connection at the back, e.g. Type 3277-5

**The following applies to positioners with optional analog input x:** the MIN SIDE setting must always be used for actuators with an air volume of less than one liter.





**NOTICE**

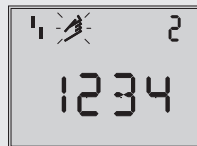
*Malfunction due to changed start-up settings.*

*Initialize an initialized positioner again after the position of the volume restriction has been changed.*

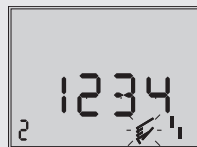
### 7.3 Adapting the display direction

To adapt the reading on the display to the mounting situation of the actuator, the display contents can be turned by 180°. If the displayed data appear upside down, proceed as follows:

1. Turn  until Code 2 appears.
2. Press , the code number 2 blinks.
3. Turn  and select the required reading direction.
4. Press  to confirm.



Reading direction for right attachment of pneumatic connections



Reading direction for left attachment of pneumatic connections

### 7.4 Limiting the signal pressure






If the maximum actuator force may cause damage to the valve, the signal pressure must be limited.

➔ Do not activate pressure limitation for double-acting actuators (AIR TO OPEN (ATO) fail-safe position). Default setting is 'No'.

Enable configuration at the positioner before limiting the signal pressure.

#### Enable configuration:





If no settings are entered within 120 seconds, the enabled configuration function becomes invalid.

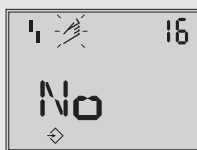
1. Turn  until Code 3 appears (reading: No).
2. Press , the code number 3 blinks.
3. Turn  until YES appears.
4. Press  to confirm (reading: ).



Enable configuration  
Default: No


#### Limit the signal pressure:

1. Turn  until Code 16 appears.
2. Press , the code number 16 blinks.
3. Turn  until the required pressure limit (1.4/2.4/3.7 bar) appears.
4. Press  to confirm.



Pressure limit  
Default: No

### 7.5 Checking the operating range of the positioner

To check the mechanical attachment and the proper functioning, the valve should be moved through the operating range of the positioner in the  manual mode with the manual set point.

Select manual mode (↻):

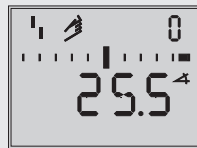
1. Turn (⊗) until Code 0 appears.
2. Press (⊗), the code number 0 blinks.
3. Turn (⊗) until MAN appears.
4. Press (⊗). The positioner changes to the manual mode (↻).



Operating mode  
Default: MAN

Check the operating range:

5. Turn (⊗) until Code 1 appears.
6. Press (⊗), the code number 1 and ↻ icon blink.
7. Turn (⊗) until the pressure in the positioner builds up and the control valve moves to its final positions so that the travel/angle can be checked.



Manual set point w  
(current angle of  
rotation is indicated)

The angle of rotation of the lever on the back of the positioner is indicated.

A horizontal lever (mid position) is equal to 0°.

To ensure the positioner is working properly, the outer bar elements must not blink while the valve is moving through the operating range.

Exit Code 1 by pressing the rotary pushbutton (⊗).

The permissible range has been exceeded when the displayed angle is more than 30° and the outer right or left bar element blinks. The positioner goes to the fail-safe position (SAFE). After canceling the fail-safe position (SAFE) (see section 7.11.2) it is **absolutely** essential that you check the lever and pin position as described in section 5.

**⚠ WARNING**

*Risk of injury due to the actuator stem extending or retracting.*

*Before exchanging the lever or changing the pin position, disconnect the supply air and electrical auxiliary power.*

### 7.6 Initializing the positioner

---

#### **WARNING**

*Risk of injury by exposed moving parts on the positioner, actuator or valve.  
Do not touch or block exposed moving parts.*

---

#### **NOTICE**

*The process is disturbed by the movement of the actuator or valve.  
Do not perform the initialization while the process is running. First isolate the plant by closing the shut-off valves.*

---

- ➔ Check the max. permissible signal pressure of the valve before starting initialization. During initialization, the positioner issues an output signal pressure up to the maximum supply pressure supplied. If necessary, limit the signal pressure by connecting an up-stream pressure reducing valve.
- 

#### **Note**

*Reset positioner to its default settings (see section 7.9) before mounting it on a different actuator or changing its mounting position.*

---

During initialization the positioner adapts itself optimally to the friction conditions and the signal pressure required by the control valve. The type and extent of auto tuning depends on the initialization mode selected:

- **Maximum range (MAX)** (standard range)  
Initialization mode for simple start-up of valves with two clearly defined mechanical end positions, e.g. three-way valves (see section 7.6.1)
- **Nominal range (NOM)**  
Initialization mode for all globe valves (see section 7.6.2)
- **Manually selected range (MAN)**  
Initialization mode for globe valves with an unknown nominal range (see section 7.6.3)
- **Substitute calibration (SUB)**  
This mode allows a positioner to be replaced while the plant is running, with the least amount of disruption to the plant (see section 7.6.4).

For normal operation, simply start initialization by pressing the INIT key after mounting the positioner on the valve and defining the fail-safe position and setting the volume restriction.

---




The positioner only needs to work with its default settings. If necessary, perform a reset (see section 7.9).

**i Note**

An initialization procedure in progress can be canceled by pressing the rotary pushbutton. STOP is displayed for three seconds and the positioner changes to the fail-safe position (SAFE). Clear the fail-safe position again over Code 0 (see section 7.11.2).

The time required for the initialization procedure depends on the actuator transit time and can take a few minutes.

After a successful initialization, the positioner runs in closed-loop operation indicated by the  closed-loop operation icon.

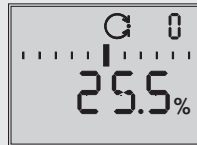
A malfunction leads to the process being canceled. The initialization error is displayed according to how it has been classified by the condensed state. Refer to section 9.




Alternating readings  
Initialization in progress  
Icon depending on  
initialization mode  
selected



Bar graph display  
indicating the progress  
of the initialization



Initialization successfully  
completed. Positioner in  
automatic mode ()

**i Note**

When Code 48 - h0 = YES, the diagnostics automatically start to plot the reference graphs (drive signal steady-state d1 and hysteresis d2) after initialization has been completed. This is indicated by tEST and d1 or d2 appearing on the display in alternating sequence.

An error during the plotting of the reference graphs is indicated on the display over Code 48 - h1 and Code 81.

The reference graphs do not have any effect on closed-loop operation.

## Operating the positioner

### Fail-safe position AIR TO CLOSE

If the slide switch is set to AIR TO CLOSE, the positioner automatically switches to the direction of action increasing/decreasing (↗↘) after initialization has been completed. This results in the assignment (left) between set point and valve position.

The tight-closing function has been activated.

**Set Code 15** (set point cutoff increase) to 99 % for three-way valves.






Fail-safe position	Direction of action	Set point Valve	
		CLOSED at	OPEN at
Actuator stem extends (FA) AIR TO OPEN	↗↗	0 %	100 %
Actuator stem retracts (FE) AIR TO CLOSE	↗↘	100 %	0 %

### 7.6.1 MAX – Initialization based on maximum range

The positioner determines travel/angle of rotation of the closing member from the CLOSED position to the opposite travel stop and adopts this travel/angle of rotation as the operating range from 0 to 100 %.

#### Enable configuration:





If no settings are entered within 120 seconds, the enabled configuration function becomes invalid.

1. Turn  until Code 3 appears (reading: No).
2. Press , the code number 3 blinks.
3. Turn  until YES appears.
4. Press  to confirm (reading: ).



Enable configuration  
Default: No

#### Select the initialization mode:

1. Turn  until Code 6 appears.
2. Press , the code number 6 blinks.
3. Turn  until MAX appears.
4. Press  to confirm the MAX initialization mode.



Default: MAX





**Start initialization:**

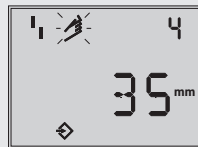
→ Press INIT key.

The nominal travel/angle of rotation is indicated in % after initialization. Code 5 (nominal range) remains locked. The parameters for travel/angle range start (Code 8) and travel/angle range end (Code 9) can also only be displayed and modified in %.

For a reading in mm/°, enter the pin position (Code 4).

**Enter the pin position:**

1. Turn  until Code 4 appears.
2. Press  , the code number 4 blinks.
3. Turn  to select pin position on lever (see relevant section on attachment).
4. Press  to confirm.



Pin position  
Default: No

The reading of the nominal range appears in mm/°.

## 7.6.2 NOM – Initialization based on nominal range

The calibrated sensor allows the effective valve travel to be set very accurately. During initialization, the positioner checks whether the control valve can move through the indicated nominal range (travel or angle) without collision. If this is the case, the indicated nominal range is adopted with the limits of travel/angle range start (Code 8) and travel/angle range end (Code 9) as the operating range.






**i Note**

*The maximum possible travel must always be greater than the nominal travel entered. If this is not the case, initialization is automatically canceled (error message Code 52) because the nominal travel could not be achieved.*

## Operating the positioner

### Enable configuration:









If no settings are entered within 120 seconds, the enabled configuration function becomes invalid.

1. Turn  until Code 3 appears (reading: No).
2. Press , the code number 3 blinks.
3. Turn  until YES appears.
4. Press  to confirm (reading: ).



Enable configuration  
Default: No

### Enter the pin position and nominal range:

1. Turn  until Code 4 appears.
2. Press , the code number 4 blinks.
3. Turn  to select pin position on lever (see relevant section on attachment).
4. Press  to confirm.
5. Turn  until Code 5 appears.
6. Press , the code number 5 blinks.
7. Turn  and set nominal travel of the valve.
8. Press  to confirm.







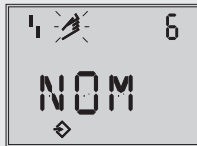
Pin position  
Default: No



Nominal range  
(locked when Code 4 =  
No)

### Select the initialization mode:

1. Turn  until Code 6 appears.
2. Press , the code number 6 blinks.
3. Turn  until NOM appears.
4. Press  to confirm the NOM initialization mode.



Init mode  
Default: MAX

**Start initialization:**

- Press INIT key.
- After the initialization has been successfully completed:  
Check the direction of action (Code 7) and, if necessary, change it.

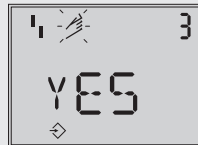
### 7.6.3 MAN – Initialization based on a manually selected range

Before starting initialization, move the control valve manually to the OPEN position. Turn the rotary pushbutton (⊗) clockwise in small steps. The valve must be moved with a monotonically increasing signal pressure. The positioner calculates the differential travel/angle from the OPEN and CLOSED positions and adopts it as the operating range with limits of lower travel/angle range value (Code 8) and upper travel/angle range value (Code 9).

**Enable configuration:**

If no settings are entered within 120 seconds, the enabled configuration function becomes invalid.

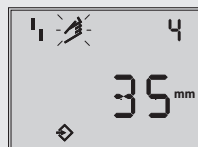
1. Turn ⊗ until Code 3 appears (reading: No).
2. Press ⊗, the code number 3 blinks.
3. Turn ⊗ until YES appears.
4. Press ⊗ to confirm (reading: ⇨).



Enable configuration  
Default: No

**Enter the pin position:**





1. Turn ⊗ until Code 4 appears.
2. Press ⊗, the code number 4 blinks.
3. Turn ⊗ to select pin position on lever (see relevant section on attachment).
4. Press ⊗ to confirm.



Pin position  
Default: No

## Operating the positioner









### Select the initialization mode:

1. Turn  until Code 6 appears.
2. Press , the code number 6 blinks.
3. Turn  until MAN appears.
4. Press  to confirm the MAN initialization mode.



Init mode  
Default: MAX

### Enter OPEN position:

1. Turn  until Code 0 appears.
2. Press , the code number 0 blinks.
3. Turn  until MAN appears.
4. Press  to confirm.
5. Turn  until Code 1 appears.
6. Press , the code number 1 blinks.
7. Turn  until the valve reaches its OPEN position.
8. Press  to confirm the OPEN position.



Manual set point  
(current angle of rotation is indicated)

### Start initialization:

- Press INIT key.

## 7.6.4 Sub – Substitute calibration

A complete initialization procedure takes several minutes and requires the valve to move through its entire travel range several times. In the SUB initialization mode, the control parameters are estimated and not determined by an initialization procedure. As a result, a high level of accuracy cannot be expected. A different initialization mode should be selected if the plant allows it.

The substitute calibration is used to replace a positioner while the process is running. For this purpose, the control valve is usually fixed mechanically in a certain position or pneumatically by means of a pressure signal which is routed to the actuator externally. The blocking position ensures that the plant continues to operate with this valve position.






By entering the blocking position (Code 35), closing direction (Code 34), pin position (Code 4), nominal range (Code 5) and direction of action (Code 7), the positioner can calculate the positioner configuration.

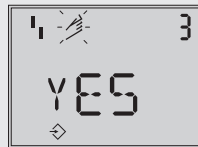
**NOTICE**

Perform a reset before re-initializing the positioner if the substitute positioner has already been initialized. Refer to section 7.9.

**Enable configuration:**









If no settings are entered within 120 seconds, the enabled configuration function becomes invalid.

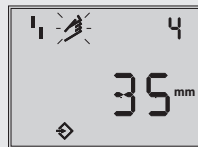
1. Turn  until Code 3 appears (reading: No).
2. Press , the code number 3 blinks.
3. Turn  until YES appears.
4. Press  to confirm (reading: .



Enable configuration  
Default: No

**Enter the pin position and nominal range:**

1. Turn  until Code 4 appears.
2. Press , the code number 4 blinks.
3. Turn  to select pin position on lever (see relevant section on attachment).
4. Press  to confirm.
5. Turn  until Code 5 appears.
6. Press , the code number 5 blinks.
7. Turn  and set nominal travel of the valve.
8. Press  to confirm.







Pin position  
Default: No

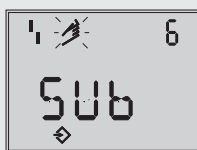


Nominal range  
(locked when Code 4 = No)

## Operating the positioner





### Select the initialization mode:

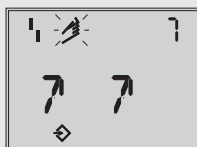
1. Turn  until Code 6 appears.
2. Press , the code number 6 blinks.
3. Turn  until SUB appears.
4. Press  to confirm the SUB initialization mode.



Init mode  
Default: MAX





### Enter the direction of action:

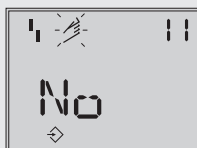
1. Turn  until Code 7 appears.
2. Press , the code number 7 blinks.
3. Turn  to select the direction of action (↗/↖).
4. Press  to confirm.



Direction of action  
Default: ↗↖

### Deactivate travel limit:

1. Turn  until Code 11 appears.
2. Press , the code number 11 blinks.
3. Turn  until No appears.
4. Press  to deactivate the travel limit function.







Travel limitation  
Default: No

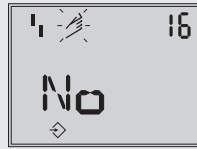
### Change pressure limit and control parameters:

#### Note

Do not change the pressure limit (Code 16). Only change the control parameters  $K_p$  (Code 17) and  $T_v$  (Code 18) if the settings of the replaced positioner are known.



1. Turn  until the required Code 16/17/18 appears.
2. Press , the code number 16/17/18 blinks.
3. Turn  to set the control parameter selected.
4. Press  to confirm.



Pressure limit  
Default: No










K<sub>p</sub> level  
Default: 7



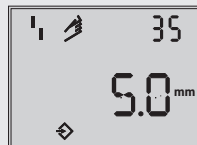
T<sub>v</sub> level  
Default: 2

#### Enter closing direction and blocking position:

1. Turn  until Code 34 appears.
2. Press , the code number 34 blinks.
3. Turn  and set the closing direction (CCL = counterclockwise/CL = clockwise).
4. Press  to confirm.
5. Turn  until Code 35 appears.
6. Press , the code number 35 blinks.
7. Turn  to set the blocking position, e.g. 5 mm (read off at travel indicator scale of the blocked valve or measure with a ruler).
8. Set switch for fail-safe position AIR TO OPEN or AIR TO CLOSE according to section 7.1.
9. Adjust volume restriction as described in section 7.2.



Closing direction  
(direction of rotation causing the valve to move to the CLOSED position (view onto positioner display)  
Default: CCL (counterclockwise)



Blocking position  
Default: 0

## Operating the positioner










### Start initialization:

- Press INIT key.  
The positioner switches to MAN mode.  
The blocking position is indicated.

Since initialization has not been completed, the error code 76 (no emergency mode) and possibly also error code 57 (control loop) may appear on the display. These alarms do not influence the positioner's readiness for operation.

### Cancel the blocking position and change to automatic mode (AUTO):

For the positioner to follow its set point again, the blocking position must be canceled and the positioner must be set to automatic mode as follows:

1. Turn  until Code 1 appears.
2. Press , the code number 1 and  icon blink.
3. Turn  to build up pressure in the positioner to move the valve slightly past the blocking position.
4. Press  to cancel the mechanical blocking.
5. Turn  until Code 0 appears.
6. Press , the code number 0 blinks.
7. Turn  until *AUTO* appears.
8. Press  to confirm. The positioner switches to automatic mode. The current valve position is indicated in %.

- If the positioner shows a tendency to oscillate in automatic mode, the parameters  $K_p$  and  $T_v$  must be slightly corrected. Proceed as follows:
  - Set  $T_v$  (Code 18) to 4.
  - If the positioner still oscillates, the gain  $K_p$  (Code 17) must be decreased until the positioner shows a stable behavior.

### Zero point calibration

- Finally, if process operations allow it, the zero point must be calibrated according to section 7.7.

## 7.7 Zero calibration

In case of inconsistencies in the closed position of the valve, e.g. with soft-seated plugs, it might be necessary to recalibrate zero.

### **⚠ WARNING**

*Risk of injury due to the actuator stem extending or retracting.  
Do not touch or block the actuator stem.*






### **! NOTICE**

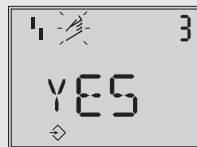
*The process is disturbed by the movement of the actuator stem.  
Do not perform zero calibration while the process is running. First isolate the plant by closing the shut-off valves.*

The positioner must be connected to the supply air to perform the zero calibration.

### **Enable configuration:**




If no settings are entered within 120 seconds, the enabled configuration function becomes invalid.

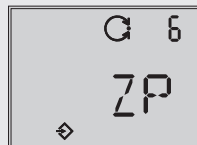
1. Turn  until Code 3 appears (reading: No).
2. Press , the code number 3 blinks.
3. Turn  until YES appears.
4. Press  to confirm (reading: ).



Enable configuration  
Default: No

### **Perform zero calibration:**

1. Turn  until Code 6 appears.
  2. Press , the code number 6 blinks.
  3. Turn  until ZP appears.
- Press INIT key.  
Zero calibration starts. The positioner moves the valve to the CLOSED position and recalibrates the internal electrical zero point.



Init mode  
Default: MAX

### 7.8 Adjusting inductive limit switch

The positioner version with an inductive limit switch has an adjustable tag (1) mounted on the axis of rotation, which operates the proximity switch (3).

For operation of the inductive limit switch, the corresponding switching amplifier (see section 5.16.2) must be connected to the output circuit.

When the tag (1) is located in the inductive field of the switch, the switch assumes a high resistance. When it moves outside the field, the switch assumes a low resistance.

Normally, the limit switch is adjusted in such a way that it will provide a signal in both end positions of the valve. The switch, however, can also be adjusted to indicate intermediate valve positions.

The required switching function, i.e. whether the output relay is to be picked up or released when the tag enters the field, must be selected at the switching amplifier, if required.

---

#### **i** Note

*The inductive limit switch replaces the software limit switch A1 with terminal assignment +41/-42.*

*Each switching position can optionally be set to indicate when the tag has entered the field or when it has left the field.*

*The second software limit switch remains effective, the function of the software limit switch A1 is disabled.*

---

#### **Software adaptation**

- Code 38 (inductive alarm is set to YES).
- The inductive limit switch is connected to the terminals +41/-42 (see section 5.16).
- The device is set up accordingly in the delivered state.

#### **Adjusting the switching point**

---

#### **i** Note

*During adjustment or testing, the switching point must always be approached from mid-position (50 %).*

---

To guarantee the switching under all ambient conditions, adjust the switching point approx. 5 % before the mechanical stop (OPEN – CLOSED).

**For CLOSED position:**

1. Initialize the positioner.
2. Move the valve to 5 % in the MAN mode (see display).
3. Adjust the tag at the yellow adjustment screw (2) until the tag enters or leaves the field and the switching amplifier responds.  
You can measure the switching voltage as an indicator.

**Contact function:**

- Tag leaving the field > contact is closed.
- Tag entering the field > contact is opened.

**For OPEN position:**

1. Initialize the positioner.
2. Move the valve to 95 % in the MAN mode (see display).
3. Adjust the tag (1) at the yellow adjustment screw (2) until the tag enters or leaves the field of the proximity switch (3).  
You can measure the switching voltage as an indicator.

**Contact function:**

- Tag leaving the field > contact is closed.
- Tag entering the field > contact is opened.

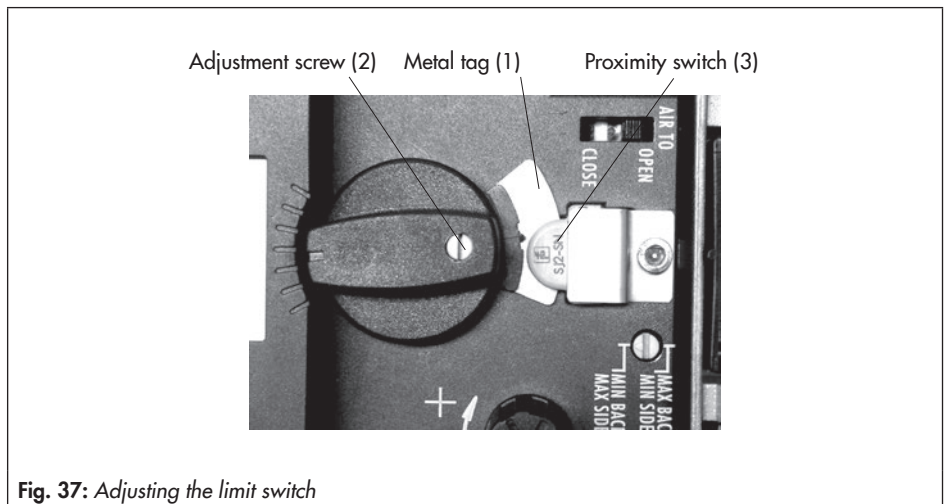







Fig. 37: Adjusting the limit switch

### 7.9 Reset to default settings

This function resets all start-up and setting parameters as well as the diagnosis to the factory default settings (see code list in section 11.5).

#### Enable configuration:






If no settings are entered within 120 seconds, the enabled configuration function becomes invalid.

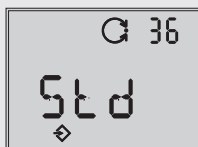
1. Turn  until Code 3 appears (reading: No).
2. Press , the code number 3 blinks.
3. Turn  until YES appears.
4. Press  to confirm (reading: ).



Enable configuration  
Default: No

#### Reset start-up parameters:

1. Turn  until Code 36 appears (reading: ).
2. Press , the code number 36 blinks.
3. Turn  until *Std* appears.
4. Press  to confirm. All start-up parameters as well as the diagnosis are reset to their default values.












Reset  
Default: No

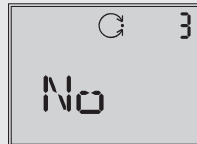
#### Note

Code 36 - diAG allows just the diagnosis data (EXPERTplus) to be reset. Refer to the Operating Instructions for EXPERTplus valve diagnostics ► EB 8389.

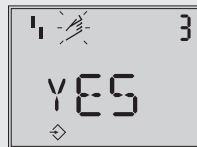
## 7.10 Enabling and selecting parameters

All codes and their meaning and default settings are listed in the code list in section 11.3. Codes which are marked with an asterisk must be enabled with Code 3 before the associated parameters can be configured as described below.

Turn  until Code 3 appears (reading: No).  
 Press , the code number 3 blinks.  
 Change the setting in Code 3.  
 Turn  until YES appears.  
 Press , reading:   
 Configuration is enabled.  
 You can now configure codes one after the other:  
 Turn  to select the required code.  
 Press  to activate the selected code. The code number starts to blink.  
 Turn  to select the setting.  
 Press  to confirm the selected setting.



Code 3  
 Configuration not enabled





Configuration enabled

If no settings are entered within 120 seconds, the enabled configuration function becomes invalid and the display returns to Code 0.

### Cancel the setting:

To cancel a value before it is confirmed (by pressing ) proceed as follows:


Turn  until ESC appears.  
 Press  to confirm.  
 The entered value is not adopted.



Canceling the reading

## 7.11 Operating modes






### 7.11.1 Automatic and manual modes

After initialization has been completed successfully, the positioner is in  automatic mode (AUTO).



Automatic mode

#### Switching to manual mode (MAN):

1. Turn  until Code 0 appears.
2. Press , reading: *AUTO*, the code number 0 blinks.
3. Turn  until *MAN* appears.
4. Press . The positioner changes to the manual mode (.






Automatic mode

The manual mode starts using the last set point of the automatic mode, ensuring a bumpless changeover. The current position is displayed in %.



Manual mode

#### Adjusting the manual set point:





1. Turn  until Code 1 appears.
2. Press , the code number 1 blinks.
3. Turn  until sufficient pressure has been built up in the positioner and the control valve moves to the required position.









The positioner automatically returns to Code 0 if no settings are made within 120 seconds, but remains in the manual mode.

### Switch to automatic mode

1. Turn  until Code 0 appears.
2. Press , the code number 0 blinks.
3. Turn  until *AUTO* appears.
4. Press . The positioner switches to automatic mode.

## 7.11.2 Fail-safe position (SAFE)





If you want to move the valve to the fail-safe position determined during start-up (see section 7.1), proceed as follows:

1. Turn  until Code 0 appears.
2. Press , reading: current operating mode (*AUTO* or *MAN*), the code number 0 blinks.
3. Turn  until *SAFE* appears.
4. Press , reading: *S*

The valve moves to the fail-safe position. If the positioner has been initialized, the current valve position in % is indicated on the display.



### Exiting the fail-safe position:

1. Turn  until Code 0 appears.
2. Press , the code number 0 blinks.
3. Turn  and select the required operating mode (*AUTO* or *MAN*).
4. Press  to confirm.
5. The positioner switches to the operating mode selected.



## 8 Servicing

### **i Note**

The positioner was checked by SAMSON before it left the factory.

- The product warranty becomes void if service or repair work not described in these instructions is performed without prior agreement by SAMSON's After-sales Service department.
- Only use original spare parts by SAMSON, which comply with the original specifications.

The positioner does not require any maintenance.

### **Housing cover**

Occasionally, the window in the cover may need to be cleaned.

### **! NOTICE**

*Incorrect cleaning will damage the window. The window is made of Makrolon® (new design) and will be damaged when cleaned with abrasive cleaning agents or agents containing solvents.*

- Do not rub the window dry.
- Do not use any cleaning agents containing chlorine or alcohol or abrasive cleaning agents.
- Use a non-abrasive, soft cloth for cleaning.

### **Filters**

There are filters with a 100 µm mesh size in the pneumatic connections for supply and output which can be removed and cleaned, if required.

### **Supply air pressure reducing stations**

The maintenance instructions of any upstream supply air pressure reducing stations must be observed.

## 8.1 Firmware update

**Firmware updates on positioners currently in operation can be performed as described below. Only individuals with a written approval may perform updates. Approved individuals are named by SAMSON's Total Quality Management and assigned a test mark.**

Laptops and computers connected to the power supply must only be interconnected with intrinsically safe equipment if the SAMSON isolated USB interface adapter (order no. 1400-9740) is connected in-between for software programming or test routines.

### **Updates outside the hazardous area:**

- ➔ Remove the positioner and perform the update outside the hazardous area.

### **Updates on site:**

- ➔ Updates on site are only permitted after the plant operator presented a signed hot work permit.

## Servicing

- After updating has been completed, add the current firmware to the nameplate (e.g. using a label).
- The individual approved by SAMSON confirms the update by attaching the assigned test mark (stamp).

## 8.2 Preparation for return shipment




Defective positioners can be returned to SAMSON for repair.

Proceed as follows to return devices to SAMSON:

1. Put the control valve out of operation.  
See associated valve documentation.
2. Remove the positioner (see section 10).
3. Send the positioner to your nearest SAMSON subsidiary. SAMSON subsidiaries are listed on our website at  
▶ [www.samson.de](http://www.samson.de) > Contact.

## 9 Malfunctions

Malfunctions are indicated on the display by error codes. Section 11.4 lists possible error messages and recommended action.

The error codes appear on the display corresponding to their status classification set over the condensed state (Maintenance required/ Maintenance demanded: , Out of specification:  blinking, Maintenance alarm: ). If 'No message' is assigned to the error code as the status classification, the error is not included in the condensed state.

A status classification is assigned to every error code in the default setting. The assignment of the status classification can be changed in TROVIS-VIEW and over the parameters of the DD. Refer to the operating instructions for the valve diagnostics

► EB 8389 on EXPERTplus valve diagnostics for more details.

To provide a better overview, the classified messages are summarized in a condensed state for the positioner according to the NAMUR Recommendation NE 107. The status messages are divided into the following categories:

### – Maintenance alarm

The positioner cannot perform its control task due to a functional fault in the positioner itself or in one of its peripherals or an initialization has not yet been successfully completed.

### – Maintenance required

The positioner still performs its control task (with restrictions). A maintenance demand or above average wear has

been determined. The wear tolerance will soon be exhausted or is reducing at a faster rate than expected. Maintenance is necessary in the medium term.

### – Maintenance demanded




The positioner still performs its control task (with restrictions). A maintenance demand or above average wear has been determined. The wear tolerance will soon be exhausted or is reducing at a faster rate than expected. Maintenance is necessary in the short term.

### – Out of specification

The positioner is running outside the specified operating conditions.

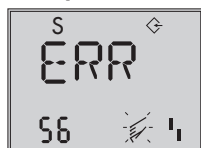
If an event is classified as “No message”, this event does not have any affect on the condensed state.

**Table 15:** Condensed state reading

Condensed state	Positioner display
Maintenance alarm	
Function check	Text e.g. <i>TUNE</i> or <i>TEST</i>
Maintenance required/ maintenance demanded	
Out of specification	 blinking

The message with the highest priority determines the condensed state in the positioner. If fault alarms exist, the possible source of error is displayed in Code 49 onwards. In this case, *ERR* is displayed.

### Example:



Example:  
Error caused by pin position

→ Refer to the code list (section 11.4) for possible causes and the recommended action.

### Fault alarm output

'Maintenance alarm' as the condensed state causes the optional fault alarm output to be switched.

- The 'Function check' condensed state can also activate the fault alarm output (Code 32).
- The 'Maintenance required/Maintenance demanded' condensed state and 'Out of specification' can also activate the fault alarm output (Code 33).

## 9.1 Confirming error messages

### Enable configuration:

1. Turn until Code 3 appears (reading: No).
2. Press , the code number 3 blinks.
3. Turn until YES appears.
4. Press to confirm (reading: ).

### Confirming error message:

1. Turn until the error code that you want appears.
2. Press to confirm the error message.

## 9.2 Emergency action

Fail-safe action is triggered by the i/p converter or solenoid valve and upon supply air failure. The positioner fully discharges its pneumatic output to the atmosphere, causing the mounted actuator to be vented. As a result, the valve moves to the fail-safe position. The fail-safe position depends on how the springs are arranged in the pneumatic actuator (air-to-close or air-to-open).

When the supply air fails, when the optional solenoid valve is triggered and after reaching the shutdown signal, all positioner functions, except open/closed loop control, remain active (including diagnostics as well as position and status feedback).



**Tip**

*Emergency action in the event of valve or actuator failure is described in the associated valve and actuator documentation.*

→ The plant operator is responsible for emergency action to be taken in the plant.

## 10 Decommissioning and removal

### **⚠ DANGER**

**Risk of fatal injury due to ineffective explosion protection.**

*The explosion protection becomes ineffective when the positioner cover is opened.*

*The following regulations apply to installation in hazardous areas: EN 60079-14 (VDE 0165, Part 1).*

### **ⓘ NOTICE**

*The process is disturbed by interrupting closed-loop control.*

*Do not mount or service the positioner while the process is running and only after isolating the plant by closing the shut-off valves.*

### 10.1 Decommissioning

To decommission the positioner before removing it, proceed as follows:

1. Disconnect and lock the air supply and signal pressure.
2. Open the positioner cover and disconnect the wires for the control signal.

### 10.2 Removing the positioner

1. Disconnect the wires for the control signal from the positioner.
2. Disconnect the lines for supply air and signal pressure (not required for direct attachment using a connection block).

3. To remove the positioner, loosen the three fastening screws on the positioner.

### 10.3 Disposal



We are registered with the German national register for waste electric equipment (stiftung ear) as a producer of electrical and electronic equipment, WEEE reg. no.: DE 62194439

- ➔ Observe local, national and international refuse regulations.
- ➔ Do not dispose of components, lubricants and hazardous substances together with your other household waste.

### **i Note**

*We can provide you with a recycling passport according to PAS 1049 on request. Simply e-mail us at [aftersaleservice@samson.de](mailto:aftersaleservice@samson.de) giving details of your company address.*

### **💡 Tip**

*On request, we can appoint a service provider to dismantle and recycle the product.*





## 11 Appendix

### 11.1 After-sales service

Contact SAMSON's After-sales Service department for support concerning service or repair work or when malfunctions or defects arise.

#### E-mail address

You can reach the After-sales Service Department at [aftersalesservice@samson](mailto:aftersalesservice@samson).

#### Addresses of SAMSON AG and its subsidiaries

The addresses of SAMSON AG, its subsidiaries, representatives and service facilities worldwide can be found on our website ([www.samson.de](http://www.samson.de)) or in all SAMSON product catalogs.

#### Required specifications

Please submit the following details:

- Order number and position number in the order
- Type, serial number, firmware version, device version

### 11.2 Certificates

The certificates valid at the time when these instructions were published are included on the next pages.

The latest certificates are available on the Internet at ► [www.samson.de](http://www.samson.de) > Product selector > 3730-2 > Downloads > Certificates

## 11.3 Code list



Code no.	Parameter – Readings/ values [default setting]	Description																											
<b>Note: Codes marked with an asterisk (*) must be enabled with Code 3 prior to configuration.</b>																													
0	<b>Operating mode</b> [MAN] Manual mode AUTO Automatic mode SAFE Fail-safe position ESC Stop	Switchover from automatic to manual mode is bumpless. In fail-safe position, the S icon is displayed. In MAN and AUTO mode, the system deviation is represented by the bar graph elements. The reading indicates the valve position or angle of rotation in % when the positioner is initialized. If the positioner is not initialized, the position of the lever in relation to the longitudinal axis is displayed in degrees (°).																											
1	<b>Manual w</b> [0] to 100 % of the nominal range	Adjust the manual set point with the rotary pushbutton. The current travel/angle is displayed in % when the positioner is initialized. If the positioner is not initialized, the position of the lever in relation to the longitudinal axis is indicated in degrees (°). <b>Note:</b> can only be selected when Code 0 = MAN																											
2	<b>Reading direction</b> 1234, ↻, ESC	The reading direction of the display is turned by 180°.																											
3	<b>Enable configuration</b> [No], YES, ESC	Enables changing of data (automatically deactivated when the rotary pushbutton has not been operated for 120 s).																											
4*	<b>Pin position</b> [No], 17, 25, 35, 50, 70, 100, 200, 300 mm, 90° with rotary actuators, ESC <b>Note:</b> If you select a pin position in Code 4 that is too small, the positioner switches to SAFE mode for reasons of safety.	Follower pin must be mounted in the proper position depending on the valve travel/opening angle. Pin position must be entered for nominal (NOM) or substitute (SUB) initialization. <table border="1" style="margin-left: auto; margin-right: auto;"> <thead> <tr> <th>Pin position Code 4</th> <th>Standard Code 5</th> <th>Adjustment range Code 5</th> </tr> </thead> <tbody> <tr> <td>17</td> <td>7.5</td> <td>3.6 to 17.7</td> </tr> <tr> <td>25</td> <td>7.5</td> <td>5.0 to 25.0</td> </tr> <tr> <td>35</td> <td>15.0</td> <td>7.0 to 35.4</td> </tr> <tr> <td>50</td> <td>30.0</td> <td>10.0 to 50.0</td> </tr> <tr> <td>70</td> <td>40.0</td> <td>14.0 to 70.7</td> </tr> <tr> <td>100</td> <td>60.0</td> <td>20.0 to 100.0</td> </tr> <tr> <td>200</td> <td>120.0</td> <td>40.0 to 200.0</td> </tr> <tr> <td>90°</td> <td>90.0</td> <td>24.0 to 100.0</td> </tr> </tbody> </table>	Pin position Code 4	Standard Code 5	Adjustment range Code 5	17	7.5	3.6 to 17.7	25	7.5	5.0 to 25.0	35	15.0	7.0 to 35.4	50	30.0	10.0 to 50.0	70	40.0	14.0 to 70.7	100	60.0	20.0 to 100.0	200	120.0	40.0 to 200.0	90°	90.0	24.0 to 100.0
Pin position Code 4	Standard Code 5	Adjustment range Code 5																											
17	7.5	3.6 to 17.7																											
25	7.5	5.0 to 25.0																											
35	15.0	7.0 to 35.4																											
50	30.0	10.0 to 50.0																											
70	40.0	14.0 to 70.7																											
100	60.0	20.0 to 100.0																											
200	120.0	40.0 to 200.0																											
90°	90.0	24.0 to 100.0																											

Code no.	Parameter – Readings/values [default setting]	Description
5*	<b>Nominal range</b> mm or angle °, ESC	Nominal valve travel or opening angle must be entered for nominal (NOM) or substitute (SUB) initialization. The possible adjustment range depends on the pin position from the table for Code 4. Indicates maximum travel/angle reached during initialization after initialization has been successfully completed.
6*	<b>Init mode</b> [MAX] Maximum range NOM Nominal range MAN Manual setting SUB Emergency mode ZP Zero calibration ESC Stop	Select the initialization mode MAX: Travel/angle of the closure member from the CLOSED position to the opposite stop in the actuator. NOM: Travel/angle of the closure member measured from the CLOSED position to the indicated OPEN position. MAN: Manually selected range Sub: Substitute calibration (without initialization)
7*	<b>w/x</b> [↗] Increasing/increasing ↘ Increasing/decreasing ESC	Direction of action of the set point w in relation to the travel/angle x Automatic adaptation: AIR TO On completing initialization, the direction of action remains increasing/increasing (↗). A globe valve opens as the set point increases. OPEN: AIR TO On completing initialization, the direction of action CLOSE: changes to increasing/decreasing (↘). A globe valve closes as the set point increases.
8*	<b>Travel/angle range start (lower x-range value)</b> [0.0] to 80.0 % of the nominal range, ESC <b>Note:</b> Specified in mm or angle ° provided Code 4 is activated.	Lower range value for travel/angle in nominal or operating range The <b>operating range</b> is the actual travel/angle of the valve and is limited by the lower travel/angle range value (Code 8) and the upper travel/angle range value (Code 9). Usually, the operating range and the nominal range are identical. The nominal range can be limited to the operating range by the lower and upper x-range values. The value is displayed or must be entered. The characteristic is adapted. See also the example in Code 9.

Code no.	Parameter – Readings/ values [default setting]	Description
9*	<p><b>Travel/angle range end (upper x-range value)</b> 20.0 to [100.0 %] of the nominal range, ESC</p> <p><i>Note: Specified in mm or angle ° provided Code 4 is activated.</i></p>	<p>Upper range value for travel/angle in nominal or operating range The value is displayed or must be entered. The characteristic is adapted.</p> <p><b>Example:</b> The operating range is modified, for example to limit the range of a control valve which has been sized too large. For this function, the entire resolution range of the set point is converted to the new limits. 0 % on the display corresponds to the adjusted lower limit and 100 % to the adjusted upper limit.</p>
10*	<p><b>Travel/angle lower limit (lower x-limit)</b> 0.0 to 49.9 % of the operating range, [No], ESC</p>	<p>Limits travel/opening angle to the entered value (lower limit). The characteristic is not adapted.</p> <p>The characteristic is not adapted to the reduced range. See also the example in Code 11.</p>
11*	<p><b>Travel/angle upper limit (upper x-limit)</b> 50.0 to 120.0 %, [100.0 %] of the operating range, No, ESC</p>	<p>Limits travel/angle to the entered value (upper limit). The characteristic is not adapted.</p> <p><b>Example:</b> In some applications, it is better to limit the valve travel, e.g. if a certain minimum medium flow is required or a maximum flow must not be reached.</p> <p>The lower limit must be adjusted with Code 10 and the upper limit with Code 11.</p> <p>If a tight-closing function has been set up, it has priority over the travel limitation.</p> <p>When set to No, the valve can be opened past the nominal travel with a set point outside of the 0 to 100 % range.</p>
12*	<p><b>w-start</b> [0.0] to 75.0 % of the set point range, ESC</p>	<p>The lower set point range value must be lower than upper range value (w-end), 0 % = 4 mA.</p> <p>The set point range is the difference between w-end and w-start and must be <math>\Delta w \geq 25 \% = 4 \text{ mA}</math>.</p> <p>When the set point range of 0 to 100 % = 4 to 20 mA, the valve must move through its entire operating range from 0 to 100 % travel/angle of rotation.</p> <p>In split-range operation, the valves operate with smaller set points. The control signal of the control unit to control two valves is divided such, for instance, that the valves move through their full travel/angle of rotation at only half the input signal (first valve set to 0 to 50 % = 4 to 12 mA and second valve set to 50 to 100 % = 12 to 20 mA).</p>

Code no.	Parameter – Readings/ values [default setting]	Description
13*	<b>w-end</b> 25.0 to [100.0 %] of the set point range, ESC	The upper range value of the set point range must be greater than lower range value (w-start). 100.0 % = 20 mA
14*	<b>Set point cutoff decrease</b> 0.0 to 49.9 %, [1.0 %] of the span adjusted in Code 12/13, No, ESC	If the set point w reaches up to the entered percentage at the final value that causes the valve to close, the actuator is immediately completely vented (with AIR TO OPEN) or filled with air (with AIR TO CLOSE). This action always lead to maximum tight-closing of the valve. Codes 14/15 have priority over Codes 8/9/10/11. Codes 21/22 have priority over Codes 14/15.
15*	<b>Set point cutoff increase</b> 50.0 to 100.0 % of the span adjusted in Code 12/13, [No], ESC	If the set point w reaches up to the entered percentage at the final value that causes the valve to open, the actuator is immediately filled with air (with AIR TO OPEN) or completely vented (with AIR TO CLOSE). This action always lead to the valve being completely opened. Codes 14/15 have priority over Codes 8/9/10/11. Codes 21/22 have priority over Codes 14/15. <b>Example:</b> set the cutoff to 99 % for three-way valves.
16*	<b>Pressure limit</b> 1.4 bar, 2.4 bar, 3.7 bar, [No], ESC	The signal pressure to the actuator can be limited in stages. After changing a pressure limit already set, the actuator must be vented once (e.g. by selecting the fail-safe position (SAFE) over Code 0). <b>NOTICE</b> <i>Do not activate pressure limitation for double-acting actuators (with fail-safe position AIR TO OPEN).</i>
17*	<b>Proportional-action coefficient <math>K_p</math> (level)</b> 0 to 17, [7], ESC	Read or change $K_p$ <b>Note concerning changing the <math>K_p</math> and <math>T_V</math> levels:</b> During positioner initialization, the values for $K_p$ and $T_V$ are optimally set. If the positioner tends to overshoot impermissibly due to other disturbances, the $K_p$ and $T_V$ levels can be adapted accordingly after initialization. Increment $T_V$ level until desired behavior is reached or when the maximum value of 4 is reached, the $K_p$ level can be decreased in increments. <b>NOTICE</b> $K_p$ level changes affect the set point deviation.

Code no.	Parameter – Readings/ values [default setting]	Description
18*	<b>Derivative-action time <math>T_V</math> (level)</b> 1, [2], 3, 4, No, ESC	Read or change $T_V$ (see $K_p$ level) A change of the $T_V$ level has no effect on the system deviation.
19*	<b>Tolerance band</b> 0.1 to 10.0 %, [5.0 %] of the operating range, ESC	Used for error monitoring. Determination of the tolerance band in relation to the operating range. Associated lag time (30 s) is a reset criterion. If a transit time is determined during initialization which is six times longer than 30 s, the six-fold transit time is accepted as the lag time.
20*	<b>Characteristic</b> [0] to 9, ESC	Select characteristic 0 Linear 1 Equal percentage 2 Reverse equal percentage 3 SAMSON butterfly valve, linear 4 SAMSON butterfly valve, equal percentage 5 VETEC rotary plug valve, linear 6 VETEC rotary plug valve, equal percentage 7 Segmented ball valve, linear 8 Segmented ball valve, equal percentage 9 User-defined (defined over operator software)  <b>i Note</b> <i>The various characteristics are listed in the Appendix (section 11.5).</i>
21*	<b>Required transit time OPEN (w ramp open)</b> [0] to 240 s, ESC	Time required to move through the operating range when the valve opens. Limitation of the transit time (Code 21 and 22): For some applications it is recommendable to limit the transit time of the actuator to prevent it from engaging too fast in the running process. Code 21 has priority over Code 15.  <b>⚠ NOTICE</b> <i>The function is not activated when the fail-safe function or solenoid valve is triggered nor upon failure of the auxiliary power.</i>
22*	<b>Required transit time CLOSED (w ramp closed)</b> [0] to 240 s, ESC	Time required to move through the operating range when the valve closes. Code 22 has priority over Code 14.  <b>⚠ NOTICE</b> <i>The function is not activated when the fail-safe function or solenoid valve is triggered nor upon failure of the auxiliary power.</i>

Code no.	Parameter – Readings/ values [default setting]	Description
23*	<b>Total valve travel</b> [0] to $99 \cdot 10^7$ , RES, ESC Exponential reading from 9999 travel cycles onwards	Totaled full valve travel cycle Can be reset to 0 in Code 36 – Std. <b>Note</b> <i>The total valve travel is saved in a non-volatile memory after every 1000 full valve travel cycle.</i>
24*	<b>LV total valve travel</b> 1000 to $99 \cdot 10^7$ [1.000000], ESC Exponential reading from 9999 travel cycles onwards	Limit value of total valve travel. If the limit is exceeded, the  and  icons are indicated.
25*	<b>Alarm mode</b> 0 to 3, [2], ESC	Switching mode of software limit switch alarms A1 and A2 when activated (when the positioner is initialized). 1) Explosion-protected version according to EN 60947-5-6 0: A1 $\geq 2.2$ mA                      A2 $\leq 1.0$ mA 1: A1 $\leq 1.0$ mA                      A2 $\leq 1.0$ mA 2: A1 $\geq 2.2$ mA                      A2 $\geq 2.2$ mA 3: A1 $\leq 1.0$ mA                      A2 $\geq 2.2$ mA 2) Version without explosion protection 0: A1 R = 348 $\Omega$ A2 Non-conducting 1: A1 Non-conducting                      A2 Non-conducting 2: A1 R = 348 $\Omega$ A2 R = 348 $\Omega$ 3: A1 Non-conducting                      A2 R = 348 $\Omega$ When a positioner has not been initialized, the software limit switches always register the signal as in the state of no response. If there is no mA signal at the terminals 11/12, the software limit switches both switch to $\leq 1.0$ mA (Ex) or non-conducting (without explosion protection). <b>Note</b> <i>Note: The fault alarm output always switches to <math>\leq 1.0</math> mA/non-conducting in case of a fault; it has <math>\geq 2.2</math> mA/R = 348 <math>\Omega</math> when there is no fault.</i>

Code no.	Parameter – Readings/ values [default setting]	Description
26*	<b>Limit A1</b> 0.0 to 100.0 %, [2.0 %] of the operating range, No, ESC	Alarm A1 responds when the value falls below the limit. Software limit value A1 is displayed or can be changed in relation to the operating range. The setting has no effect when an inductive limit switch is installed.
27*	<b>Limit A2</b> 0.0 to 100.0 %, [98.0 %] of the operating range, No, ESC	Alarm A2 responds when the value exceeds the limit. Software limit value A2 is displayed or can be changed in relation to the operating range.
28*	<b>Alarm test</b> Reading direction: Standard      Turned [No]            [No] RUN 1        1 RUN RUN 2        2 RUN RUN 3        3 RUN ESC            ESC	Testing the software limit switch alarm A1 and A2 as well as the fault alarm contact A3. If the test is activated, the contact is switched five times. RUN 1/1 RUN: software limit switch A1 to $\geq 2.2$ mA RUN 2/2 RUN: software limit switch A2 to $\geq 2.2$ mA RUN 3/3 RUN: fault alarm contact A3 to $\leq 1.0$ mA
29*	<b>Position transmitter x/ix<sup>3)</sup></b> [↗↗], ↗↘, ESC	Operating direction of the position transmitter: it indicates assignment between travel/angle position and output signal i based on CLOSED position. The operating range (see Code 8) of the valve is represented by the 4 to 20 mA signal. Values exceeding or falling below the limits 2.4 and 21.6 mA can be indicated. When the positioner has not been mounted (set point smaller than 3.6 mA), the signal is 0.9 mA and 3.8 mA the positioner has not been initialized. When YES is set in Code 32, the position transmitter issues the value as per Code 30 during initialization or zero calibration. When 'No' is set in Code 32, 4 mA is issued during a running calibration.
30*	<b>Fault alarm ix<sup>3)</sup></b> HI, LO, [No], ESC	Select if and how faults that cause the fault alarm contact to be switched are also indicated at the position transmitter output. HI ix = $21.6 \pm 0.1$ mA or LO ix = $2.4 \pm 0.1$ mA



Code no.	Parameter – Readings/values [default setting]	Description
31*	<b>Position transmitter test</b> <sup>3)</sup> -10.0 to 110.0 % of the operating range, [default value is last indicated value of the position transmitter], ESC	Testing the position transmitter. Values can be entered in relation to the operating range. The momentary valve position is used in initialized positioners locally as the start value (bumpless changeover to the test mode). When testing by software, the entered simulation value is issued as the position feedback signal for 30 seconds.
<sup>3)</sup> Analog position transmitter: Code 29/30/31 can only be selected if the position transmitter (optional) is installed.		
32*	<b>Error message in case of 'Function check' condensed state</b> [YES], No, ESC	YES: Error message also in case of 'Function check' condensed state No: 'Function check' condensed state does not cause an error message to be issued  <b>i Note</b> <i>Regardless of the condensed state, the fault alarm output always switches when the error codes 57, 58, 60, 62 and 64 to 70, 76 are issued.</i>
33*	<b>Error message in case of condensed state 'Maintenance required'</b> [YES], No, ESC	YES: Error message only in case of condensed state 'Maintenance alarm' and 'Maintenance required' No: Error message only in case of condensed state 'Maintenance alarm'  <b>i Note</b> <i>Regardless of the condensed state, the fault alarm output always switches when the error codes 57, 58, 60, 62 and 64 to 70, 76 are issued.</i>
34*	<b>Closing direction</b> CL, [CCL], ESC	CL: Clockwise CCL: Counterclockwise Direction of rotation to reach the valve's CLOSED position (view onto rotary switch with positioner cover open). Needs only be entered in SUB initialization mode (Code 6).
35*	<b>Blocking position</b> [0.0] mm/° /%, ESC	Enter the blocking position (distance to CLOSED position) Only necessary with SUB initialization mode.

Code no.	Parameter – Readings/ values [default setting]	Description
36*	<b>Reset</b> [No], Std, diAG, ESC	Std: Resets all parameters and diagnosis data to their default settings. After a reset, the positioner must be re-initialized.  diAG: Resets diagnosis data only. Plotted reference graphs and logs remain saved. The positioner does not need to be re-initialized.
37*	<b>Position transmitter</b> No, YES	Read only Indicates whether an optional position transmitter is installed.
38*	<b>Inductive alarm</b> [No], YES, ESC	Indicates whether the inductive limit switch option is installed or not.
39	<b>Set point deviation e info</b> -99.9 to 99.9 %	Read only Indicates the deviation from the target position ( $e = w - x$ ).
40	<b>Transit time Open info</b> [0] to 240 s	Read only Minimum opening time determined during initialization.
41	<b>Transit time Closed info</b> [0] to 240 s	Read only Minimum closing time determined during initialization.
42	<b>Auto-w info</b> 0.0 to 100.0 % of the span	Read only Indicates the applied automatic set point with corresponding 4 to 20 mA signal.
43	<b>Firmware info</b>	Read only Indicates the positioner type and current firmware version in alternating sequence.
44	<b>y info</b> [0] to 100 %, OP, MAX, - - -	Read only Indicates the control signal y in % in relation to the travel range determined during initialization. MAX: The positioner builds up its maximum output pressure, see description in Code 14 and 15. OP: The positioner vents completely, see description in Code 14 and 15. - - -: The positioner is not initialized.

Code no.	Parameter – Readings/values [default setting]	Description
45	<b>Solenoid valve info</b> YES, HIGH/LOW, No	Read only Indicates whether a solenoid valve is installed or not. If a voltage supply is connected at the terminals of the installed solenoid valve, YES and HIGH appear on the display in alternating sequence. If a voltage supply is not connected (actuator vented, fail-safe position indicated on the display by the S icon), YES and LOW appear on the display in alternating sequence.
48* 49*	<b>Diagnostic parameters ▶ EB 8389</b>	

## 11.4 Error codes

### Initialization errors

Error codes – Recommended action	
	Condensed state message active, when prompted, <b>Err</b> appears. When fault alarms exist, they are displayed here.
50	<b>x &gt; permissible range</b>
	Value of measuring signal too high or too low; the lever operates near its mechanical stops. <ul style="list-style-type: none"> <li>• Pin not mounted properly</li> <li>• Bracket slipped in case of NAMUR attachment or positioner is off center.</li> <li>• Follower plate not mounted properly.</li> </ul>
	Status classification [Maintenance required]
	Recommended action Check attachment and pin position, set operating mode from SAFE to MAN and re-initialize the positioner.
51	<b><math>\Delta x</math> &lt; permissible range</b>
	Insufficient measuring span of the lever. <ul style="list-style-type: none"> <li>• Pin not mounted properly</li> <li>• Wrong lever</li> </ul> An angle of rotation smaller than $16^\circ$ at the positioner shaft only generates an alarm. An angle below $9^\circ$ leads to the initialization being canceled.
	Status classification [Maintenance required]
	Recommended action Check attachment and re-initialize the positioner.

Error codes – Recommended action		Condensed state message active, when prompted, <b>Err</b> appears. When fault alarms exist, they are displayed here.
52	<b>Attachment</b>	<ul style="list-style-type: none"> <li>Invalid positioner attachment</li> <li>Nominal travel/angle (Code 5) could not be achieved during NOM initialization (no tolerance downwards permissible).</li> <li>Mechanical or pneumatic fault, e.g. wrong lever selected or supply pressure too low to move to the required position.</li> </ul>
	Status classification	[Maintenance required]
	Recommended action	Check attachment and supply pressure. Re-initialize the positioner. Under certain circumstances, it may be possible to check the maximum travel/angle by entering the actual pin position and then performing a MAX initialization. After initialization has been completed, the Code 5 indicates the maximum achieved travel or angle.
53	<b>Initialization time exceeded (Init time &gt;)</b>	Initialization takes too long. The positioner returns to the previous operating mode. <ul style="list-style-type: none"> <li>No pressure in supply line or pneumatic leakage</li> <li>Supply air failure during initialization</li> </ul>
	Status classification	[Maintenance required]
	Recommended action	Check attachment and supply air line. Re-initialize the positioner.
54	<b>Initialization – solenoid valve</b>	<ol style="list-style-type: none"> <li>A solenoid valve is installed (Code 45 = YES) and has not been connected or not properly. As a result, actuator pressure cannot build up. The alarm is generated when you attempt to initialize the positioner.</li> <li>If you attempt to initialize the positioner from the fail-safe position (SAFE).</li> </ol>
	Status classification	[Maintenance required]
	Recommended action	<ol style="list-style-type: none"> <li>Check connection and supply voltage of the solenoid valve (Code 45 High/Low).</li> <li>Set the MAN mode in Code 0. Re-initialize the positioner.</li> </ol>
55	<b>Transit time too short (transit time &lt;)</b>	Actuator transit times detected during initialization are so short that optimal positioner tuning is impossible.
	Status classification	[Maintenance required]
	Recommended action	Check the volume restriction setting as described in section 7.2. Re-initialize the positioner.

<b>Error codes – Recommended action</b>		Condensed state message active, when prompted, <b>Err</b> appears. When fault alarms exist, they are displayed here.
<b>56</b>	<b>Pin position</b>	Initialization canceled because selected NOM and SUB initialization modes require the pin position to be entered.
	Status classification	[Maintenance required]
	Recommended action	Enter pin position over Code 4 and nominal travel/angle over Code 5. Re-initialize the positioner.

## Operational errors

<b>Error codes – Recommended action</b>		Condensed state message active, when prompted, <b>Err</b> appears. When fault alarms exist, they are displayed here.
<b>57</b>	<b>Control loop</b> Additional indication at the fault alarm contact	Control loop error, the valve no longer follows the controlled variable within tolerable times (tolerance band alarm Code 19). <ul style="list-style-type: none"> <li>• Actuator blocked</li> <li>• Positioner attachment shifted subsequently</li> <li>• Supply pressure no longer suffices.</li> </ul>
	Status classification	[Maintenance required]
	Recommended action	Check attachment.
<b>58</b>	<b>Zero point</b>	Zero point incorrect Error can occur when the positioner's attachment position is shifted or when the valve trim is worn, particularly with soft-sealed plugs.
	Status classification	[Maintenance required]
	Recommended action	Check valve and attachment of the positioner. If OK, perform a zero calibration over Code 6 (see section 7.7). We recommend to re-initialize the positioner if zero deviates by more than 5%.
<b>59</b>	<b>Auto-correction</b>	Errors in the positioner's data section are detected detected by automatic monitoring and corrected automatically.
	Status classification	[No message]
	Recommended action	Automatic
<b>60</b>	<b>Fatal error</b> Additional indication at the fault alarm contact	Error in safety-relevant data that cannot be corrected automatically. Possible cause: EMC disturbances. The valve is moved to fail-safe position.
	Status classification	Maintenance alarm (cannot be classified)
	Recommended action	Reset over Code 36 – Std. Re-initialize the positioner.

## Hardware errors

Error codes – Recommended action		Condensed state message active, when prompted, <i>Err</i> appears. When fault alarms exist, they are displayed here.
62	<b>x signal</b> Additional indication at the fault alarm contact	<p>Actuator's measured value recording failed. The conductive plastic element is defective. The device continues functioning in emergency mode but it must be replaced as quickly as possible. The emergency mode on the display is indicated by a blinking closed-loop operation icon and 4 dashes instead of the position reading.</p> <p><b>Note on the open-loop operation:</b> <i>If the measuring system has failed, the positioner is still in a reliable state. The positioner switches to emergency mode where the position cannot be accurately controlled anymore. However, the positioner continues operation according to its set point so that the process remains in a safe state.</i></p>
	Status classification	[Maintenance demanded]
	Recommended action	Return positioner to SAMSON AG for repair.
63	<b>w too low</b>	<p>The set point is considerably smaller than 4 mA (0 %). This happens when the positioner's power supply does not meet the standard requirements. This state is indicated on the positioner display by <b>LOW</b> blinking.</p>
	Status classification	[No message]
	Recommended action	<p>Check set point. If necessary, adjust the current source's lower limit so that no values lower than 4 mA can be applied.</p>
64	<b>i/p converter (y)</b>	Current circuit of i/p converter interrupted.
	Status classification	Maintenance alarm (cannot be classified)
	Recommended action	Cannot be remedied. Return positioner to SAMSON AG for repair.

## Error appendix

Error codes – Recommended action		Condensed state message active, when prompted, <i>Err</i> appears. When fault alarms exist, they are displayed here.
65	<b>Hardware</b> Additional indication at the fault alarm contact	Initialization key jammed (firmware version R 1.51 and higher) A hardware error has occurred. The positioner changes to the fail-safe position (SAFE).
	Status classification	[Maintenance alarm]
	Recommended action	Confirm error and return to automatic mode or perform a reset and re-initialize the positioner. If this is not successful, return positioner to SAMSON for repair.
66	<b>Data memory</b> Additional indication at the fault alarm contact	No more data can be written to the memory, e.g. because written data deviate from read data. The valve moves to the fail-safe position.
	Status classification	Maintenance alarm (cannot be classified)
	Recommended action	Return positioner to SAMSON AG for repair.
67	<b>Check calculation</b> Additional indication at the fault alarm contact	Hardware controller monitored by test calculation.
	Status classification	[Maintenance alarm]
	Recommended action	Confirm error. If this is not possible, return positioner to SAMSON for repair.

## Data errors

Error codes – Recommended action		Condensed state message active, when prompted, <i>Err</i> appears. When fault alarms exist, they are displayed here.
68	<b>Control parameters</b> Additional indication at the fault alarm contact	Error in control parameters.
	Status classification	[Maintenance required]
	Recommended action	Confirm error, perform a reset and re-initialize the positioner.
69	<b>Potentiometer parameters</b> Additional indication at the fault alarm contact	Error in digital potentiometer parameters
	Status classification	[Maintenance required]
	Recommended action	Confirm error, perform a reset and re-initialize the positioner.
70	<b>Calibration</b> Additional indication at the fault alarm contact	Error in data from production calibration. The positioner continues operation with cold start values.
	Status classification	[Maintenance required]
	Recommended action	Return positioner to SAMSON AG for repair.
71	<b>General parameters</b>	Error in parameters not critical to control operation.
	Status classification	[Maintenance required]
	Recommended action	Confirm error. Check and, if necessary, change the settings of the required parameters.
73	<b>Internal device error 1</b>	Internal device error
	Status classification	[Maintenance required]
	Recommended action	Return positioner to SAMSON AG for repair.
75	<b>Info parameters</b>	Error in information parameters not critical to closed-loop control operation.
	Status classification	[Maintenance required]
	Recommended action	Confirm error. Check and, if necessary, change the settings of the required parameters.



Error codes – Recommended action		Condensed state message active, when prompted, <b>Err</b> appears. When fault alarms exist, they are displayed here.
76	<b>No emergency mode</b>	The travel measuring system of the positioner has a self-monitoring function (see Code 62). An emergency mode (open-loop control) is not available for certain actuators, such as double-acting actuators. In case of a travel sensing error, the positioner vents the output (Output 38) or A1 in double-acting actuators. During the initialization, the positioner automatically checks whether the actuator has such a function or not.
	Status classification	[No message]
	Recommended action	Merely information, confirm, if necessary. No further action required.
77	<b>Software loading error</b>	When the positioner starts operation for the first time after the PA signal has been applied, it carries out a self-test ( <b>IEStinG</b> runs across the display). If the positioner loads the wrong software, the valve moves to the fail-safe position. It is not possible to make the valve leave this fail-safe position again.
	Status classification	Maintenance alarm (cannot be classified)
	Recommended action	Interrupt current signal and restart the positioner. If not successful, return positioner to SAMSON for repair.
78	<b>Option parameters</b>	Error in option parameters.
	Status classification	[Maintenance required]
	Recommended action	Return positioner to SAMSON AG for repair.

## Diagnosis errors

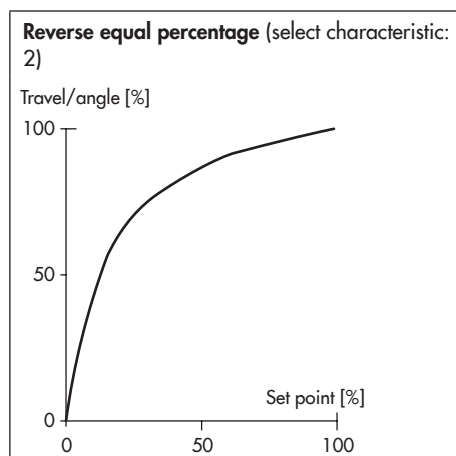
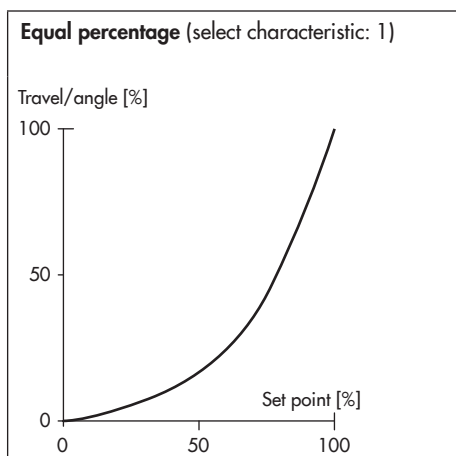
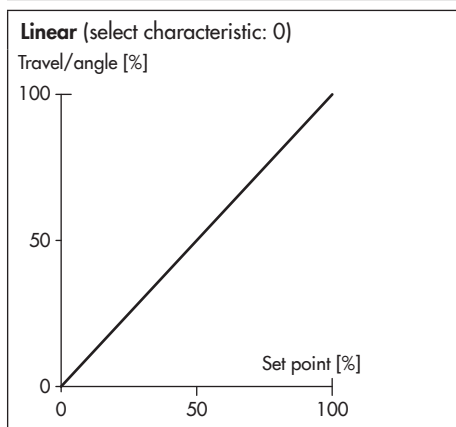
<b>Error codes – Recommended action</b>		Condensed state message active, when prompted, <b>Err</b> appears. When fault alarms exist, they are displayed here.
<b>79</b>	<b>Diagnostic messages</b>	Messages generated by the extended diagnostics
	Status classification	Maintenance required (cannot be classified)
<b>80</b>	<b>Diagnostic parameters</b>	Error in parameters not critical to control operation.
	Status classification	Maintenance required (cannot be classified)
	Recommended action	Confirm error. Check and, if necessary, perform a new reference test.
<b>81</b>	<b>Reference graphs</b>	<p>Error occurred during plotting the reference graphs for drive signal y steady-state or drive signal y hysteresis.</p> <ul style="list-style-type: none"> <li>• Reference test canceled</li> <li>• Reference line for drive signal y steady-state or drive signal y hysteresis was not adopted.</li> </ul> <p>Error messages are not yet saved in a non-volatile memory. They cannot be reset.</p>
	Status classification	[No message]
	Recommended action	Check and, if necessary, perform a new reference test.

## 11.5 Selecting the characteristic

The characteristics that can be selected in Code 20 are shown in the following in graph form.

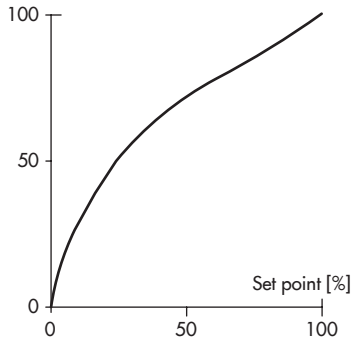
### **i** Note

A characteristic can only be defined (user-defined characteristic) using a workstation/operating software (e.g. TROVIS-VIEW).



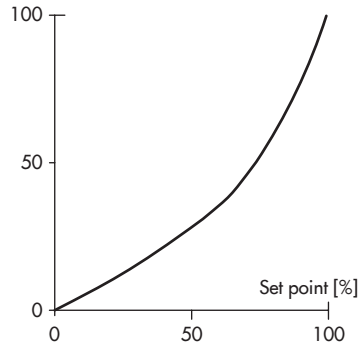
**SAMSON butterfly valve linear** (select characteristic: 3)

Travel/angle [%]



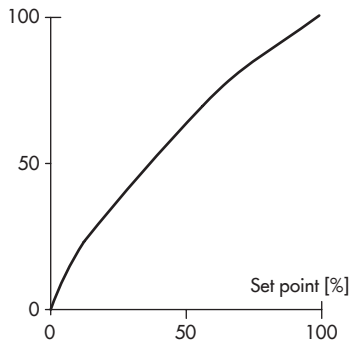
**SAMSON butterfly valve equal percentage** (select characteristic: 4)

Travel/angle [%]



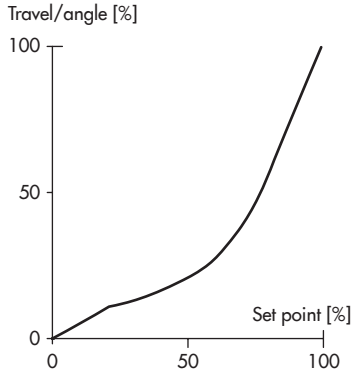
**VETEC rotary plug valve linear** (select characteristic: 5)

Travel/angle [%]



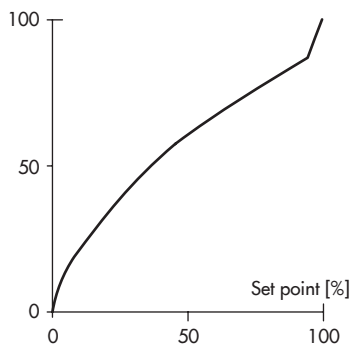
**VETEC rotary plug valve equal percentage** (select characteristic: 6)

Travel/angle [%]



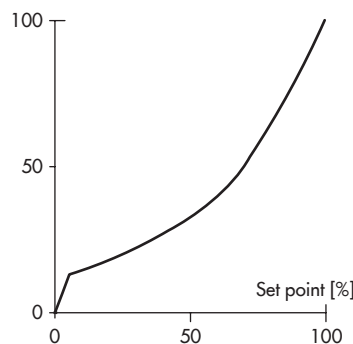
**Segmented valve ball linear** (select characteristic: 7)

Travel/angle [%]



**Segmented valve ball equal percentage** (select characteristic: 8)

Travel/angle [%]





VDE Prüf und Zertifizierungsinstitut

**TRANSLATION**

Offenbach, 2005-11-21

Your ref.  
479000-9010-0001/67325  
FC3384-wa

Your letter  
2005-11-08

Your ref.  
P. Opl

Contact:  
Gerhard Biehl  
Tel. (069) 8396-249  
Tel. (069) 8396-716  
Fax (069) 8396-716  
gerhard.biehl@vde.com

**Test report for Information of the Applicant**

**Testing of the Degree of Protection on enclosures of Type 3730 and Type 3731 Positioners**

This test report contains the result of a single investigation carried out on the product submitted. A sample of this product was tested to find the accordance with the thereafter listed standards resp. parts of standards.

The test report does not entitle to use a VDE Certification mark and the "GS – geprüfte Sicherheit (test safety)" and does not refer to all VDE specifications applicable to the tested product.

This report may only be passed to a third party in its complete wording including this preamble and the date of issue.

Any publication or reproduction requires the prior written approval of the VDE Testing and Certification Institute.

**1 Assignment**

The samples described in 2. below were tested for compliance with the IP 66 degree of protection.

**2 Samples**

- 2.1 Type 3730 Positioner
- 2.2 Type 3731 Positioner

VDE VERBAND DER ELEKTROTECHNIK  
ELEKTRONIK INFORMATIONSTECHNIK e.V.  
Postfach 1015 53  
Postfach 1015 • D-63089 Frankfurt am Main  
Tel. +49 (0)69 6529 19-11  
Telefax +49 (0)69 6529 19-20  
E-Mail: [info@vde.com](mailto:info@vde.com)  
Internet: [www.vde.com](http://www.vde.com)

Testing and Certification Institute  
Merianstrasse 28  
D-63069 Offenbach



VDE Prüf und Zertifizierungsinstitut

**3 Basis of assessment**

DIN EN 60529/VDE 0470 Part 1:2000-09  
Degree of protection provided by enclosures (IP Code)  
German version EN 60529:1999+A1:2000

**4 Execution of the tests**

The dust test had already been carried out on the Type 3730 Positioner under the reference number: 479000-9010-0001/32752, and on the Type 3731 Positioner under the reference number: 479000-9010-0001/58983 with suction as per category 1 at the connecting enclosures of the positioners and solenoid valves. The under pressure was 2 kPa and the test lasted 8 hours.

**5 Test results**

The testing of the samples described in 2. above yielded the following results:

Protecting against access to hazardous parts and against ingress of solid foreign objects according to  
DIN EN 60529/VDE 0470 Part 1:2000-09

IP6X satisfied

Protecting against ingress of water according to  
DIN EN 60529/VDE 0470 Part 1:2000-09

IPX6 satisfied

The positioner enclosures in the versions submitted meet the requirements of IP 66 degree of protection.

There was no ingress of either dust or water.

VDE- Prüf- und Zertifizierungsinstitut  
Fachgebiet FG33

(Signature)

(Signature)

Gerhard Biehl

VDE VERBAND DER ELEKTROTECHNIK  
ELEKTRONIK INFORMATIONSTECHNIK e.V.  
Postfach 1015 53  
Postfach 1015 • D-63089 Frankfurt am Main  
Tel. +49 (0)69 6529 19-11  
Telefax +49 (0)69 6529 19-20  
E-Mail: [info@vde.com](mailto:info@vde.com)  
Internet: [www.vde.com](http://www.vde.com)

Testing and Certification Institute  
Merianstrasse 28  
D-63069 Offenbach



# IECEX Certificate of Conformity

## INTERNATIONAL ELECTROTECHNICAL COMMISSION IEC Certification Scheme for Explosive Atmospheres

for rules and details of the IECEx Scheme visit [www.iecex.com](http://www.iecex.com)

Certificate No.: **IECEX PTB 05.0007** Issue No.: **0**

Status: **Current**

Date of Issue: **2005-02-21** Page 1 of 3

Applicant: **SAMSON AG Mess- und Regeltechnik  
Weismuellerstrasse 3  
D-60314 Frankfurt am Main  
Germany**

Electrical Apparatus: **e/p-positioner type 3730-21..**  
Optional accessory:

Type of Protection: **General Requirements, Intrinsic Safety, Protection by Enclosure**

Marking: **Ex ia IIC T6/T5/T4  
IP 54 and IP 65 T 80 °C**

Approved for issue on behalf of the IECEx  
Certification Body:

Dr.-Ing. Ulrich Johannsmeyer

Position:

Department Head "Intrinsic Safety and Safety of  
Systems

Signature:  
(for printed version)

\_\_\_\_\_

Date:

\_\_\_\_\_

1. This certificate and schedule may only be reproduced in full.
2. This certificate is not transferable and remains the property of the issuing body.
3. The Status and authenticity of this certificate may be verified by visiting the Official IECEx Website.

Certificate issued by:

**Physikalisch-Technische  
Bundesanstalt (PTB)**

Bundesallee 100  
38116 Braunschweig  
Germany





# IECEX Certificate of Conformity

Certificate No.: **IECEX PTB 05.0007**

Date of Issue: **2005-02-21**

Issue No.: **0**

Page 2 of 3

Manufacturer: **SAMSON AG Mess- und Regeltechnik**  
Weismuellerstrasse 3  
D-60314 Frankfurt am Main  
Germany

Manufacturing location(s):

This certificate is issued as verification that a sample(s), representative of production, was assessed and tested and found to comply with the IEC Standard list below and that the manufacture's quality system, relating to the Ex products covered by this certificate, was assessed and found to comply with the IECEx Quality system requirements. This certificate is granted subject to the conditions as set out in IECEx Scheme Rules, IECEx 02 and Operational Documents as amended.

#### STANDARDS:

The electrical apparatus and any acceptable variations to it specified in the schedule of this certificate and the identified documents, was found to comply with the following standards:

<b>IEC 60079-0 : 2000</b> Edition: 3.1	Electrical apparatus for explosive gas atmospheres - Part 0: General requirements
<b>IEC 60079-11 : 1999</b> Edition: 4	Electrical apparatus for explosive gas atmospheres - Part 11: Intrinsic safety "i"
<b>IEC 61241-1-1 : 1999</b> Edition: 2	Electrical apparatus for use in the presence of combustible dust - Part 1-1: Electrical apparatus protected by enclosures and surface temperature limitation - Specification for apparatus

*This Certificate **does not** indicate compliance with electrical safety and performance requirements other than those expressly included in the Standards listed above.*

#### TEST & ASSESSMENT REPORTS:

*A sample(s) of the equipment listed has successfully met the examination and test requirements as recorded in*

IECEX ATR:  
**DE/PTB/05-004**

File Reference:  
**B002158**



# IECEX Certificate of Conformity

Certificate No.: IECEx PTB 05.0007

Date of Issue: 2005-02-21

Issue No.: 0

Page 3 of 3

## Schedule

### EQUIPMENT:

*Equipment and systems covered by this certificate are as follows:*

General description: single- or double-acting positioner for attachment to pneumatic actuators with self-balancing automatic adjustment to valve and actuator. Reference variable: 4 to 20mA, Nominal travels 3.6 to 200 mm; angles of rotation: 24 to 100° Features: Simple attachment to current linear and rotary actuators with interface for SAMSON - direct attachment. NAMUR- rib; attachment to rod-type yoke acc. to IEC 60534-6-1. Any mounting position. Options: Position indicator, software proximity switches, inductive proximity switch, forced venting function, fault alarm output, external displacement transducer and serial interface.

CONDITIONS OF CERTIFICATION: NO

Annexe: 3730-21\_Electrical data.pdf; 3730-21\_Type code.pdf





(1) **EU-TYPE-EXAMINATION CERTIFICATE**  
(Translation)

- (2) Equipment or Protective Systems Intended for Use in Potentially Explosive Atmospheres - **Directive 2014/34/EU**
- (3) EU-Type Examination Certificate Number:

**PTB 00 ATEX 2158**

**Issue: 01**

- (4) Product: e/p-positioner Typ 3730-21 und 3730-25
- (5) Manufacturer: SAMSON AG Mess- und Regeltechnik
- (6) Address: Weismüllerstraße 3, 60314 Frankfurt, Germany
- (7) This product and any acceptable variation thereto is specified in the schedule to this certificate and the documents therein referred to.
- (8) The Physikalisch-Technische Bundesanstalt, notified body No. 0102 in accordance with Article 17 of the Directive 2014/34/EU of the European Parliament and of the Council, dated 26 February 2014, certifies that this product has been found to comply with the Essential Health and Safety Requirements relating to the design and construction of products intended for use in potentially explosive atmospheres, given in Annex II to the Directive.
- The examination and test results are recorded in the confidential Test Report PTB Ex 16-25129.
- (9) Compliance with the Essential Health and Safety Requirements has been assured by compliance with:  
**EN 60079-0:2012/A11:2013 EN 60079-11:2012 EN 60079-31:2014**
- (10) If the sign "X" is placed after the certificate number, it indicates that the product is subject to the Specific Conditions of Use specified in the schedule to this certificate.
- (11) This EU-Type Examination Certificate relates only to the design and construction of the specified product in accordance to the Directive 2014/34/EU. Further requirements of the Directive apply to the manufacturing process and supply of this product. These are not covered by this certificate.
- (12) The marking of the product shall include the following:

 **II 2 G Ex ia IIC T6 Gb and II 2 D Ex ia IIIC T80 °C Db or  
II 2 D Ex tb IIIC T80 °C Db**

Konformitätsbewertungsstelle, Sektor Explosionsschutz

Braunschweig, August 17, 2016

On behalf of PTB:

  
Dr.-Ing. U. Genäch  
Regierungsdirektor



ZSEx001e c

sheet 1/7

EU-Type Examination Certificates without signature and official stamp shall not be valid. The certificates may be circulated only without alteration. Extracts or alterations are subject to approval by the Physikalisch-Technische Bundesanstalt. In case of dispute, the German text shall prevail.

Physikalisch-Technische Bundesanstalt • Bundesallee 100 • 38116 Braunschweig • GERMANY

(13)

## SCHEDULE

(14) **EU-Type Examination Certificate Number PTB 00 ATEX 2158 , Issue: 01**

(15) Description of Product

The e/p-positioner type 3730-21 and 3730-25 is a communication capable, single respectively double operating positioner for the attachment to all common lift or slewing-motion actuators. It is intended to assign the valve position to an actuating signal and it is a passive two-terminal network which may be integrated into all certified intrinsically safe circuits, provided that all permissible maximum values for  $U_i$ ,  $I_i$  and  $P_i$  are not exceeded.

The attachment to pneumatic control valves respectively butterfly valves takes place either directly to the actuator of type series 3277 or by means of a NAMUR-adapter housing to conventional actuators.

Non-combustible media are used as a pneumatic auxiliary power.

In the future the e/p-positioner type 3730-21 and 3730-25 may also be manufactured and operated according to the test documents listed in the test report.

The thermal and electrical maximum values are presented in the following.

For relationship between temperature class and permissible ranges of the ambient temperature, reference is made to the following table:

Gas- or dust group	Temperature class	Permissible range of the ambient temperature
IIC	T6	-40 °C ... 60 °C
	T5	-40 °C ... 70 °C
	T4	-40 °C ... 80 °C
IIIC	-	-40 °C ... 80 °C

The relationship between temperature class, the permissible range of the ambient temperature and the maximum short circuit currents for analyzing units for the type **3730-211 and 3730-251** with limit contact (terminals 41/42) applies according to the following table:

sheet 2/7

EU-Type Examination Certificates without signature and official stamp shall not be valid. The certificates may be circulated only without alteration. Extracts or alterations are subject to approval by the Physikalisch-Technische Bundesanstalt. In case of dispute, the German text shall prevail.

Physikalisch-Technische Bundesanstalt • Bundesallee 100 • 38116 Braunschweig • GERMANY

**SCHEDULE TO EU-TYPE EXAMINATION CERTIFICATE PTB 00 ATEX 2158 , Issue: 01**

Temperature class	Permissible range of the ambient temperature	Maximum short circuit current
T6	-45 °C ... 45 °C	52 mA
T5	-45 °C ... 60 °C	
T4	-45 °C ... 75 °C	
T6	-40 °C ... 60 °C	25 mA
T5	-40 °C ... 80 °C	
T4	-40 °C ... 80 °C	

Electrical data

Type 3730-25

$U_N = 28 \text{ V}$   
 $P_N = 1 \text{ W}$

Type 3730-21

Signal circuit ..... type of protection Intrinsic Safety Ex ia IIC/IIIC  
 (Terminals 11/12) only for connection to a certified intrinsically safe circuit

Maximum values:

$U_i = 28 \text{ V}$   
 $I_i = 115 \text{ mA}$   
 $P_i = 1 \text{ W}$   
 $C_i = 5,3 \text{ nF}$   
 $L_i$  negligibly low

Type 3730-21..1 und 3730-25..1

Position indicator ..... type of protection Intrinsic Safety Ex ia IIC/IIIC  
 (Terminals 31/32) only for connection to a certified intrinsically safe circuit

Maximum values:

$U_i = 28 \text{ V}$   
 $I_i = 115 \text{ mA}$   
 $P_i = 1 \text{ W}$   
 $C_i = 5,3 \text{ nF}$   
 $L_i$  negligibly low

resp.

sheet 3/7

EU-Type Examination Certificates without signature and official stamp shall not be valid. The certificates may be circulated only without alteration. Extracts or alterations are subject to approval by the Physikalisch-Technische Bundesanstalt. In case of dispute, the German text shall prevail.

Physikalisch-Technische Bundesanstalt • Bundesallee 100 • 38116 Braunschweig • GERMANY

**SCHEDULE TO EU-TYPE EXAMINATION CERTIFICATE PTB 00 ATEX 2158 , Issue: 01**

**Type 3730-21....1 und 3730-25....1**

Structure-borne sound sensor.....type of protection Intrinsic Safety Ex ia IIC/IIIC  
 (Terminals 31/32) only for connection to a certified intrinsically safe circuit

Maximum values:

$$U_i = 28 \text{ V}$$

$$I_i = 115 \text{ mA}$$

$$C_i = 5,3 \text{ nF}$$

$L_i$  negligibly low

resp.

**Type 3730-21.....2 und 3730-25.....2**

Binary sensor.....type of protection Intrinsic Safety Ex ia IIC/IIIC  
 (Terminals 31/32) only for connection to a certified intrinsically safe circuit

Maximum values:

$$U_i = 28 \text{ V}$$

$$I_i = 115 \text{ mA}$$

$$C_i = 56,3 \text{ nF}$$

$L_i$  negligibly low

**Type 3730-211 und 3730-251**

Limit contacts, software .....type of protection Intrinsic Safety Ex ia IIC/IIIC  
 (Terminals 41/42, 51/52) only for connection to a certified intrinsically safe circuit

Maximum values:

$$U_i = 20 \text{ V}$$

$$I_i = 60 \text{ mA}$$

$$P_i = 250 \text{ mW}$$

$$C_i = 5,3 \text{ nF}$$

$L_i$  negligibly low

resp.

Limit contact, induktive .....type of protection Intrinsic Safety Ex ia IIC/IIIC  
 (Terminals 41/42) only for connection to a certified intrinsically safe circuit

Maximum values:

$$U_i = 16 \text{ V}$$

$$I_i = 52 \text{ mA}$$

$$P_i = 169 \text{ mW}$$

sheet 4/7

---

EU-Type Examination Certificates without signature and official stamp shall not be valid. The certificates may be circulated only without alteration. Extracts or alterations are subject to approval by the Physikalisch-Technische Bundesanstalt. In case of dispute, the German text shall prevail.

Physikalisch-Technische Bundesanstalt • Bundesallee 100 • 38116 Braunschweig • GERMANY

**SCHEDULE TO EU-TYPE EXAMINATION CERTIFICATE PTB 00 ATEX 2158 , Issue: 01**

$C_i = 60 \text{ nF}$

$L_i = 100 \text{ } \mu\text{H}$

resp.

$U_i = 16 \text{ V}$

$I_i = 25 \text{ mA}$

$P_i = 64 \text{ mW}$

$C_i = 60 \text{ nF}$

$L_i = 100 \text{ } \mu\text{H}$

Forced venting .....type of protection Intrinsic Safety Ex ia IIC/IIIC  
 (Terminals 81/82) only for connection to a certified intrinsically safe circuit

Maximum values:

$U_i = 28 \text{ V}$

$I_i = 115 \text{ mA}$

$C_i = 5,3 \text{ nF}$

$L_i$  negligibly low

Fault signal output .....type of protection Intrinsic Safety Ex ia IIC/IIIC  
 (Terminals 83/84) only for connection to a certified intrinsically safe circuit

Maximum values:

$U_i = 20 \text{ V}$

$I_i = 60 \text{ mA}$

$P_i = 250 \text{ mW}$

$C_i = 5,3 \text{ nF}$

$L_i$  negligibly low

Programming interface .....type of protection Intrinsic Safety Ex ia IIC/IIIC

Maximum values:

$U_o = 6,51 \text{ V}$

$I_o = 57,5 \text{ mA}$

$P_o = 94 \text{ mW}$

Linear characteristic

$C_o = 22 \text{ } \mu\text{F}$

$L_o = 10 \text{ mH}$

resp.

sheet 5/7

---

EU-Type Examination Certificates without signature and official stamp shall not be valid. The certificates may be circulated only without alteration. Extracts or alterations are subject to approval by the Physikalisch-Technische Bundesanstalt. In case of dispute, the German text shall prevail.

Physikalisch-Technische Bundesanstalt • Bundesallee 100 • 38116 Braunschweig • GERMANY



**SCHEDULE TO EU-TYPE EXAMINATION CERTIFICATE PTB 00 ATEX 2158 , Issue: 01**

only for connection to a certified intrinsically safe circuit

Maximum values:

$$U_i = 20 \text{ V}$$

$$I_i = 60 \text{ mA}$$

$$P_i = 250 \text{ mW}$$

$C_i$  negligibly low

$L_i$  negligibly low

When intrinsically safe circuits are interconnected the rules for the interconnection of intrinsically safe circuits shall be observed.

External position sensor.....type of protection Intrinsic Safety Ex ia IIC/IIIC  
(Analog-PCB, pins p9, p10, p11)

Maximum values:

$$U_o = 6,51 \text{ V}$$

$$I_o = 56 \text{ mA}$$

$$P_o = 91 \text{ mW}$$

Linear characteristic

$$C_o = 11,2 \text{ }\mu\text{F}$$

$$L_o = 11,6 \text{ mH}$$

$$C_i = 730 \text{ nF}$$

$$L_i = 370 \text{ }\mu\text{H}$$

Changes:

The changes from the EC-Type Examination Certificate PTB 00 ATEX 2158 (5<sup>th</sup> supplement) concern the increase of the internal capacitance of the inductive limit contact (terminals 41/42) to  $C_i = 60 \text{ nF}$ , the update of the applied standards, the adding of another type notation for dust ignition protection by enclosure, the implementation of dust ignition protection by Intrinsic Safety and the application of alternative gasket material of the enclosure. Except the application of alternative enclosures, no other technical changes were made to the equipment.

sheet 6/7

---

EU-Type Examination Certificates without signature and official stamp shall not be valid. The certificates may be circulated only without alteration. Extracts or alterations are subject to approval by the Physikalisch-Technische Bundesanstalt.  
In case of dispute, the German text shall prevail.

Physikalisch-Technische Bundesanstalt • Bundesallee 100 • 38116 Braunschweig • GERMANY

**SCHEDULE TO EU-TYPE EXAMINATION CERTIFICATE PTB 00 ATEX 2158 , Issue: 01**

- (16) Test Report PTB Ex16-25129
- (17) Specific conditions of use  
none
- (18) Essential health and safety requirements  
Met by compliance with the aforementioned standards.

According to Article 41 of Directive 2014/34/EU, EC-type examination certificates which have been issued according to Directive 94/9/EC prior to the date of coming into force of Directive 2014/34/EU (April 20, 2016) may be considered as if they were issued already in compliance with Directive 2014/34/EU. By permission of the European Commission supplements to such EC-type examination certificates and new issues of such certificates may continue to hold the original certificate number issued before April 20, 2016.

Konformitätsbewertungsstelle, Sektor Explosionsschutz  
On behalf of PTB:

Braunschweig, August 17, 2016

  
Dr.-Ing. U. Gerlach  
Regierungsdirektor



sheet 7/7

---

EU-Type Examination Certificates without signature and official stamp shall not be valid. The certificates may be circulated only without alteration. Extracts or alterations are subject to approval by the Physikalisch-Technische Bundesanstalt. In case of dispute, the German text shall prevail.

Physikalisch-Technische Bundesanstalt • Bundesallee 100 • 38116 Braunschweig • GERMANY



## CONFORMITY STATEMENT (Translation)

(1)

(2) Equipment and Protective Systems Intended for Use in Potentially Explosive Atmospheres - **Directive 2014/34/EU**

(3) Test Certificate Number:

**PTB 03 ATEX 2016 X**

**Issue: 01**

(4) Product:

e/p-positioner type 3730-28

(5) Manufacturer:

SAMSON AG Mess- und Regeltechnik

(6) Address:

Weismüllerstraße 3  
60314 Frankfurt, Germany

(7) This product and any acceptable variation thereto are specified in the schedule to this certificate and the documents therein referred to.

(8) The Physikalisch-Technische Bundesanstalt, notified body No. 0102 in accordance with Article 17 of the Directive 2014/34/EU of the European Parliament and of the Council, dated 26 February 2014, certifies that this product has been found to comply with the Essential Health and Safety Requirements relating to the design and construction of products intended for use in potentially explosive atmospheres, given in Annex II to the Directive.

The examination and test results are recorded in the confidential test report PTB Ex 16-25130.

(9) Compliance with the Essential Health and Safety Requirements has been assured by compliance with:

**EN 60079-0:2012+A11:2013 EN 60079-15:2010 EN 60079-31:2014**

(10) If the sign "X" is placed after the certificate number, it indicates that the product is subject to special conditions for safe use specified in the schedule to this certificate.

(11) This Conformity Statement relates only to the design and construction of the specified product in accordance with Directive 94/9/EC. Further requirements of this Directive apply to the manufacture and supply of this product.

(12) The marking of the product shall include the following:

 **II 3 G Ex nA IIC T6 Gc and II 3 D Ex tc IIIC T80 °C Dc**

Konformitätsbewertungsstelle, Sektor Explosionsschutz  
On behalf of PTB

Braunschweig, August 31, 2016

  
Dr.-Ing. F. Liesche  
Regierungsdirektor



Sheet 1/4

Conformity Statements without signature and official stamp shall not be valid. The certificates may be circulated only without alteration. Extracts or alterations are subject to approval by the Physikalisch-Technische Bundesanstalt. In case of dispute, the German text shall prevail.

Physikalisch-Technische Bundesanstalt • Bundesallee 100 • 38116 Braunschweig • GERMANY



(13)

## SCHEDULE

(14) **CONFORMITY STATEMENT PTB 03 ATEX 2016 X, Ausgabe: 01**

(15) Description of the product

The e/p-positioner type 3730-28 is a communication capable, single respectively double operating positioner for the attachment to all common lift or slewing-motion actuators. It is intended to assign the valve position to an actuating signal and it is a passive two-terminal network.

The attachment to pneumatic control valves respectively butterfly valves takes place either directly to the actuator of type series 3277 or by means of a NAMUR-adaptor housing to conventional actuators.

Non-combustible media are used as a pneumatic auxiliary power.

In the future the e/p-positioner type 3730-28 may also be manufactured and operated according to the test documents listed in the test report.

The thermal and electrical maximum values are presented in the following.

For relationship between temperature class and permissible ranges of the ambient temperature, reference is made to the following table:

Gas- or dust group	Temperature class	Permissible range of the ambient temperature
IIC	T6	-40 °C ... 60 °C
	T5	-40 °C ... 70 °C
	T4	-40 °C ... 80 °C
IIIC	Not applicable	-40 °C ... 80 °C

### Electrical data

Signal circuit.....Nominal signal: (Terminals 11/12)	4 ... 20 mA
Position indicator.....Nominal signal: (Terminals 31/32)	4 ... 20 mA
Sensor connection (Leakage-Sensor).....Capacitance (Terminals 31/32)	max. 1,4 nF
Binary input.....Nominal signal: (Terminals 31/32)	6 ... 30 V DC

Sheet 2/4

Conformity Statements without signature and official stamp shall not be valid. The certificates may be circulated only without alteration. Extracts or alterations are subject to approval by the Physikalisch-Technische Bundesanstalt. In case of dispute, the German text shall prevail.

Physikalisch-Technische Bundesanstalt • Bundesallee 100 • 38116 Braunschweig • GERMANY

**SCHEDULE TO EU-TYPE EXAMINATION CERTIFICATE PTB 03 ATEX 2016 X, Issue: 01**

Limit contact, inductive .....Nominal signal: (Terminals 41/42)	8 V DC, 8 mA
Limit contacts, software .....Nominal signal: (Terminals 41/42, 51/52)	8 V DC, 8 mA
Forced venting .....Nominal signal: (Terminals 81/82)	6 ... 24 V DC
Fault signal output .....Nominal signal: (Terminals 83/84)	8 V DC, 8 mA
Programming plug .....Nominal signal:	max. 10 V DC, 20 mA

Changes:

The changes concern the update of the applied standards, cancelling of type of protection Intrinsic Safety, the application of alternative gasket material of the enclosure and the extension with an enclosure with a window.

No other technical changes were made to the equipment.

(16) Test report PTB Ex 16-25130

(17) Specific conditions of use

A fuse according to IEC 60127-2/II, 250 V F respectively IEC 60127-2/VI, 250 V T with a maximum nominal fuse current of  $I_N \leq 63$  mA shall be connected in series to the signal circuit (terminals 11/12).

The position indicator circuit (terminals 31/32) shall be connected to a fuse according to IEC 60127-2/VI, 250 V T with a maximum nominal fuse current of  $I_N \leq 40$  mA shall be connected in series. This fuse shall be arranged outside of the hazardous area.

A fuse according to IEC 60127-2/II, 250 V F respectively IEC 60127-2/VI, 250 V T with a maximum nominal fuse current of  $I_N \leq 40$  mA shall be connected in series to the program interface adapter in the connection of Vcc.

The program interface adapter shall be arranged outside the hazardous area.

The connection of the wires has to be made in a way that the connection is free of tensile and torsional stress.

Sheet 3/4

Conformity Statements without signature and official stamp shall not be valid. The certificates may be circulated only without alteration. Extracts or alterations are subject to approval by the Physikalisch-Technische Bundesanstalt. In case of dispute, the German text shall prevail.

Physikalisch-Technische Bundesanstalt • Bundesallee 100 • 38116 Braunschweig • GERMANY

**SCHEDULE TO EU-TYPE EXAMINATION CERTIFICATE PTB 03 ATEX 2016 X, Issue: 01**

(18) Essential health and safety requirements

Met by compliance with the aforementioned standards.

According to Article 41 of Directive 2014/34/EU, Conformity Statements which have been issued according to Directive 94/9/EC prior to the date of coming into force of Directive 2014/34/EU (April 20, 2016) may be considered as if they were issued already in compliance with Directive 2014/34/EU. By permission of the European Commission supplements to such Conformity Statements and new issues of such certificates may continue to hold the original certificate number issued before April 20, 2016.

Konformitätsbewertungsstelle, Sektor Explosionsschutz  
On behalf of PTB:

Braunschweig, August 31, 2016

  
  
Dr.-Ing. F. Lieneschke  
Regierungsdirektor

Sheet 4/4

Conformity Statements without signature and official stamp shall not be valid. The certificates may be circulated only without alteration. Extracts or alterations are subject to approval by the Physikalisch-Technische Bundesanstalt. In case of dispute, the German text shall prevail.

Physikalisch-Technische Bundesanstalt • Bundesallee 100 • 38116 Braunschweig • GERMANY

**Installation Manual for apparatus certified by CSA for use in hazardous locations.**

Electrical rating of intrinsically safe apparatus and apparatus for installation in hazardous locations.

**Table 1: Maximum values**

Circuit No.	Control signal	Position Indicator <i>or</i> (Binary Input) <i>or</i> [Leakage detection]	Forced venting function Solenoid valve	Limit switches		Fault signal
				inductive	software	
Circuit No.	1	2	5	3 and 4	3 and 4	6
Terminal No.	11 / 12	31 / 32	81 / 82	41 / 42 and 51 / 52	41 / 42 and 51 / 52	83 / 84
U <sub>i</sub> or V <sub>max</sub>	28 V	28 V	28 V	16 V	20 V	20 V
I <sub>i</sub> or I <sub>max</sub>	115 mA	115mA (100 mA) [100 mA]	115 mA	25/52 mA	60 mA	60 mA
P <sub>i</sub> or P <sub>max</sub>	1 W	1 W	500 mW	64/169 mW	250 mW	250 mW
C <sub>i</sub>	5.3 nF	5.3 nF (56.3 nF) [5.3 nF]	5.3 nF	60 nF	13.4 nF	13.4 nF
L <sub>i</sub>	0 μH	0 μH	0 μH	100 μH	0 μH	0 μH

Circuit	Serial interface BU			External position sensor		
Terminal	Connector			Analog pcb pin p9, p10, p11		
U <sub>i</sub> or V <sub>max</sub>	20 V	U <sub>0</sub> or V <sub>0c</sub>	6.51 V	U <sub>0</sub> or V <sub>0c</sub>	6.51 V	
I <sub>i</sub> or I <sub>max</sub>	60 mA	I <sub>0</sub> or I <sub>sc</sub>	57.5 mA	I <sub>0</sub> or I <sub>sc</sub>	56 mA	
P <sub>i</sub> or P <sub>max</sub>	250 mW	P <sub>0</sub>	94 mW	P <sub>0</sub>	91 mW	
C <sub>i</sub>	0 nF	C <sub>0</sub>	22 μF	C <sub>0</sub>	11.2 μF	C <sub>i</sub> = 730 nF
L <sub>i</sub>	0 μH	L <sub>0</sub>	10 mH	L <sub>0</sub>	11.6 mH	L <sub>i</sub> = 370 μH

Notes: Entity parameters must meet the following requirements:

$$U_0 \text{ or } V_{0c} \text{ or } V_t \leq U_i \text{ or } V_{max} / I_0 \text{ or } I_{sc} \text{ or } I_t \leq I_i \text{ or } I_{max} / P_0 \text{ or } P_{max} \leq P_i \text{ or } P_{max}$$

$$C_a \geq C_i + C_{cable} \text{ and } L_a \geq L_i + L_{cable}$$

**Table 2: CSA/FM – certified barrier parameters of circuit 2 and 5**

Barrier	Supply barrier				Evaluation barrier		
	V <sub>0C</sub>	R <sub>min</sub>	I <sub>SC</sub>	P <sub>max</sub>	V <sub>0C</sub>	R <sub>min</sub>	I <sub>SC</sub>
circuit 2	≤ 28 V	≥ 300 Ω	≤ 115 mA	≤ 1 W	≤ 28 V	#	0 mA
circuit 5	≤ 28 V	≥ 392 Ω	≤ 115 mA	≤ 500 mW	≤ 28 V	#	0 mA

**Table 3: The correlation between temperature classification and permissible ambient temperature ranges is shown in the table below:**

Temperature class	Permissible ambient temperature range
T6	- 40 °C ... 60 °C
T5	- 40 °C ... 70 °C
T4	- 40 °C ... 80 °C

**Table 4: For the Model 3730 – 231 . . . Positioner the correlation between temperature classification, permissible ambient temperature ranges and maximum short- circuit current is shown in the table below:**

Temperature class	Permissible ambient temperature range	Maximum short-circuit current
T6	- 40 °C ... 45 °C	52 mA
T5	- 40 °C ... 60 °C	
T4	- 40 °C ... 75 °C	
T6	- 40 °C ... 60 °C	25 mA
T5	- 40 °C ... 80 °C	
T4	- 40 °C ... 80 °C	

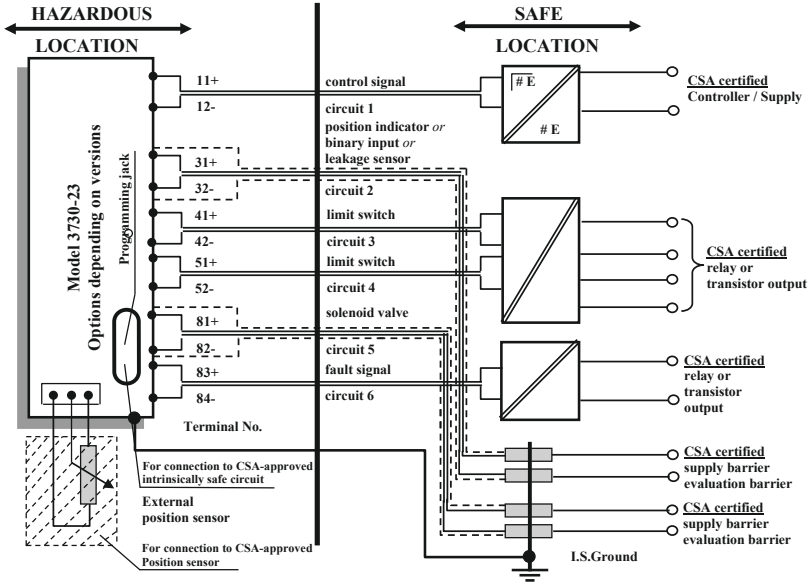
**Intrinsically safe if installed as specified in manufacturer’s installation manual EB 8384-2 EN.  
 CSA- certified for hazardous locations.**

**Ex ia IIC T6: Class I, Zone 0  
 Class I, Div. 1, Groups A, B, C, D.  
 Class II Div. 1, Groups E, F + G; Class III.**

**Type 4 Enclosure**

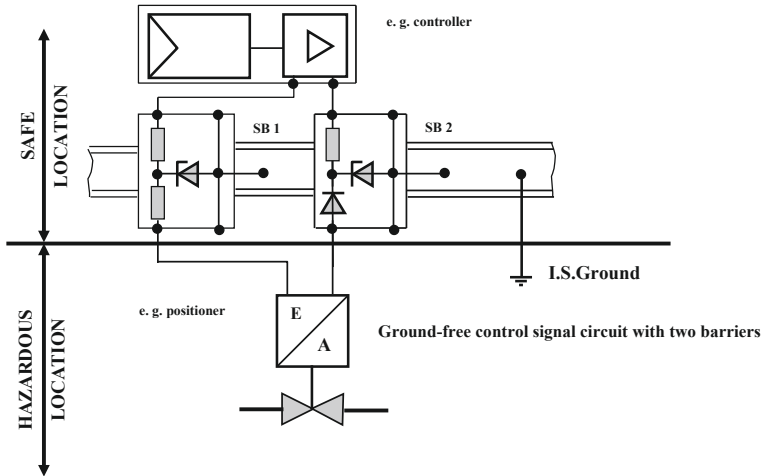
**Notes:**

- 1.) The apparatus may be installed in intrinsically safe circuits only when used in conjunction with CSA certified apparatus. For maximum values of  $U_i$  or  $V_{max}$ ;  $I_i$  or  $I_{max}$ ;  $P_i$  or  $P_{max}$ ;  $C_i$  and  $L_i$  of the various apparatus see Table 1 on page 1.
- 2.) For barrier selection see Table 2 on page 2.
- 3.) The installation must be in accordance with the C. E. C. Part 1.
- 4.) Use only supply wires suitable for 5°C above surrounding temperature.
- 5.) For CSA Certification, Safety Barrier must be CSA Certified and installed in accordance with C.E.C. Part. 1. Each pair of I.S. wires must be protected by a shield that is grounded at the I.S. Ground. The shield must extend as close to the terminals as possible.
- 6.) Substitution of components may impair intrinsic safety.
- 7.) For the permissible maximum values for the intrinsically safe circuits 1,3,4 and 6 see Table 1
- 8.) For the permissible barrier parameters for the circuits 2 and 5 see Table 2
- 9.) Cable entry M 20 x 1.5 or metal conduit according to drawing No. 1050 – 0539 T or 1050 – 0540 T



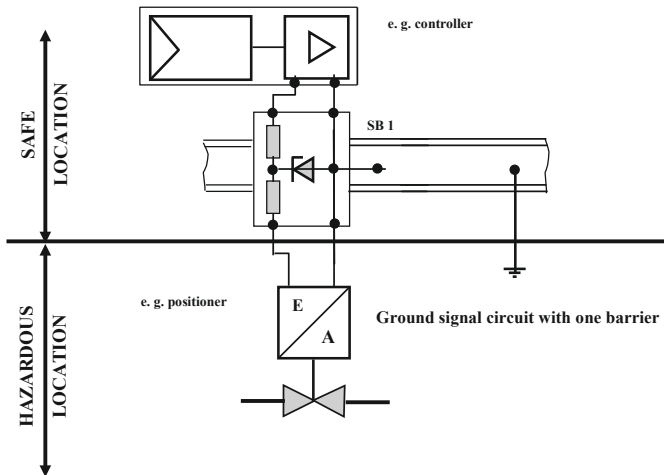
On interconnection to form ground- free signal circuits, only evaluation barriers must be installed in the return line. Correct polarity must be ensured.

**Circuit diagram of a ground- free signal circuit.**  
(position indicator and forced venting function)



In grounded signal circuits with only one barrier, the return line must be grounded or included in the potential equalization network of the system.

**Circuit diagram of a grounded signal circuit**  
(position indicator and forced venting function)



**CSA- certified for hazardous locations**

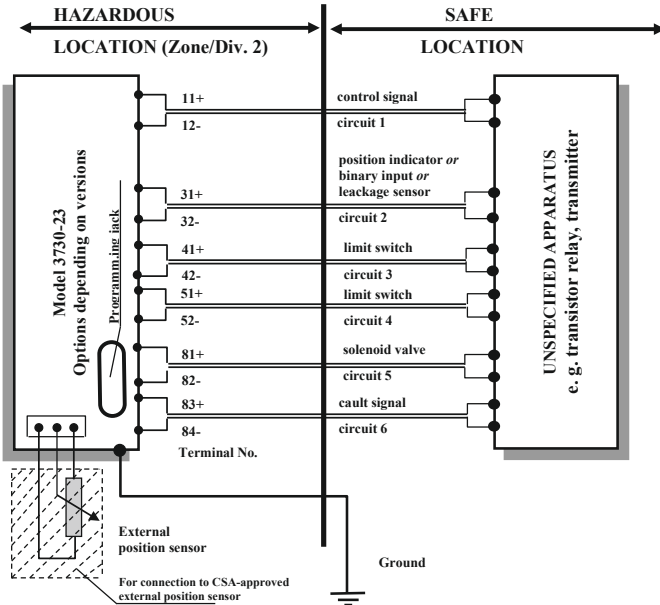
**Class I, Zone 2**

**Class I, Division 2, Groups A, B, C, D,**

**Class II, Groups E, F + G; Class III.**

**Type 4 Enclosure**

e/p - positioner with position indicator, forced venting function (solenoid valve), fault signal and limit switches.

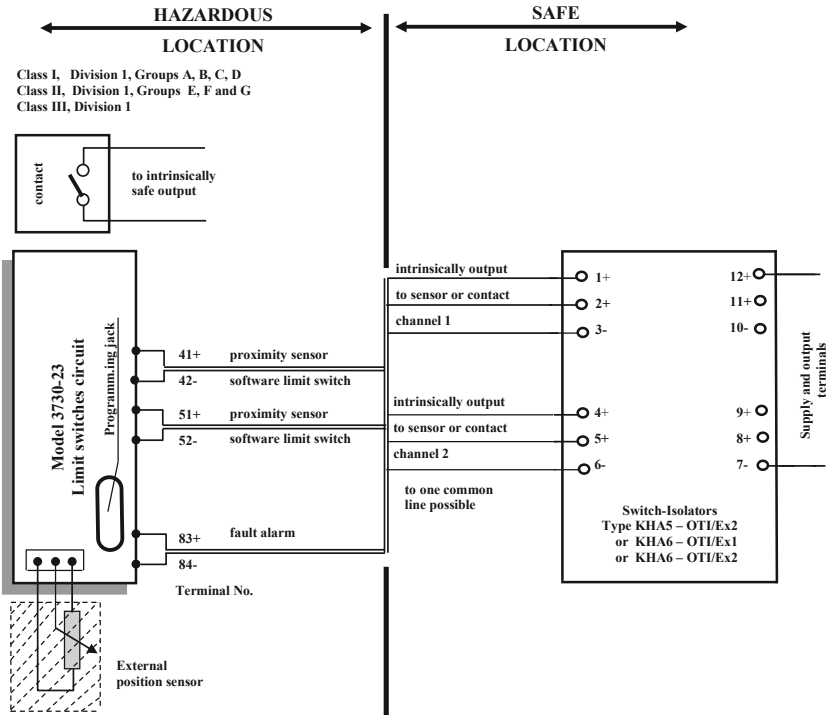


**Notes:**

- 1.) The installation must be in accordance with the Canadian Electrical Code, Part 1
- 2.) For the maximum values for the individual circuits see Table 1 and 2.
- 3.) Cable entry only rigid metal conduit according to drawing No. 1050-0539 T and 1050-0540 T
- 4.) Substitution of components may impair intrinsic safety.



**Installation drawing Control Relay KHA5-OTI/Ex2, KHA6-OTI/Ex1 or KHA6-OTI/Ex2 with Model SJ-b-N Proximity Sensors**



maximum capacitance of each inductive sensor 60 nF  
 maximum inductance of each inductive sensor 200 µH

The total series inductance and shunt capacitance of shield wiring shall be restricted to the following maximum values

Control Relay Terminal No.	Groups	L [ mH ]	C [ µF ]	V0C [ V ]	ISC [ mA ]
1-3; 2-3 4-6; 5-6	A + B	84.8	1.27	↑ 12.9 ↓	↑ 19.8 ↓
	C	299	3.82		
	D	744	10.2		

Each pair of I.S. wires must be protected by a shield that is grounded at the I.S. Ground. The shield must extend as close to the terminals as possible Install per C.E.C. Part 1.

**Installation Manual for apparatus approved by FM for use in hazardous locations.**

Electrical rating of intrinsically safe apparatus and apparatus for installation in hazardous locations.

**Table 1: Maximum values**

	Control signal	Position Indicator <i>or</i> Binary Input <i>or</i> Leakage detection	Forced venting function Solenoid valve	Limit switches		Fault signal
				inductive	software	
<b>Circuit No.</b>	1	2	5	3 and 4	3 and 4	6
<b>Terminal No.</b>	11 / 12	31 / 32	81 / 82	41 / 42 and 51 / 52	41 / 42 and 51 / 52	83 / 84
<b>U<sub>i</sub> or V<sub>max</sub></b>	28 V	28 V	28 V	16 V	20 V	20 V
<b>I<sub>i</sub> or I<sub>max</sub></b>	115 mA	115mA (100 mA) [100 mA]	115 mA	25/52 mA	60 mA	60 mA
<b>P<sub>i</sub> or P<sub>max</sub></b>	1 W	1 W	500 mW	64/169 mW	250 mW	250 mW
<b>C<sub>i</sub></b>	5.3 nF	5.3 nF (56.3 nF) [5.3 nF]	5.3 nF	60 nF	13.4 nF	13.4 nF
<b>L<sub>i</sub></b>	0 μH	0 μH	0 μH	100 μH	0 μH	0 μH

Circuit	Serial interface BU			External position sensor		
Terminal	Connector			Analog pcb. pin p9, p10, p11		
<b>U<sub>i</sub> or V<sub>max</sub></b>	20 V	U <sub>0</sub> or V <sub>0C</sub>	6.51 V	U <sub>0</sub> or V <sub>0C</sub>	6.51 V	
<b>I<sub>i</sub> or I<sub>max</sub></b>	60 mA	I <sub>0</sub> or I <sub>SC</sub>	57.5 mA	I <sub>0</sub> or I <sub>SC</sub>	56 mA	
<b>P<sub>i</sub> or P<sub>max</sub></b>	250 mW	P <sub>0</sub>	94 mW	P <sub>0</sub>	91 mW	
<b>C<sub>i</sub></b>	0 nF	C <sub>0</sub>	22 μF	C <sub>0</sub>	11.2 μF	C <sub>i</sub> = 730 nF
<b>L<sub>i</sub></b>	0 μH	L <sub>0</sub>	10 mH	L <sub>0</sub>	11.6 mH	L <sub>i</sub> = 370 μH

Notes: Entity parameters shall meet the following requirements:

$$U_0 \text{ or } V_{0C} \text{ or } V_t \leq U_i \text{ or } V_{max} / I_0 \text{ or } I_{SC} \text{ or } I_t \leq I_i \text{ or } I_{max} / P_0 \text{ or } P_{max} \leq P_i \text{ or } P_{max}$$

$$C_a \geq C_i + C_{cable} \text{ and } L_a \geq L_i + L_{cable}$$

**Table 2: FM/ CSA – approved barrier parameters of circuit 2 and 5**

Barrier	Supply barrier				Evaluation barrier		
	V <sub>0C</sub>	R <sub>min</sub>	I <sub>SC</sub>	P <sub>max</sub>	V <sub>0C</sub>	R <sub>min</sub>	I <sub>SC</sub>
circuit 2	≤ 28 V	≥ 196 Ω	≤ 115 mA	≤ 1 W	≤ 28 V	#	0 mA
circuit 5	≤ 28 V	≥ 392 Ω	≤ 115 mA	≤ 500 mW	≤ 28 V	#	0 mA

**Table 3: The correlation between temperature classification and permissible ambient temperature ranges is shown in the table below:**

Temperature class	Permissible ambient temperature range
T6	60°C
T5	- 40°C ≤ ta ≤ 70°C
T4	80°C

**Table 4: For the Model 3730 – 231 . . . Positioner the correlation between temperature classification, permissible ambient temperature ranges and maximum short- circuit current is shown in the table below:**

Temperature class	Permissible ambient temperature range	Maximum short-circuit current
T6	45 °C	52 mA
T5	- 40° C ≤ ta ≤ 60 °C	
T4	75 °C	
T6	60 °C	25 mA
T5	- 40 °C ≤ ta ≤ 80 °C	
T4	80 °C	

**Intrinsically safe if installed as specified in manufacturer’s installation manual EB 8384-2 EN.  
 FM- approved for hazardous locations.**

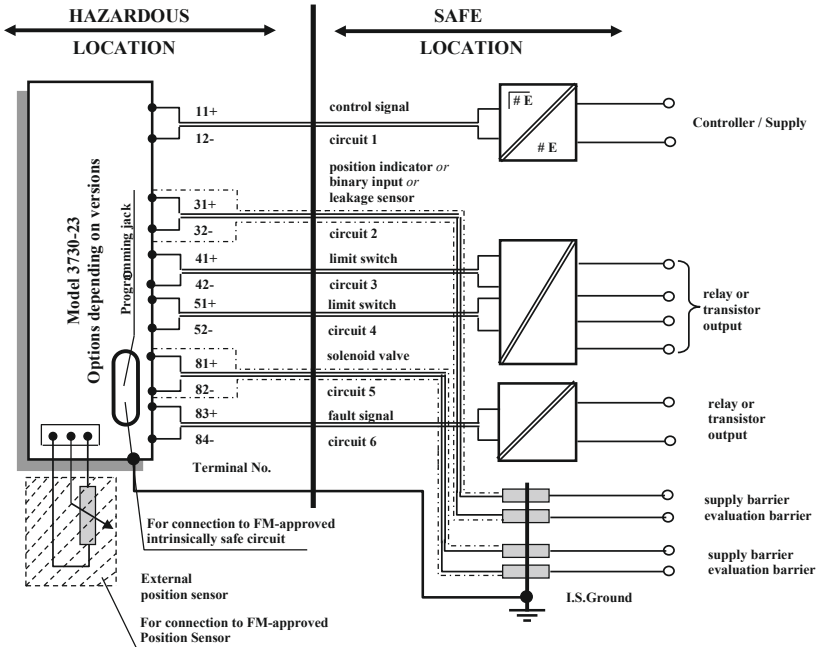
**Class I, Zone 0 AEx ia HC T6:**

**Class I, II, III, Div. 1, Groups A, B, C, D, E, F + G;**

**NEMA 4X**

**Notes:**

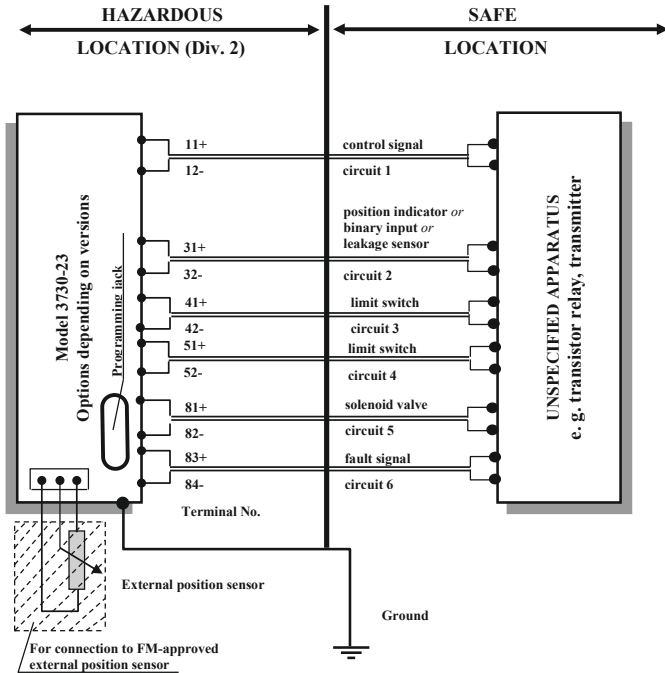
- 1.) The apparatus may be installed in intrinsically safe circuits only when used in conjunction with FM/CSA approved apparatus. For maximum values of  $U_i$  or  $V_{max}$ ;  $I_i$  or  $I_{max}$ ;  $P_i$  or  $P_{max}$ ;  $C_i$  and  $L_i$  of the various apparatus see Table 1 on page 1.
- 2.) For barrier selection see Table 2 on page 2.
- 3.) The installation shall be in accordance with the National Electrical Code ANSI/NFPA 70 and ANSI/ISA RP 12.06.01.
- 4.) Use only supply wires suitable for 5°C above surrounding temperature.
- 5.) Substitution of components may impair intrinsic safety.
- 6.) For the permissible maximum values for the intrinsically safe circuits 1,3,4 and 6 see Table 1
- 7.) For the permissible barrier parameters for the circuits 2 and 5 see Table 2
- 8.) Cable entry M 20 x 1.5 or metal conduit according to drawing No. 1050 – 0539 T or 1050 – 0540 T



Class I, Division 2, Groups A, B, C, D,  
Class II, Division 2 Groups F + G.

NEMA 4X

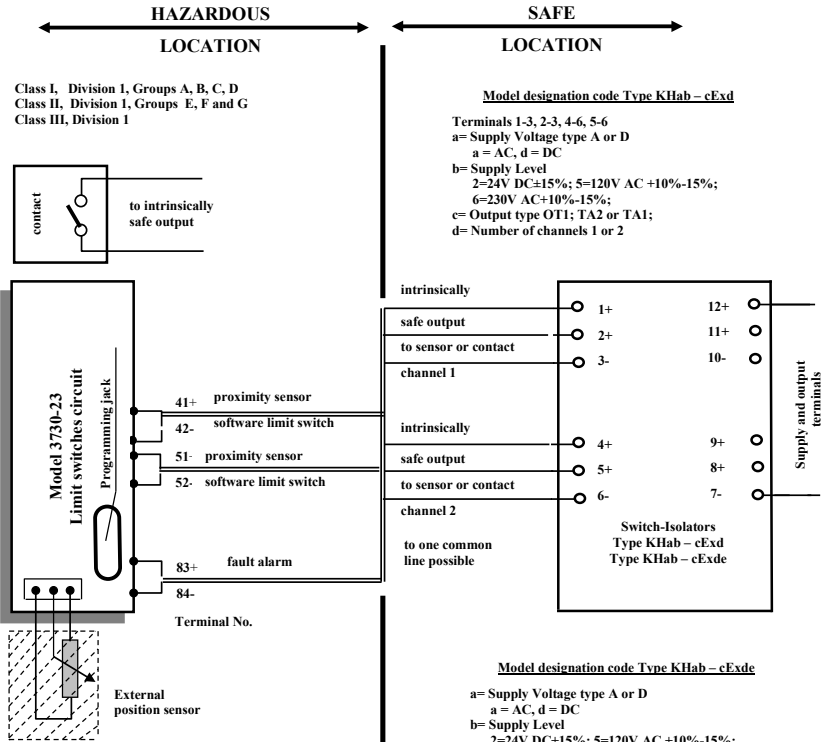
e/p positioner with position indicator or binary input or leakage detection, forced venting function (solenoid valve), fault signal and limit switches.



**Notes:**

- 1.) The installation shall be in accordance with the National Electrical Code ANSI/NFPA 70
- 2.) For the maximum values for the individual circuits see Table 1  
Cable entry only rigid metal conduit
- 3.) Substitution of components may impair intrinsic safety.

Installation drawing Control Relay KHab-cEx de Model SJ-b-N Proximity Sensors



maximum capacitance of each inductive sensor 60 nF  
maximum inductance of each inductive sensor 200 µH

The total series inductance and shunt capacitance of shield wiring shall be restricted to the following maximum values

Control Relay Terminal No.	Groups	L [mH]	C [µF]	V0C [V]	ISC [mA]
1-3; 2-3 4-6; 5-6	A + B	84.8	1.27	↑	↑
	C	299	3.82		
	D	744	10.2	↓	↓

Revision Control Number: 4 – August 2024

FM Addendum to EB 8384-2 EN



---

## EU Konformitätserklärung / EU Declaration of Conformity / Déclaration UE de conformité

Die alleinige Verantwortung für die Ausstellung dieser Konformitätserklärung trägt der Hersteller/  
This declaration of conformity is issued under the sole responsibility of the manufacturer/  
La présente déclaration de conformité est établie sous la seule responsabilité du fabricant.  
Für das folgende Produkt / For the following product / Nous certifions que le produit

### Elektropneumatischer Stellungsregler / Electropneumatic Positioner / Positionneur électropneumatique Typ/Type/Type 3730-2...

wird die Konformität mit den einschlägigen Harmonisierungsrechtsvorschriften der Union bestätigt/  
the conformity with the relevant Union harmonisation legislation is declared with/  
est conforme à la législation d'harmonisation de l'Union applicable selon les normes:

EMC 2014/30/EU

EN 61000-6-2:2005, EN 61000-6-3:2007  
+A1:2011, EN 61326-1:2013

RoHS 2011/65/EU

EN 50581:2012

Hersteller / Manufacturer / Fabricant:

SAMSON AKTIENGESELLSCHAFT  
Weismüllerstraße 3  
D-60314 Frankfurt am Main  
Deutschland/Germany/Allemagne

Frankfurt / Francfort, 2017-07-29

Im Namen des Herstellers/ On behalf of the Manufacturer/ Au nom du fabricant.

Hanno Zager  
Leiter Qualitätssicherung/Head of Quality Management/  
Responsable de l'assurance de la qualité

Dirk Hoffmann  
Zentralabteilungsleiter/Head of Department/Chef du département  
Entwicklungsorganisation/Development Organization

es\_3730-2\_de\_en\_fr\_rev07.pdf



## EU Konformitätserklärung / EU Declaration of Conformity / Déclaration UE de conformité

Die alleinige Verantwortung für die Ausstellung dieser Konformitätserklärung trägt der Hersteller/  
This declaration of conformity is issued under the sole responsibility of the manufacturer/  
La présente déclaration de conformité est établie sous la seule responsabilité du fabricant.  
Für das folgende Produkt / For the following product / Nous certifions que le produit

### Elektropneumatischer Stellungsregler / Electropneumatic Positioner / Positionneur électropneumatique Typ/Type/Type 3730-21..

- entsprechend der EU-Baumusterprüfbescheinigung PTB 00 ATEX 2158 ausgestellt von der/  
according to the EU Type Examination PTB 00 ATEX 2158 issued by/  
établi selon le certificat CE d'essais sur échantillons PTB 00 ATEX 2158 émis par:

Physikalisch Technische Bundesanstalt  
Bundesallee 100  
D-38116 Braunschweig  
Benannte Stelle/Notified Body/Organisme notifié 0102

- wird die Konformität mit den einschlägigen Harmonisierungsrechtsvorschriften der Union bestätigt/  
the conformity with the relevant Union harmonisation legislation is declared with/  
est conforme à la législation d'harmonisation de l'Union applicable selon les normes:

EMC 2014/30/EU	EN 61000-6-2:2005, EN 61000-6-3:2007 +A1:2011, EN 61326-1:2013
Explosion Protection 94/9/EC (bis/to 2016-04-19) Explosion Protection 2014/34/EU (ab/from 2016-04-20)	EN 60079-0:2012/A11:2013, EN 60079-11:2012, EN 60079-31:2014
RoHS 2011/65/EU	EN 50581:2012

Hersteller / Manufacturer / Fabricant:

SAMSON AKTIENGESELLSCHAFT  
Weismüllerstraße 3  
D-60314 Frankfurt am Main  
Deutschland/Germany/Allemagne

Frankfurt / Francfort, 2017-07-29

Im Namen des Herstellers/ On behalf of the Manufacturer/ Au nom du fabricant.

*H. Zager*

Hanno Zager  
Leiter Qualitätssicherung/Head of Quality Management/  
Responsable de l'assurance de la qualité

*D. Hoffmann*

Dirk Hoffmann  
Zentralabteilungsleiter/Head of Department/Chef de département  
Entwicklungsorganisation/Development Organization





## EU Konformitätserklärung / EU Declaration of Conformity / Déclaration UE de conformité

Die alleinige Verantwortung für die Ausstellung dieser Konformitätserklärung trägt der Hersteller/  
This declaration of conformity is issued under the sole responsibility of the manufacturer/  
La présente déclaration de conformité est établie sous la seule responsabilité du fabricant.  
Für das folgende Produkt / For the following product / Nous certifions que le produit

### Elektropneumatischer Stellungsregler / Electropneumatic Positioner / Positionneur électropneumatique Typ/Type/Type 3730-25..

- entsprechend der EU-Baumusterprüfbescheinigung PTB 00 ATEX 2158 ausgestellt von der/  
according to the EU Type Examination PTB 00 ATEX 2158 issued by/  
établi selon le certificat CE d'essais sur échantillons PTB 00 ATEX 2158 émis par:

Physikalisch Technische Bundesanstalt  
Bundesallee 100  
D-38116 Braunschweig  
Benannte Stelle/Notified Body/Organisme notifié 0102

- wird die Konformität mit den einschlägigen Harmonisierungsrechtsvorschriften der Union bestätigt /  
the conformity with the relevant Union harmonisation legislation is declared with/  
est conforme à la législation d'harmonisation de l'Union applicable selon les normes:

EMC 2014/30/EU	EN 61000-6-2:2005, EN 61000-6-3:2007 +A1:2011, EN 61326-1:2013
Explosion Protection 94/9/EC (bis/to 2016-04-19) Explosion Protection 2014/34/EU (ab/from 2016-04-20)	EN 60079-0:2012/A11:2013, EN 60079-11:2012, EN 60079-31:2014
RoHS 2011/65/EU	EN 50581:2012

Hersteller / Manufacturer / Fabricant:

SAMSON AKTIENGESELLSCHAFT  
Weismüllerstraße 3  
D-60314 Frankfurt am Main  
Deutschland/Germany/Allemagne

Frankfurt / Francfort, 2017-07-29

Im Namen des Herstellers/ On behalf of the Manufacturer/ Au nom du fabricant.

*H. Zager*

Hanno Zager  
Leiter Qualitätssicherung/Head of Quality Management/  
Responsable de l'assurance de la qualité

*D. Hoffmann*

Dirk Hoffmann  
Zentralabteilungsleiter/Head of Department/Chef de département  
Entwicklungsorganisation/Development Organization

ce\_3730-25\_de\_en\_fr\_07.pdf



## EU Konformitätserklärung / EU Declaration of Conformity / Déclaration UE de conformité

Die alleinige Verantwortung für die Ausstellung dieser Konformitätserklärung trägt der Hersteller/  
This declaration of conformity is issued under the sole responsibility of the manufacturer/  
La présente déclaration de conformité est établie sous la seule responsabilité du fabricant.  
Für das folgende Produkt / For the following product / Nous certifions que le produit

### Elektropneumatischer Stellungsregler / Electropneumatic Positioner / Positionneur électropneumatique Typ/Type/Type 3730-28..

- entsprechend der EU-Baumusterprüfbescheinigung PTB 03 ATEX 2016 X ausgestellt von der/  
according to the EU Type Examination PTB 03 ATEX 2016 X issued by/  
établi selon le certificat CE d'essais sur échantillons PTB 03 ATEX 2016 X émis par:

Physikalisch Technische Bundesanstalt  
Bundesallee 100  
D-38116 Braunschweig  
Benannte Stelle/Notified Body/Organisme notifié 0102

- wird die Konformität mit den einschlägigen Harmonisierungsrechtsvorschriften der Union bestätigt/  
the conformity with the relevant Union harmonisation legislation is declared with/  
est conforme à la législation d'harmonisation de l'Union applicable selon les normes:

EMC 2014/30/EU	EN 61000-6-2:2005, EN 61000-6-3:2007 +A1:2011, EN 61326-1:2013
Explosion Protection 94/9/EC (bis/to 2016-04-19) Explosion Protection 2014/34/EU (ab/from 2016-04-20)	EN 60079-0:2012/A11:2013, EN 60079-11:2012, EN 60079-31:2014
RoHS 2011/65/EU	EN 50581:2012

Hersteller / Manufacturer / Fabricant:

SAMSON AKTIENGESELLSCHAFT  
Weismüllerstraße 3  
D-60314 Frankfurt am Main  
Deutschland/Germany/Allemagne

Frankfurt / Francfort, 2017-07-29

Im Namen des Herstellers/ On behalf of the Manufacturer/ Au nom du fabricant.

*H. Zager*

Hanno Zager  
Leiter Qualitätssicherung/Head of Quality Management/  
Responsable de l'assurance de la qualité

*D. Hoffmann*

Dirk Hoffmann  
Zentralabteilungsleiter/Head of Department/Chef de département  
Entwicklungsorganisation/Development Organization



**EB 8384-2 EN**



SAMSON AKTIENGESELLSCHAFT  
Weismüllerstraße 3 · 60314 Frankfurt am Main, Germany  
Phone: +49 69 4009-0 · Fax: +49 69 4009-1507  
samson@samson.de · www.samson.de