

MOUNTING AND OPERATING INSTRUCTIONS



EB 8384-4 EN

Translation of original instructions



Old design



New design

Series 3730 Type 3730-4 Electropneumatic Positioner Communication: PROFIBUS-PA

Firmware version K 2.02/R 1.53



Edition April 2022

Note on these mounting and operating instructions

These mounting and operating instructions assist you in mounting and operating the device safely. The instructions are binding for handling SAMSON devices. The images shown in these instructions are for illustration purposes only. The actual product may vary.

- For the safe and proper use of these instructions, read them carefully and keep them for later reference.
- If you have any questions about these instructions, contact SAMSON's After-sales Service (aftersaleservice@samsongroup.com).



Documents relating to the device, such as the mounting and operating instructions, are available on our website at www.samsongroup.com > **Service & Support > Downloads > Documentation.**

Definition of signal words

DANGER

Hazardous situations which, if not avoided, will result in death or serious injury

WARNING

Hazardous situations which, if not avoided, could result in death or serious injury

NOTICE

Property damage message or malfunction

Note

Additional information

Tip

Recommended action

1	Safety instructions and measures	1-1
1.1	Notes on possible severe personal injury	1-4
1.2	Notes on possible personal injury	1-4
1.3	Notes on possible property damage	1-5
1.4	Special instructions concerning explosion protection	1-7
2	Markings on the device	2-1
2.1	Nameplate	2-1
2.2	Article code	2-2
2.3	Firmware versions	2-3
3	Design and principle of operation	3-1
3.1	Mounting versions	3-2
3.2	Additional equipment	3-2
3.3	Communication	3-3
3.4	Configuration using the TROVIS-VIEW software	3-3
3.5	Technical data	3-4
3.6	Dimensions in mm	3-9
3.6.1	Fixing levels according to VDI/VDE 3845 (September 2010)	3-13
4	Shipment and on-site transport	4-1
4.1	Accepting the delivered goods	4-1
4.2	Removing the packaging from the positioner	4-1
4.3	Transporting the positioner	4-1
4.4	Storing the positioner	4-1
5	Installation	5-1
5.1	Installation conditions	5-1
5.2	Preparation for installation	5-2
5.3	Adjusting the lever and pin position	5-2
5.4	Exchanging the lever	5-2
5.4.1	Travel tables	5-5
5.5	Positioner attachment	5-6
5.5.1	Direct attachment	5-6
5.5.2	Attachment according to IEC 60534-6	5-10
5.5.3	Attachment according to VDI/VDE 3847-1	5-12
5.5.4	Attachment according to VDI/VDE 3847-2	5-16
5.5.5	Attachment to Type 3510 Micro-flow Valve	5-24
5.5.6	Attachment to rotary actuators	5-24
5.5.7	Reversing amplifier for double-acting actuators	5-30
5.6	Attachment of external position sensor	5-30

Contents

5.6.1	Mounting the position sensor with direct attachment.....	5-31
5.6.2	Mounting the position sensor with attachment according to IEC 60534-6	5-32
5.6.3	Mounting the position sensor to Type 3510 Micro-flow Valve.....	5-34
5.6.4	Mounting on rotary actuators.....	5-35
5.7	Mounting the leakage sensor	5-36
5.8	Retrofitting inductive limit switch	5-37
5.9	Mounting positioners with stainless steel housings.....	5-38
5.10	Air purging function for single-acting actuators	5-38
5.11	Pneumatic connection.....	5-40
5.11.1	Signal pressure connection	5-41
5.11.2	Signal pressure reading.....	5-41
5.11.3	Supply pressure	5-41
5.11.4	Signal pressure (output).....	5-41
5.12	Electrical connection.....	5-42
5.12.1	Switching amplifier according to EN 60947-5-6	5-45
5.12.2	Establishing communication	5-45
5.13	Mounting accessories	5-47
6	Operation	6-1
7	Start-up and configuration.....	7-1
7.1	Determining the fail-safe position	7-2
7.2	Adjusting the volume restriction Q	7-3
7.3	Limiting the signal pressure	7-4
7.4	Checking the operating range of the positioner	7-5
7.5	Initializing the positioner	7-6
7.5.1	MAX – Initialization based on maximum range	7-8
7.5.2	NOM – Initialization based on nominal range	7-9
7.5.3	MAN – Initialization based on a manually selected OPEN position	7-11
7.5.4	SUB – Substitute calibration	7-12
7.6	Setting other parameters.....	7-17
7.7	Start-up via local interface (SSP)	7-18
7.8	Setting the bus address.....	7-18
7.9	Adjusting inductive limit switch.....	7-19
8	Operation	8-1
8.1	Adapting the display direction	8-1
8.2	Changing the operating mode	8-2
8.2.1	Closed-loop operation (automatic mode)	8-2
8.2.2	Manual mode.....	8-2
8.2.3	Fail-safe position (SAFE).....	8-3

8.3	Performing zero calibration	8-4
8.4	Resetting the positioner	8-5
9	Malfunctions	9-1
9.1	Troubleshooting	9-2
9.2	Emergency action	9-3
10	Servicing.....	10-1
10.1	Cleaning the cover window.....	10-2
10.2	Cleaning the filters	10-2
10.3	Maintenance of the supply air pressure reducing stations	10-2
10.4	Firmware updates	10-2
10.5	Periodic inspection and testing of the positioner.....	10-2
11	Decommissioning	11-1
12	Removal	12-1
13	Repairs	13-1
13.1	Servicing explosion-protected devices.....	13-1
13.2	Returning devices to SAMSON	13-1
14	Disposal.....	14-1
15	Certificates.....	15-1
16	Annex A (configuration instructions).....	16-1
16.1	Parameters and functions.....	16-1
16.1.1	Error codes.....	16-8
16.2	Valve characteristic selection.....	16-17
17	Annex B.....	17-1
17.1	Accessories	17-1
17.2	After-sales service	17-6

1 Safety instructions and measures

Intended use

The SAMSON Type 3730-4 Positioner is mounted on pneumatic control valves and used to assign the valve position to the control signal. The device is designed to operate under exactly defined conditions (e.g. operating pressure, temperature). Therefore, operators must ensure that the positioner is only used in applications where the operating conditions correspond to the technical data. In case operators intend to use the positioner in applications or conditions other than those specified, contact SAMSON.

SAMSON does not assume any liability for damage resulting from the failure to use the device for its intended purpose or for damage caused by external forces or any other external factors.

➔ Refer to the technical data for limits and fields of application as well as possible uses.

Reasonably foreseeable misuse

The Type 3730-4 Positioner is **not** suitable for the following applications:

- Use outside the limits defined during sizing and by the technical data

Furthermore, the following activities do not comply with the intended use:

- Use of non-original spare parts
- Performing maintenance activities not described in these instructions

Qualifications of operating personnel

The positioner must be mounted, started up or operated only by trained and experienced personnel familiar with the product. According to these mounting and operating instructions, trained personnel refers to individuals who are able to judge the work they are assigned to and recognize possible hazards due to their specialized training, their knowledge and experience as well as their knowledge of the applicable standards.

Explosion-protected versions of this device must be operated only by personnel who has undergone special training or instructions or who is authorized to work on explosion-protected devices in hazardous areas.

Safety instructions and measures

Personal protective equipment

No personal protective equipment is required for the direct handling of the positioner. Work on the control valve may be necessary when mounting or removing the device.

- ➔ Observe the requirements for personal protective equipment specified in the valve documentation.
- ➔ Check with the plant operator for details on further protective equipment.

Revisions and other modifications

Revisions, conversions or other modifications of the product are not authorized by SAMSON. They are performed at the user's own risk and may lead to safety hazards, for example. Furthermore, the product may no longer meet the requirements for its intended use.

Safety features

Upon failure of the air supply or electric signal, the positioner vents the actuator, causing the valve to move to the fail-safe position determined by the actuator.

Warning against residual hazards

The positioner has direct influence on the control valve. Any hazards that could be caused in the valve by the process medium, the signal pressure or by moving parts are to be prevented by taking appropriate precautions. Plant operators and operating personnel must observe all hazard statements, warning and caution notes in these mounting and operating instructions, especially for installation, start-up and service work.

If inadmissible motions or forces are produced in the pneumatic actuator as a result of the supply pressure, it must be restricted using a suitable supply pressure reducing station.

Responsibilities of the operator

Operators are responsible for proper use and compliance with the safety regulations. Operators are obliged to provide these mounting and operating instructions to the operating personnel and to instruct them in proper operation. Furthermore, operators must ensure that operating personnel or third parties are not exposed to any danger.

Responsibilities of operating personnel

Operating personnel must read and understand these mounting and operating instructions as well as the specified hazard statements, warning and caution notes. Furthermore, the operating personnel must be familiar with the applicable health, safety and accident prevention regulations and comply with them.

Referenced standards, directives and regulations

Devices with a CE marking fulfill the following requirements of the Directives:

- Type 3730-4: 2014/30/EU, 2011/65/EU
- Type 3730-41/-45/-48: 2014/30/EU, 2014/34/EU, 2011/65/EU

Devices with an EAC marking fulfill the following requirements of the Regulations:

- Type 3730-4: TR CU 020/2011

See the 'Certificates' section for the declarations of conformity and EAC certificates.

Referenced documentation

The following documents apply in addition to these mounting and operating instructions:

- Operating instructions for valve diagnostics: ► EB 8389
- Configuration manual: ► KH 8384-4
- Safety manual: ► SH 8384-4
- The mounting and operating instructions of the components on which the positioner is mounted (valve, actuator, valve accessories etc.).

1.1 Notes on possible severe personal injury

DANGER

Risk of fatal injury due to the ignition of an explosive atmosphere.

Incorrect installation, operation or maintenance of the positioner in potentially explosive atmospheres may lead to ignition of the atmosphere and ultimately to death.

- The following regulations apply to installation in hazardous areas: EN 60079-14 (VDE 0165, Part 1).
- Installation, operation or maintenance of the positioner must only be performed by personnel who has undergone special training or instructions or who is authorized to work on explosion-protected devices in hazardous areas.
- Read the special instructions concerning explosion protection (see section 1.4).

1.2 Notes on possible personal injury

WARNING

Crush hazard arising from moving parts on the valve.

Control valves contain moving parts (actuator and plug stem), which can injure hands or fingers if inserted into the valve.

- Do not touch any moving valve parts while the control valve is in operation.
- Before performing any mounting or installation work on the positioner, put the control valve out of operation by disconnecting and locking the supply air and control signal.
- Do not impede the movement of the actuator and plug stem by inserting objects into the yoke.

Incorrect electrical connection will render the explosion protection unsafe.

- Adhere to the terminal assignment.
- Do not undo the enameled screws in or on the housing.

Intrinsic safety rendered ineffective in intrinsically safe devices.

Every time the positioner is operated, even not within the plant (e.g. during maintenance, calibration and work on equipment), it must be ensured that the conditions for intrinsically safe circuits are observed.

- Only connect intrinsically safe devices intended for use in intrinsically safe circuits to certified intrinsically safe input-connected units.
- Do not place intrinsically safe devices back into operation that were connected to intrinsically safe input-connected units without certification.
- Do not exceed the maximum permissible electric values specified in the EC type examination certificates when interconnecting intrinsically safe electrical equipment (U_i or U_0 , I_i or I_0 , P_i or P_0 , C_i or C_0 and L_i or L_0).

1.3 Notes on possible property damage

! NOTICE

Risk of damage to the positioner due to incorrect mounting position.

- Do not mount the positioner with the back of the device facing upward.
- Do not seal or restrict the vent opening when the device is installed on site.

Incorrect installation of the lever in positioner versions without a sliding clutch will damage the travel sensor.

- Hold the lever in position while removing or mounting it to prevent it from moving to the end stops.

An incorrect electric signal will damage the positioner.

The positioner is powered over the bus line.

- Only use a voltage source and never a current source.
- Connect the electrical wiring to the positioner according to the prescribed terminal assignment.

Malfunction due to initialization not yet completed.

The initialization causes the positioner to be calibrated to adapt it to the mounting situation. After initialization is completed, the positioner is ready for use.

- Initialize the positioner on first start-up.
- Re-initialize positioner after changing the mounting position.

Risk of positioner damage due to incorrect grounding of the electric welding equipment.

- Do not ground electric welding equipment near to the positioner.

Incorrect cleaning will damage the window.

The window is made of Makrolon® and will be damaged when cleaned with abrasive cleaning agents or agents containing solvents.

- Do not rub the window dry.
- Do not use any cleaning agents containing chlorine or alcohol or abrasive cleaning agents.
- Use a non-abrasive, soft cloth for cleaning.

1.4 Special instructions concerning explosion protection

Explosive dust atmospheres of zone 21 or zone 22

- The following applies to type of protection Ex i in combustible dust atmospheres:
 - If intrinsic safety is impaired by the influence of dust, an enclosure complying with Clause 6.1.3 of EN 60079-11 with at least degree of protection IP 5X must be used. The requirements according to Clause 6.1.3 apply to the cable entries and conduit systems accordingly.
 - The degree of ingress protection is verified by a test according to IEC 60529 and EN 60079-0 (e.g. performed by VDE).
- For use in the presence of combustible dust in compliance with type of protection Ex tb IIIC (protection by enclosure), observe clause 5.6.3 of EN 60079-14.

Equipment for use in zone 2/zone 22:

- In equipment operated according to type of protection Ex nA (non-sparking equipment) according to EN 60079-15, circuits may be connected, interrupted or switched while energized only during installation, maintenance or repair.
- Observe the special conditions of use mentioned in the statement of conformity for the rated values and the installation of the series-connected fuse for interconnection of Ex nA circuits.
- Positioners with type of protection Ex nA or Ex tc can be used with a cover with or without window.
- The Types 3730-41, 3730-45 and 3730-48 Positioners are 100 % identical in design, except for the marking and the housing cover.
- For type of protection Ex nA, connect the VCC connection in the program interface adapter in series with a fuse according to IEC 60127, 250 V F or T with a fuse rating of max. $I_N \leq 40$ mA.
- Connect the signal current circuit in series with a fuse according to IEC 60127-2/VI, 250 V T with a fuse rating of $I_N \leq 63$ mA.
- Connect the transmitter current circuit in series with a fuse according to IEC 60127-2/VI, 250 V T with a fuse rating of $I_N \leq 40$ mA.
- Install the fuses outside the hazardous area.

Servicing explosion-protected devices

- Observe the following for servicing equipment in a section relevant for explosion protection:
 - It must not be put back into operation until a qualified inspector has assessed the equipment according to explosion protection requirements, has issued an inspection certificate or given the device a mark of conformity. Inspection by a qualified inspector is not required if the manufacturer performed a routine test on the device before putting it back into operation. Document the passing of the routine test by attaching a mark of conformity to the device.
 - Replace explosion-protected components only with original, routine-tested components by the manufacturer.
 - Devices that have already been used outside hazardous areas and are intended for future use inside hazardous areas must comply with the safety requirements placed on serviced devices. They must be subjected to testing according to the specifications in EN 60079-19.
 - EN 60079-19 applies to servicing explosion-protected devices.
 - Use the protective cable designed by SAMSON when interconnecting non-intrinsically safe set point calibrators with intrinsically safe equipment for repair, calibration etc. to ensure that components relevant to explosion protection are not damaged.

2 Markings on the device

2.1 Nameplate

Version without explosion protection

SAMSON 3730-4 9

PROFIBUS Positioner
 Supply 1

Media access according to EN 61158-2
 PROFIBUS PA

Binary input
 5 to 30 V DC

Binary input
 Floating contact

Limit switch, inductive
 EN 60947-5-6 (NAMUR)

Solenoid valve
 $U_n = 24 \text{ V DC}$

 See technical data for ambient temperature

Diagnostics 3 10

Date 4

Firmware 5

Var.-ID 6 Serial no. 7

Model 8

SAMSON AG D-60314 Frankfurt Made in Germany

Explosion-protected version

SAMSON 3730-4 9

PROFIBUS Positioner
 Supply 1

Media access according to EN 61158-2
 PROFIBUS PA* (FISCO) field device

11

Binary input
 5 to 30 V DC

Binary input
 Floating contact

Leakage detection

Limit switch, inductive
 EN 60947-5-6 (NAMUR)

Solenoid valve
 $U_n = 24 \text{ V DC}$

* See technical data and explosion-protection certificate for permissible ambient temperature and maximum values for connection to certified intrinsically safe circuits.

 10

Diagnostics 3

Firmware 5 Date 4

Var.-ID 6 Serial no. 7

Model 8

SAMSON AG D-60314 Frankfurt Made in Germany

- 1 Supply pressure
- 2 Features: Yes/ No
 - Binary input 5 to 30 V DC
 - Binary input Floating contact
 - Leakage detection
 - Limit switch, inductive
 - Solenoid valve Nominal voltage 24 V DC
- 3 Diagnostics level
- 4 Date of manufacture
- 5 Firmware version
- 6 Configuration ID
- 7 Serial number
- 8 Model number
- 9 Approvals (CE, EAC, UKCA etc.)
- 10 Data Matrix code (electronic nameplate)
- 11 Explosion protection marking

Markings on the device

2.2 Article code

Positioner		Type 3730-4															
		x	x	x	0	x	0	x	x	1	x	0	0	x	0	x	x
With LCD and autotune, PROFIBUS-PA																	
Explosion protection																	
Without		0															
ATEX	II 2G Ex ia IIC T6 Gb; II 2D Ex ia III T80°C Db	1															
CSA	Ex ia IIC T6, Class I, II, Div. 1, Groups A–G; Ex nA II T6, Ex nL IIC T6; Class I, Div. 2, Groups A–D; Class II, Div. 1, Groups E–G	3															
FM	Class I, Zone 0 AEx ia IIC; Class I, II, III, Div.1, Groups A–G; Class I, Div.2, Groups A–D; Class II, Div. 2, Groups F, G																
ATEX	II 2D Ex tb IIIC T80°C Db	5															
ATEX	II 3G Ex nA IIC T6 Gc, II 3D Ex tc IIIC T80°C Dc	8															
Additional equipment																	
Inductive limit switch	Without	0															
	SJ2-SN (NC contact)	1	0														
Solenoid valve	Without	0															
	With, 24 V DC	4															
External position sensor	Without					0											
	With	0	1	0				0									
Binary input	Without									0							
	Floating contact								0	1							
Diagnostics																	
EXPERTplus										4							
Housing material																	
Aluminum (standard)												0					
Stainless steel 1.4581						0						1					
Special applications																	
Without																0	
Device compatible with paint																1	
Exhaust air port with 1/4-18 NPT thread, back of positioner sealed		0	0	0	0										2		
With additional vent hole and VDI/VDE 3847 adapter; without travel pick-off parts																6	

Positioner		Type 3730-4 x x x 0 x 0 x x 1 x 0 0 x 0 x x		
With additional vent hole			7	
Special version				
Without			0	0
CCC Ex	Ex ia IIC T4 ~ T6 Gb	1	0	0
CCC Ex	Ex ic IIC T4 ~ T6 Gc; Ex nA IIC T4 ~ T6 Gc	8	0	1
IECEX	Ex ia IIC T6...T4 Gb; Ex ia IIC T80°C Db	1	0	1
IECEX	Ex tb IIIC T80°C Db	5	0	3
IECEX	Ex nA IIC T6...T4 Gc; Ex tc IIIC T80°C Dc	8	0	1
EAC Ex	1Ex ia IIC T6; Ex tb IIIC T80°C Db X, IP66	1	0	1
TR CMU 1055	II 2G Ex ia IIC T6...T4 Gb; II 2D Ex ia IIIC T80 °C Db	1	0	4
TR CMU 1055	II 2D Ex tb IIIC T80 °C Db	5	0	4
TR CMU 1055	II 3G Ex ic nA IIC T6 Gc; II 3D Ex tc IIIC T80 °C Dc IP66	8	0	4

2.3 Firmware versions

Firmware revisions (Control R)	
Control R 1.43	R 1.44 to 1.46
	Internal revisions
	R 1.52
Diagnostics	All EXPERTplus diagnostic functions are available without having to activate them in the positioner (► EB 8389 on EXPERTplus Valve Diagnostics).
Code 48 extended	The following subitems have been added to Code 48: h0: Activation/deactivation reference test h1: Reference test completed (YES/No) h3: Automatic reset of diagnosis after this time h4: Remaining time until diagnosis reset
	R 1.53
	Internal revisions

Markings on the device

Firmware revisions (Communication K)
K 1.01 Internal revisions
K 1.10 The FEATURE_SELECT parameter allows you to set whether an active diagnostic function is to be reported by a GOOD_FUNCTION_CHECK or a BAD_FUNCTION_CHECK (▶ KH 8384-4).
K 1.11 <ul style="list-style-type: none">• More trigger conditions in the data logger (▶ KH 8384-4).• More additional functions (FEATURE_SELECT) (▶ KH 8384-4).• The limits of the discrete valve position (POS_D_LIMIT_LOW, POS_D_LIMIT_UP) can now be defined as required (▶ KH 8384-4).
K 1.12 Resetting the identification parameters resets all the parameters saved in the controller. The parameters saved in the controller are, however, not reset when just the start-up parameters are reset (▶ KH 8384-4).
K 1.13 Internal revisions
K 1.15 Feature of ID number adaptation according to PROFIBUS PA Profile 3.02 added. It allows a Type 3785 Positioner (Profile 2.0 and Profile 3.0) to be directly replaced with a Type 3730-4 Positioner in the compatibility mode (▶ KH 8384-4).
K 1.16 The function to suppress extended diagnostic messages allows messages for the PROFIBUS diagnosis protocol to be suppressed. The messages are still included in the condensed state according to their classification. The parameter to suppress the diagnostic messages exists in the following integrations: DD: 2.2.007 TROVIS-VIEW: >3.60.005 (device module) DTM: 1.3.0.1
K 1.17 The versions K 1.12 to K 1.16 do not save a set point received in acyclic data exchange as the valid value for the fail-safe action 'Last valid set point is used'. In the affected modules for data exchange, the polling for a valid set point has been changed to GOOD_NON_SPECIFIC.
K 2.00 Partial stroke test (PST) and full stroke test (FST) added
K 2.01 Internal revisions
K 2.02 Correction of cyclic communication of negative valve positions

Design and principle of operation

sure by the pressure regulator to compensate for any fluctuations in the supply pressure.

The positioner communicates and is powered using IEC 61158-2 transmission technology conforming to PROFIBUS-PA specifications.

As a standard feature, the positioner comes with a binary input for DC voltage signals to signalize process information over the PROFIBUS-PA network.

The extended EXPERTplus diagnostics are integrated into the positioner. They provide information on the positioner and generate diagnostic and status messages, which allow faults to be pinpointed quickly.

3.1 Mounting versions

The positioner is suitable for the following types of attachment using the corresponding accessories:

- Direct attachment to SAMSON Type 3277 Actuator
- Attachment to actuators according to IEC 60534-6
- Attachment according to VDI/VDE 3847-1/-2
- Attachment to Type 3510 Micro-flow Valve
- Attachment to rotary actuators according to VDI/VDE 3845

3.2 Additional equipment

Solenoid valve

If the voltage supply for the solenoid valve (12) fails, the supply pressure for the i/p

converter is vented to the atmosphere. The positioner can no longer operate and the control valve moves to the fail-safe position determined by the actuator, regardless of the set point.

NOTICE

The manual set point is also reset to 0 % after the solenoid valve is activated. A different manual set point must be entered again (Code 1).

Inductive limit switch

In this version, the rotary shaft of the positioner carries an adjustable tag which actuates the built-in proximity switch.

External position sensor

In this version, only the sensor is mounted to the control valve. The positioner is located separately from the valve. The connection of x and y signals to the valve is established by cable and piping for air (only without inductive limit switch).

Binary input BI1

As a standard feature, the positioner comes with a binary input for DC voltage signals to signalize process information over the PROFIBUS-PA network.

Binary input BI2

This binary input BI2 is optional. It is an active input which is powered by the positioner to connect a floating contact. The switching state of the floating contact can be indicated over the PROFIBUS-PA network.

3.3 Communication

The positioner is controlled completely by digital signal transmission according to PROFIBUS-PA profile class B according to DIN EN 50170 and DIN 19245-4.

Data are transmitted over the bus using digital, bit-synchronous Manchester coding at a Baud rate of 31.25 kbit/s over twisted-pair wires according to IEC 61158-2.

Usually, the positioner settings are made on a computer. One or more positioners can be connected over a segment coupler to the PROFIBUS segment of the computer.

Configuration and operation of the positioner over PROFIBUS-PA are described in the Configuration Manual ▶ KH 8384-4.

3.4 Configuration using the TROVIS-VIEW software

The positioner can be configured with SAMSON's TROVIS-VIEW Software.

The positioner has for this purpose a **serial interface** to allow the RS-232 or USB port of a computer to be connected to it using an adapter cable.

The TROVIS-VIEW software enables the user to easily configure the positioner as well as view process parameters online.

i Note

TROVIS-VIEW provides a uniform user interface that allows users to configure and parameterize various SAMSON devices using device-specific database modules. The device module 3730-4 can be downloaded free of charge from our website at

▶ www.samsongroup.com > SERVICE & SUPPORT > Downloads > TROVIS-VIEW. Further information on TROVIS-VIEW (e.g. system requirements) is available on our website and in the Data Sheet ▶ T 6661.

3.5 Technical data

Table 3-1: Type 3730-4 Electropneumatic Positioner

Type 3730-4 Positioner with PROFIBUS-PA communication			
The technical data for the explosion-protected devices may be restricted by the limits specified in the test certificates.			
Valve travel	Adjustable	Direct attachment to Type 3277 Actuator	3.6 to 30 mm
		Attachment according to IEC 60534-6 (NAMUR)	3.6 to 300 mm
		Attachment according to VDI/VDE 3847	3.6 to 300 mm
		Attachment to rotary actuators (VDI/VDE 3845)	24 to 100° opening angle
Travel range	Adjustable	Adjustable within the initialized travel/angle of rotation of the valve; travel can be restricted to 1/5 at the maximum.	
Bus connection		Fieldbus interface according to IEC 61158-2, bus-powered Field device according to FISCO (Fieldbus Intrinsically Safe Concept)	
Communication			
Fieldbus		Data transmission conforming to PROFIBUS-PA specification acc. to IEC 61158 and IEC 61784 Certified DTM file acc. to FDT specification 1.2, suitable for integrating the positioner into frame applications that support the FDT/DTM concept. Other integrations, e.g. into SIMATIC PDM using EDD	
Local Software requirements		SAMSON SSP interface and serial interface adapter TROVIS-VIEW with device module 3730-4	
Permissible voltage supply		9 to 32 V DC · Powered by bus line Observe the limits in the test certificate for explosion-protected versions.	
Maximum operating current		15 mA	
Additional current in case of error		0 mA	
Supply	Supply air	1.4 to 7 bar (20 to 105 psi) Air quality acc. to ISO 8573-1: 2001 Max. particle size and quantity: Class 4 · Oil content: Class 3 · Humidity and water: Class 3 · Pressure dew point at least 10 K below the lowest ambient temperature to be expected	
Signal pressure (output)		0 bar up to the supply pressure · Can be limited to 1.4/2.4/3.7 bar ±0.2 bar by software	
Characteristic		Linear/Equal percentage/Reverse equal percentage · User-defined (over operating software and communication) · Butterfly valve linear/equal percentage · Rotary plug valve linear/equal percentage · Segmented ball valve linear/equal percentage Deviation from characteristic ≤ 1 %	
Hysteresis		≤0.3 %	

Type 3730-4 Positioner with PROFIBUS-PA communication The technical data for the explosion-protected devices may be restricted by the limits specified in the test certificates.		
Sensitivity	≤0.1 %	
Direction of action	Reversible	
Air consumption	Independent of supply air approx. < 110 l _n /h	
Air output capacity	Actuator (supply) At Δp = 6 bar: 8.5 m _n ³ /h · At Δp = 1.4 bar: 3.0 m _n ³ /h · K _{Vmax(20 °C)} = 0.09	
	Actuator (exhaust) At Δp = 6 bar: 14.0 m _n ³ /h · At Δp = 1.4 bar: 4.5 m _n ³ /h · K _{Vmax(20 °C)} = 0.15	
Permissible ambient temperature	-20 to +80 °C for all versions -45 to +80 °C with metal cable gland The temperature limits for the explosion-protected devices may be restricted by the limits specified in the test certificates.	
Influences	Temperature	≤0.15 %/10 K
	Supply air	None
	Effect of vibration	≤ 0.25 % up to 2 kHz and 4 g according to IEC 770
EMC	Complying with EN 61000-6-2, EN 61000-6-3, EN 61326-1 and NAMUR Recommendation NE 21	
Explosion protection	Refer to Table 3-3	
Electrical connections	One M20x1.5 cable gland for 6 to 12 mm clamping range · Second M20x1.5 threaded connection additionally exists · Screw terminals for 0.2 to 2.5 mm ² wire cross-sections	
Degree of protection	IP 66/NEMA 4X	
Use in safety-instrumented systems (SIL) Emergency venting at 0 V set point and using optional solenoid valve	Observing the requirements of IEC 61508, the systematic capability of the pilot valve for emergency venting as a component in safety-instrumented systems is given. Use is possible on observing the requirements of IEC 61511 and the required hardware fault tolerance in safety-instrumented systems up to SIL 2 (single device/HFT = 0) and SIL 3 (redundant configuration/HFT = 1).	
Conformity		
Binary input BI1		
Input	0 to 30 V DC with reverse polarity protection · Static destruction limit 40 V/5.8 mA · Current consumption 3.5 mA at 24 V, galvanic isolation	
Signal	Signal '1' at U _e > 5 V · Signal '0' at U _e < 3 V	
Materials		
Housing	Die-cast aluminum EN AC-ALSi12(Fe) (EN AC-44300) acc. to DIN EN 1706, chrome and powder coating · Special version: stainless steel 1.4408	
External parts	Stainless steel 1.4404/316L	



Design and principle of operation

Type 3730-4 Positioner with PROFIBUS-PA communication The technical data for the explosion-protected devices may be restricted by the limits specified in the test certificates.	
Cable gland	M20x1.5, black polyamide
Weight	Approx. 1.0 kg · Special version in stainless steel: 2.2 kg



Table 3-2: Optional additional functions

Options for Type 3730-4	
Binary input BI2 for floating contact	
Switching input	R < 100 Ω · Contact load 100 mA · Static destruction limit 20 V/5.8 mA · Galvanic isolation
Solenoid valve · Approval acc. to IEC 61508/SIL	
Input	24 V DC · Maximum 40 V · Reverse polarity protection · Static destruction limit 40 V Power draw: $I = \frac{U - 5.7 \text{ V}}{3840 \text{ } \Omega}$ (corresponding to 4.8 mA at 24 V/114 mW)
Signal	Signal '0' no pick-up <12 V · Signal '1' safe pick-up >19 V (emergency venting at 0 V)
Service life	> 5 x 10 ⁶ switching cycles
K _V coefficient	0.15
Inductive limit switch by Pepperl+Fuchs	
	For connection to switching amplifier acc. to EN 60947-5-6
SJ2-SN proximity switch	Measuring plate not detected: ≥3 mA · Measuring plate detected: ≤1 mA
External position sensor	
Valve travel	Same as positioner
Cable	10 m · Flexible and durable · With M12x1 connector · Flame-retardant according to VDE 0472 · Resistant to oils, lubricants and coolants as well as other aggressive media
Permissible ambient temperature	-40 to +90 °C with a fixed connection between positioner and position sensor · The limits in the test certificate additionally apply for explosion-protected versions.
Immunity to vibration	Up to 10 g in the range of 10 Hz to 2 kHz
Degree of protection	IP 67

Table 3-3: Summary of explosion protection approvals

Type	Certification		Type of protection/comments	
-41		Number	PTB 04 ATEX 2109	II 2G Ex ia IIC T6 Gb II 2D Ex ia III T80°C Db
		Date	2017-05-11	
	CCC Ex	Number	2020322307002425	Ex ia IIC T4 ~ T6 Gb
		Date	2020-09-18	
		Valid until	2025-09-17	
	CCoE	Number	A P HQ MH 104 1444	Ex ia IIC T6
Date		2018-04-21		
Valid until		2023-04-20		
	Number	RU C-DE.HA65.B.00510/20	1Ex ia IIC T6/T5/T4 Gb X Ex tb IIIC T80 °C Db X	
	Date	2020-03-18		
	Valid until	2025-03-18		
IECEX	Number	IECEX PTB 06.0054	Ex ia IIC T6...T4 Gb; Ex ia IIC T80°C Db	
	Date	2017-07-17		
TR CMU 1055	Number	ZETC/35/2021	II 2G Ex ia IIC T6...T4 Gb II 2D Ex ia IIIC T80 °C Db	
	Date	2021-07-26		
	Valid until	2024-07-25		
-43	CSA	Number	1675787	Ex ia IIC T6, Class I, II, Div. 1, Groups A–G Ex nA II T6, Ex nL IIC T6; Class I, Div. 2, Groups A–D; Class II, Div. 1, Groups E–G Type 4 Enclosure
		Date	2017-05-24	
	FM	Number	3023605	Class I, Zone 0 AEx ia IIC; Class I, II, III, Div.1, Groups A–G; Class I, Div.2, Groups A–D; Class II, Div.2, Groups F, G
		Date	2006-03-15	

Design and principle of operation

Type	Certification		Type of protection/comments	
-45	 ¹⁾	Number PTB 04 ATEX 2109	II 2D Ex tb IIIC T80°C Db	
		Date 2017-05-11		
	IECEX	Number IECEx PTB 06.0054 Date 2017-07-17	Ex tb IIIC T80°C Db	
3730	TR CMU 1055	Number ZETC/35/2021	II 2D Ex tb IIIC T80 °C Db	
		Date 2021-07-26		
		Valid until 2024-07-25		
	-48	 ²⁾	Number PTB 05 ATEX 2010 X	II 3G Ex nA IIC T6 Gc II 3D Ex tc IIIC T80°C Dc
			Date 2017-06-22	
		CCC Ex	Number 2020322307002425	Ex ic IIC T4 ~ T6 Gc Ex nA IIC T4 ~ T6 Gc
			Date 2020-09-18 Valid until 2025-09-17	
	IECEX	Number IECEx PTB 06.0054	Ex nA IIC T6...T4 Gc; Ex tc IIIC T80°C Dc	
Date 2017-07-17				
TR CMU 1055	Number ZETC/35/2021	II 3G Ex ic nA IIC T6 Gc II 3D Ex tc IIIC T80 °C Dc IP66		
	Date 2021-07-26			
	Valid until 2024-07-25			

1) EC type examination certificate

2) Statement of conformity

3.6 Dimensions in mm

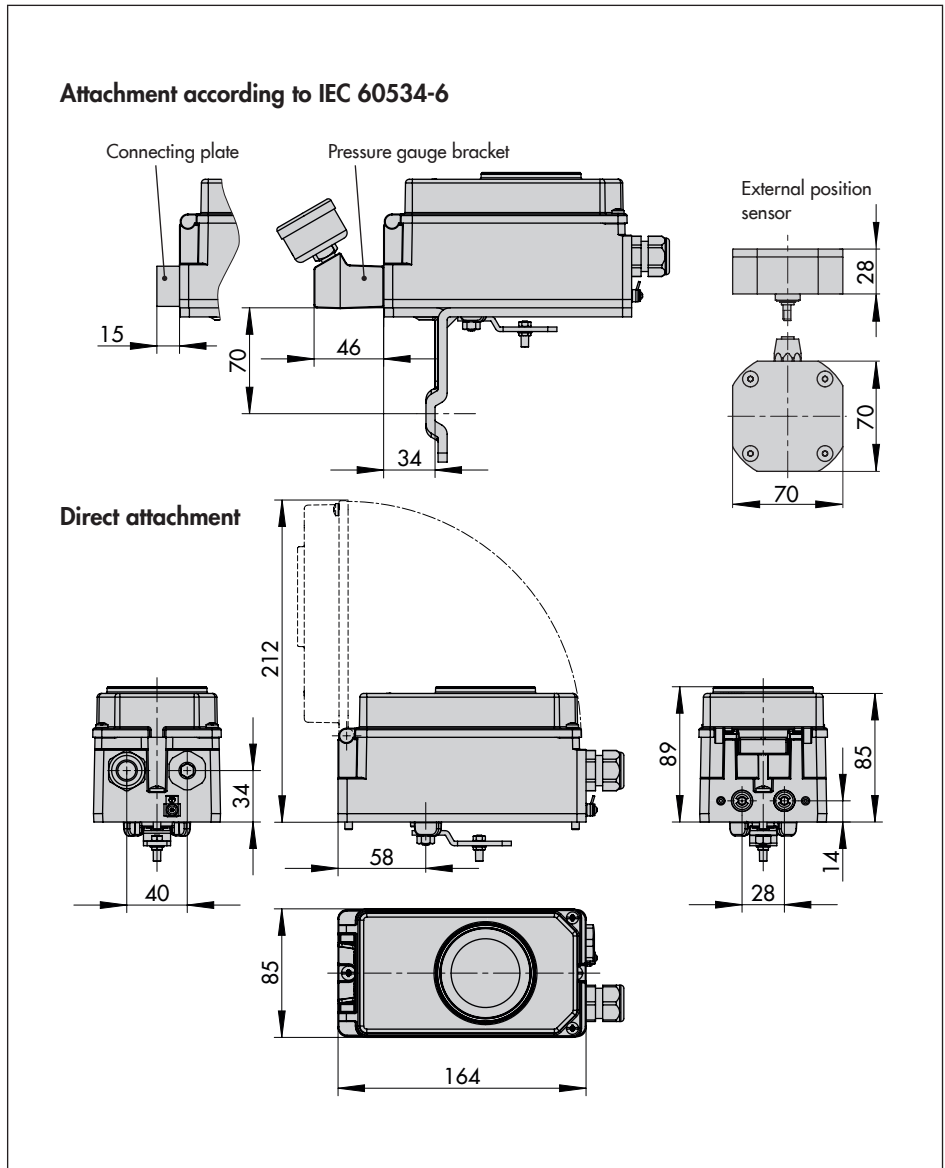

Attachment according to VDI/
VDE 3847-1 onto Type 3277 Actuator

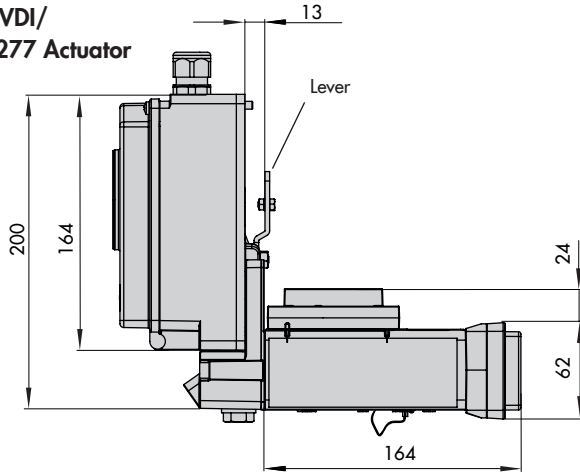

Attachment according to VDI/
VDE 3847-1 to a NAMUR rib

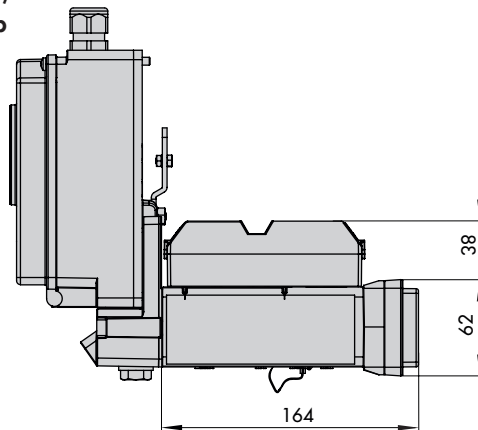

**Attachment according to VDI/VDE 3847-2
with single-acting actuator**

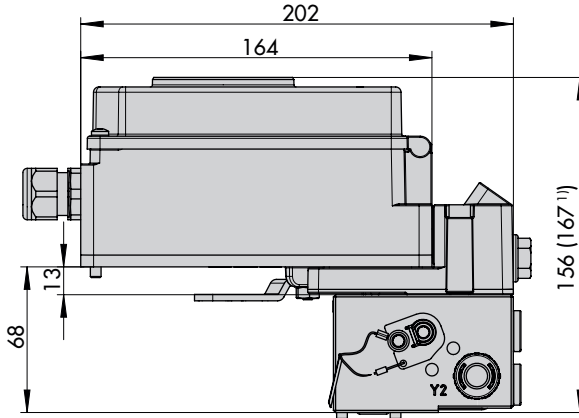

**Attachment according to VDI/VDE 3847-2
with double-acting actuator**

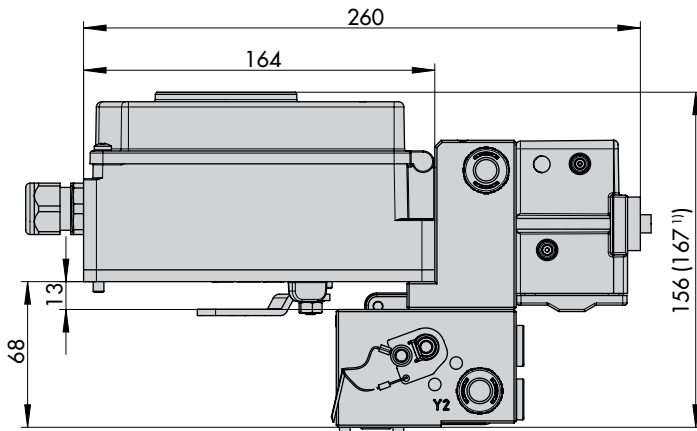

Attachment to rotary actuators according to VDI/VDE 3845

Heavy-duty version

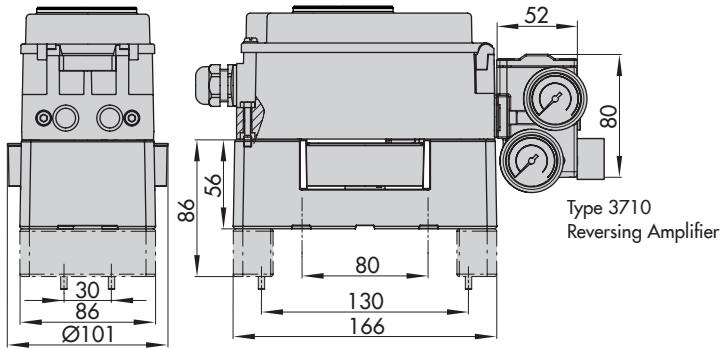

Light version

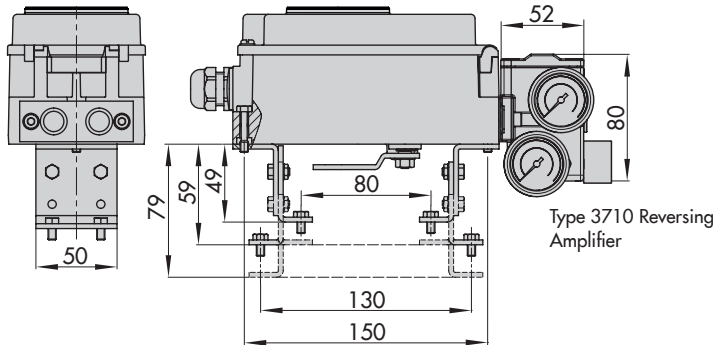

Lever

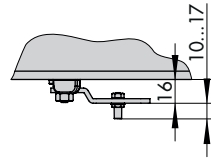
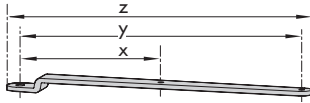

Lever	x	y	z
S	17 mm	25 mm	33 mm
M	25 mm	50 mm	66 mm
L	70 mm	100 mm	116 mm
XL	100 mm	200 mm	216 mm
XXL	200 mm	300 mm	316 mm

3.6.1 Fixing levels according to VDI/VDE 3845 (September 2010)

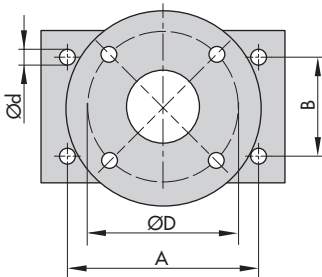
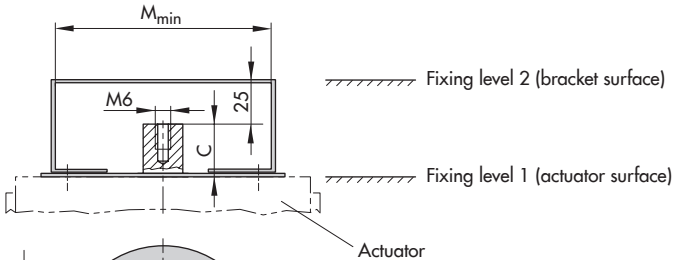

Dimensions in mm						
Size	A	B	C	Ød	M _{min}	D ¹⁾
AA0	50	25	15	5.5 for M5	66	50
AA1	80	30	20	5.5 for M5	96	50
AA2	80	30	30	5.5 for M5	96	50
AA3	130	30	30	5.5 for M5	146	50
AA4	130	30	50	5.5 for M5	146	50
AA5	200	50	80	6.5 for M6	220	50

¹⁾ Flange type F05 acc. to DIN EN ISO 5211

4 Shipment and on-site transport

The work described in this section is only to be performed by personnel appropriately qualified to carry out such tasks.

4.1 Accepting the delivered goods

After receiving the shipment, proceed as follows:

1. Check the scope of delivery. Check that the specifications on the nameplate of the positioner match the specifications in the delivery note. See the 'Markings on the device' section for nameplate details.
2. Check the shipment for transportation damage. Report any damage to SAMSON and the forwarding agent (refer to delivery note).

4.2 Removing the packaging from the positioner

Observe the following sequence:

- Do not remove the packaging and the protective caps on the pneumatic ports until immediately before installation.
- Dispose and recycle the packaging in accordance with the local regulations.

4.3 Transporting the positioner

- Pack the positioner properly to comply with terms of transportation.

Transport instructions

- Protect the positioner against external influences (e.g. impact).
- Protect the positioner against moisture and dirt.
- Observe transport temperature depending on the permissible ambient temperature (see the 'Design and principle of operation' section).

4.4 Storing the positioner

! NOTICE

Risk of device damage due to improper storage.

- *Observe the storage instructions.*
- *Avoid long storage times.*
- *Contact SAMSON in case of different storage conditions.*

i Note

We recommend regularly checking the control valve and the prevailing storage conditions during long storage periods.

Storage instructions

- Protect the positioner against external influences (e.g. impact, shocks, vibration).

Shipment and on-site transport

- Do not damage the corrosion protection (coating).
- Protect the positioner against moisture and dirt. In damp spaces, prevent condensation. If necessary, use a drying agent or heating.
- Make sure that the ambient air is free of acids or other corrosive media.
- Observe storage temperature depending on the permissible ambient temperature (see the 'Design and principle of operation' section).
- Store the positioner with the cover closed.
- Seal the pneumatic and electrical connections.
- Do not place any objects on the positioner.

5 Installation

The work described in this section is only to be performed by personnel appropriately qualified to carry out such tasks.

⚠ DANGER

Risk of fatal injury due to the ignition of an explosive atmosphere.

- Observe EN 60079-14 (VDE 0165, Part 1) for work on the positioner in potentially explosive atmospheres.
- Work in potentially explosive atmospheres must only be performed by personnel who has undergone special training or instructions or who is authorized to work on explosion-protected devices in hazardous areas.

⚠ WARNING

Crush hazard arising from moving parts on the valve.

- Do not touch any moving valve parts while the control valve is in operation.
- Before performing any mounting or installation work on the positioner, put the control valve out of operation by disconnecting and locking the supply air and control signal.
- Do not impede the movement of the actuator and plug stem by inserting objects into the yoke.

📌 NOTICE

Risk of malfunction due to incorrect mounting parts/accessories.

- Only use the mounting parts and accessories listed in these mounting and operating instructions to mount and install the positioner. Pay special attention to the type of attachment.

5.1 Installation conditions

Work position

The work position for the positioner is the front view onto the operating controls on the positioner seen from the position of operating personnel.

Operators must ensure that, after installation of the positioner, the operating personnel can perform all necessary work safely and easily access the device from the work position.

Mounting orientation

- Observe mounting position (see Fig. 5-2).
- Do not seal or restrict the vent opening (see Fig. 5-1) when the device is installed on site.

5.2 Preparation for installation

Before mounting, make sure the following conditions are met:

- The positioner is not damaged.
- The air supply is not yet connected to the positioner.
- The current is not yet connected to the positioner.

Proceed as follows:

- ➔ Lay out the necessary material and tools to have them ready during mounting.
- ➔ Adjust correct lever and pin position (see section 5.3).
- ➔ Seal the signal pressure output at the back of the positioner with the screw plug (4, order no. 0180-1436) and the associated O-ring (order no. 0520-0412) if the screw plug is not yet in place.
- ➔ Remove the protective caps from the pneumatic connections.

5.3 Adjusting the lever and pin position

i Note

The **M** lever is included in the scope of delivery.

S, **L** and **XL** levers are available as accessories (see section 5.13).

The **XXL** lever is available on request.

The positioner is adapted to the actuator and to the rated travel by the lever on the back of

the positioner and the pin inserted into the lever.

The travel tables on page 5-5 show the maximum adjustment range at the positioner. The travel that can be implemented at the valve is additionally restricted by the selected fail-safe position and the required compression of the actuator springs.

The positioner is equipped with the M lever (pin position 35) as standard (see Fig. 5-3). If a pin position other than position 35 with the standard M lever is required or an L or XL lever size is required, proceed as follows (see Fig. 5-4):

1. Unthread the nut (1.1) to unfasten the mounted lever.
 - ➔ Make sure that the lever does not rest on the end stops.
2. Fasten the follower pin (2) in the assigned lever hole (pin position as specified in the travel tables on page 5-5). Only use the longer follower pin included in the mounting kit.
3. Place the lever (1) on the shaft of the positioner and fasten it tight using the disk spring (1.2) and nut (1.1).
 - ➔ Make sure that the lever does not rest on the end stops.

5.4 Exchanging the lever

The procedure to exchange the lever depends on whether the standard version of the positioner has been ordered with a sliding clutch or the special version without a sliding clutch.

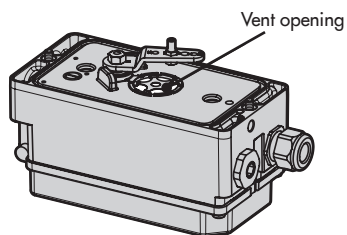

Fig. 5-1: Vent opening
(back of the positioner)

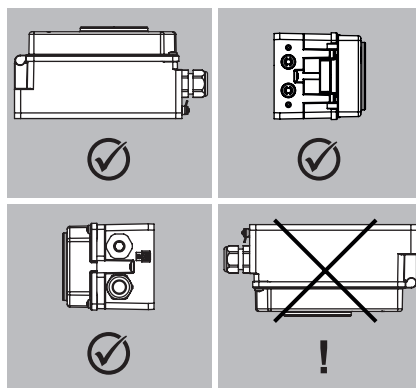
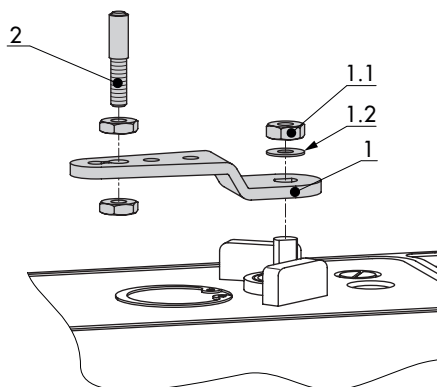

Fig. 5-2: Permissible mounting positions



- 1 Lever
- 1.1 Nut
- 1.2 Disk spring
- 2 Follower pin

Fig. 5-4: Mounting the lever and follower pin

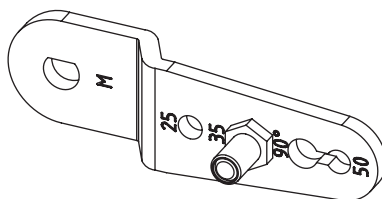

Fig. 5-3: M lever with pin position 35

Installation

Special version of the positioner without sliding clutch can be identified by their article code. The article code is printed on the nameplate as "Model". Special versions of the positioner without sliding clutch are:

- Type 3730-4xxxxxxxxxxxxx**002**
- Type 3730-4xxxxxxxxxxxxx**018**
- Type 3730-4xxxxxxxxxxxxx**028**
- Type 3730-4xxxxxxxxxxxxx**036**
- Type 3730-4xxxxxxxxxxxxx**039**
- Type 3730-4xxxxxxxxxxxxx**048**

Lever exchange in standard version with sliding clutch

If a pin position other than position 35 with the standard M lever is required or an L or XL lever size is required, proceed as follows (see Fig. 5-4):

1. Unthread the nut (1.1) to unfasten the mounted lever.
2. Fasten the follower pin (2) in the assigned lever hole (pin position as specified in the travel tables on page 5-5). Only use the longer follower pin included in the mounting kit.
3. Place the lever (1) on the shaft of the positioner and fasten it tight using the disk spring (1.2) and nut (1.1).
4. Move the newly mounted lever once all the way as far as it will go in both directions to adapt it to the internal measuring lever.

Lever exchange in standard version without sliding clutch

NOTICE

Incorrect installation of the lever in positioner versions without a sliding clutch will damage the travel sensor.

→ *Hold the lever in position while removing or mounting it to prevent it from moving to the end stops.*

If a pin position other than position 35 with the standard M lever is required or an L or XL lever size is required, proceed as follows (see Fig. 5-4):

1. Unthread the nut (1.1) to unfasten the mounted lever. While doing so, hold the lever in the middle to ensure that it does not rest at the end stops.
2. Fasten the follower pin (2) in the assigned lever hole (pin position as specified in the travel tables on page 5-5). Only use the longer follower pin included in the mounting kit.
3. Place the lever (1) on the shaft of the positioner and fasten it tight using the disk spring (1.2) and nut (1.1). While doing so, hold the lever in the middle to ensure that it does not rest at the end stops.

5.4.1 Travel tables

Table 5-1: Direct attachment to Type 3277-5 and Type 3277 Actuator

Actuator size [cm ²]	Rated travel [mm]	Adjustment range at positioner ¹⁾	Required lever	Assigned pin position
		Travel [mm]		
120	7.5	5.0 to 25.0	M	25
120/175/240/350	15	7.0 to 35.0	M	35
355/700/750	30	10.0 to 50.0	M	50

¹⁾ The min./max. adjustment range is based on the NOM (nominal range) initialization mode

Table 5-2: Attachment according to IEC 60534-6 (NAMUR)

SAMSON valves with Type 3271 Actuator		Adjustment range at positioner Other control valves ¹⁾		Required lever	Assigned pin position
Actuator size [cm ²]	Rated travel [mm]	Min. travel [mm]	Max. travel [mm]		
60 and 120 with Type 3510 Valve	7.5	3.6	18.0	S	17
120	7.5	5.0	25.0	M	25
120/175/240/350	15	7.0	35.0	M	35
355/700/750	7.5	7.0	35.0	M	35
355/700/750	15 and 30	10.0	50.0	M	50
1000/1400/2800	30	14.0	70.0	L	70
	60	20.0	100.0	L	100
1400/2800	120	40.0	200.0	XL	200
See manufacturer's specifications	200	See manufacturer's specifications			300

¹⁾ The min./max. adjustment range is based on the NOM (nominal range) initialization mode

Table 5-3: Attachment to rotary actuators

Opening angle	Required lever	Assigned pin position
24 to 100°	M	90°

5.5 Positioner attachment

5.5.1 Direct attachment

a) Type 3277-5 Actuator

- ➔ Required mounting parts and accessories: Table 5-5
- ➔ Observe the travel table on page 5-5.

Actuator with 120 cm² (see Fig. 5-5)

Depending on the type of positioner attachment, the signal pressure is routed either left or right of the yoke through a hole to the actuator diaphragm. Depending on the fail-safe action of the actuator "actuator stem extends" or "actuator stem retracts" (valve closes or opens upon supply air failure), the switchover plate (9) must first be attached to the actuator yoke. Align the switchover plate with the corresponding symbol for left or right attachment according to the marking (view looking onto the switchover plate).

1. Mount connecting plate (6) or pressure gauge bracket (7) with pressure gauges on the positioner. Make sure that the two seals (6.1) are seated properly.
2. Remove screw plug (4) on the back of the positioner and seal the signal pressure output (38) on the connecting plate (6) or on the pressure gauge bracket (7) with the stopper (5) included in the accessories.
3. Place follower clamp (3) on the actuator stem, align it and screw tight so that the

mounting screw is located in the groove of the actuator stem.

4. Mount cover plate (10) with narrow side of the cut-out (Fig. 5-5, on the left) pointing towards the signal pressure connection. Make sure that the gasket (14) points towards the actuator yoke.
5. **15 mm travel:** Keep the follower pin (2) on the M lever (1) on the back of the positioner in the pin position 35 (delivered state).
7.5 mm travel: Remove the follower pin (2) from the pin position 35, reposition it in the hole for pin position 25 and screw tight.
While doing so, hold the lever in the middle to ensure that it does not rest at the end stops.
6. Insert molded seal (15) into the groove of the positioner housing and insert the seal (10.1) on the back of the housing.
7. Seal the signal pressure output at the back with the screw plug (4, order no. 0180-1436) and the associated O-ring (order no. 0520-0412).
8. Place positioner on the cover plate (10) in such a manner that the follower pin (2) rests on the top of the follower clamp (3). Adjust the lever (1) correspondingly and open the positioner cover to hold the positioner shaft in position at the cap or rotary pushbutton. The lever (1) must rest on the follower clamp with spring force. Fasten the positioner on the cover plate (10) using the two fastening screws.
9. Mount cover (11) on the other side.

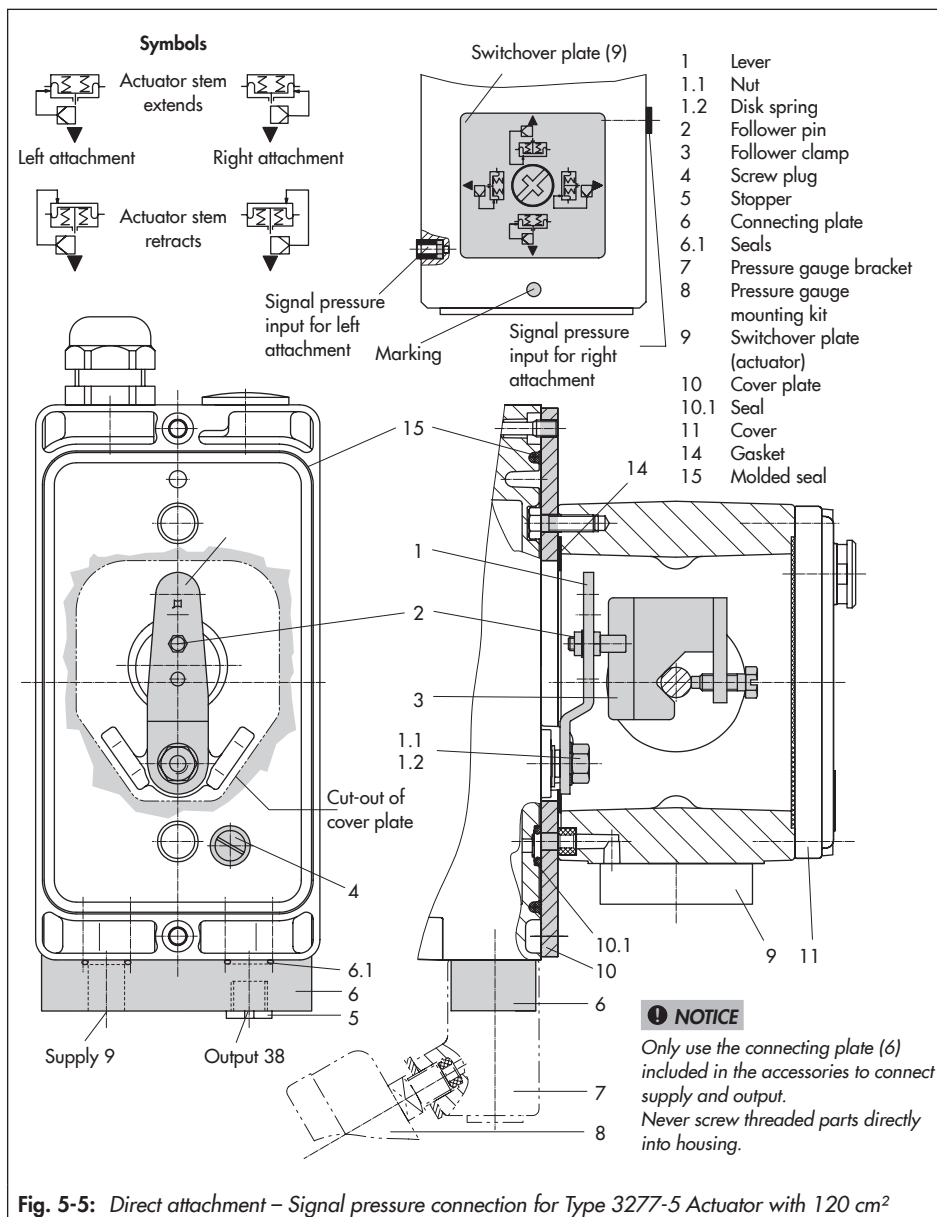

Fig. 5-5: Direct attachment – Signal pressure connection for Type 3277-5 Actuator with 120 cm²

- Make sure that the vent plug is located at the bottom when the control valve is installed to allow any condensed water that collects to drain off.

b) Type 3277 Actuator

- Required mounting parts and accessories: Table 5-6
- Observe the travel table on page 5-5.

Actuators with 175 to 750 cm² effective areas (see Fig. 5-6)

Mount the positioner on the yoke. The signal pressure is routed to the actuator over the connection block (12), for actuators with fail-safe action "actuator stem extends" internally through a hole in the valve yoke and for "actuator stem retracts" through an external pipe.

1. Place follower clamp (3) on the actuator stem, align it and screw tight so that the mounting screw is located in the groove of the actuator stem.
2. Mount cover plate (10) with narrow side of the cut-out (Fig. 5-6, on the left) pointing towards the signal pressure connection. Make sure that the gasket (14) points towards the actuator yoke.
3. For actuators with 355, 700 or 750 cm², remove the follower pin (2) on the M lever (1) on the back of the positioner from pin position 35, reposition it in the hole for pin position 50 and screw tight. While doing so, hold the lever in the middle to ensure that it does not rest at the end stops.

For actuators 175, 240 and 350 cm² with 15 mm travel, keep the follower pin (2) in pin position 35.

4. Insert molded seal (15) into the groove of the positioner housing.
5. Place positioner on the cover plate in such a manner that the follower pin (2) rests on the top of the follower clamp (3). Adjust the lever (1) correspondingly and open the positioner cover to hold the positioner shaft in position at the cap or rotary pushbutton. The lever (1) must rest on the follower clamp with spring force. Fasten the positioner on the cover plate (10) using the two fastening screws.
6. Make sure that the tip of the gasket (16) projecting from the side of the connection block is positioned to match the actuator symbol for the actuator's fail-safe action "actuator stem extends" or "actuator stem retracts". If this is not the case, unscrew the three fastening screws and lift off the cover. Turn the gasket (16) by 180° and re-insert it.
The old connection block version (Fig. 5-6, bottom) requires the switch plate (13) to be turned to align the actuator symbol with the arrow marking.
7. Place the connection block (12) with the associated seals against the positioner and the actuator yoke and fasten using the screw (12.1). For actuators with fail-safe action "actuator stem retracts", additionally remove the stopper (12.2) and mount the external signal pressure pipe.
8. Mount cover (11) on the other side.

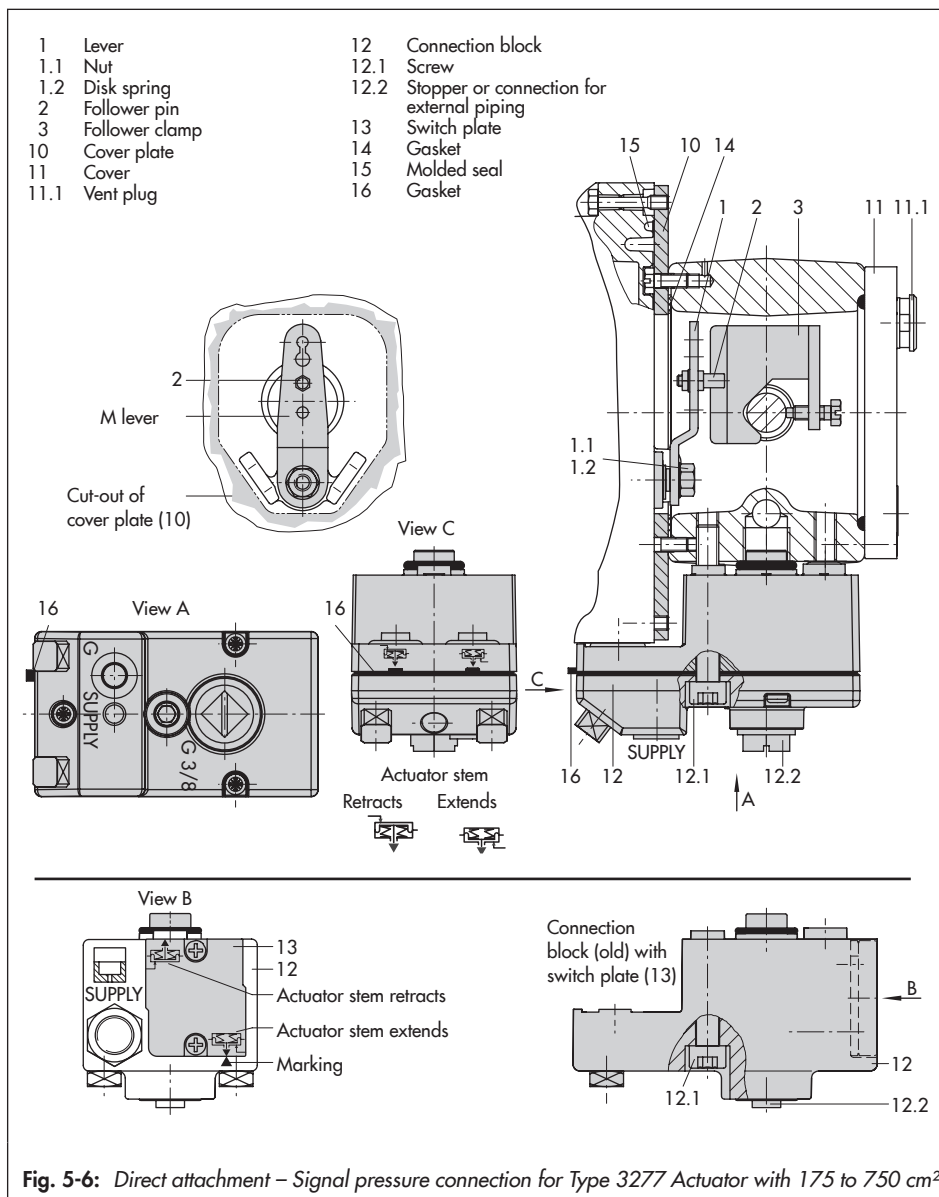

- Make sure that the vent plug is located at the bottom when the control valve is installed to allow any condensed water that collects to drain off.

5.5.2 Attachment according to IEC 60534-6

- See Fig. 5-7
 - Required mounting parts and accessories: Table 5-7
 - Observe the travel table on page 5-5.
- The positioner is attached to the control valve using a NAMUR bracket (10).

1. Screw the two bolts (14) to the bracket (9.1) of the stem connector (9), place the follower plate (3) on top and use the screws (14.1) for fastening.

Actuator sizes 2800 cm² and 1400 cm² with 120 mm travel:

- For a travel of 60 mm or smaller, screw the longer follower plate (3.1) directly to the stem connector (9).
 - For a travel exceeding 60 mm, mount the bracket (16) first and then the follower plate (3) to the bracket together with the bolts (14) and screws (14.1).
2. Mount NAMUR bracket (10) to the control valve as follows:
 - For **attachment to the NAMUR rib**, use an M8 screw (11) and toothed lock washer directly in the yoke hole.

- For attachment to **valves with rod-type yokes**, use two U-bolts (15) around the yoke. Align the NAMUR bracket (10) according to the embossed scale so that the follower plate (3) is shifted by half the angle range to the NAMUR bracket (the slot of the follower plate is centrally aligned with the NAMUR bracket at mid valve travel).

3. Mount connecting plate (6) or pressure gauge bracket (7) with pressure gauges (8) on the positioner. Make sure that the two seals (6.1) are seated properly.
4. Select required lever size (1) M, L or XL and pin position according to the actuator size and valve travel listed in the travel table on page 5-5.

If a pin position other than position **35** with the standard **M** lever is required or an **L** or **XL** lever size is required. Proceed as described in section 5.4.

5. Place positioner on the NAMUR bracket in such a manner that the follower pin (2) rests in the slot of the follower plate (3, 3.1). Adjust the lever (1) correspondingly.
Screw the positioner to the NAMUR bracket using its two fastening screws.

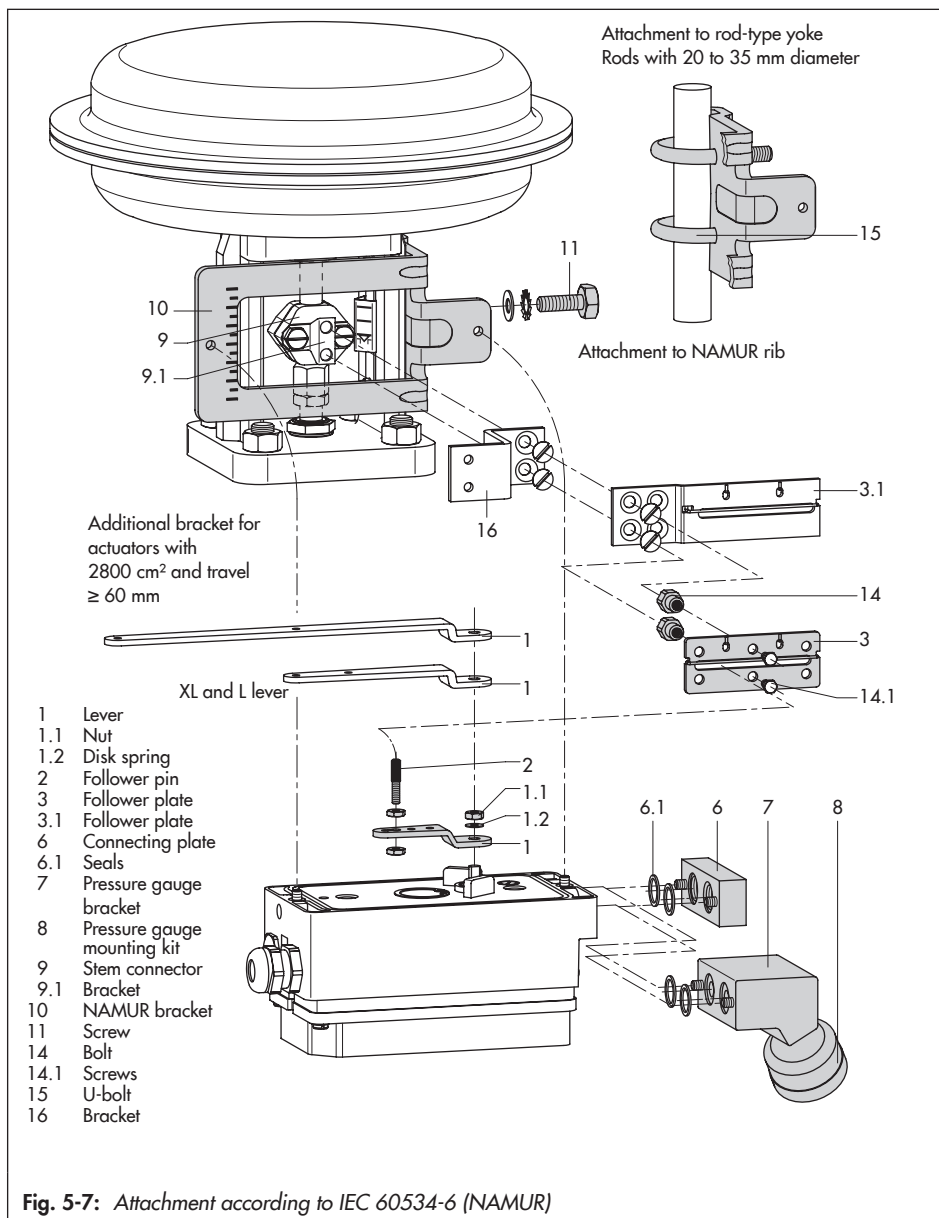

5.5.3 Attachment according to VDI/VDE 3847-1

The 3730-4-xxx0xxxx0x0060xx and 3730-4-xxx0xxxx0x007000 Positioners with air purging of the actuator's spring chamber can be attached according to VDI/VDE 3847-1.

The 3730-4-xxx0xxxx0x0000xx Positioner without air purging of the actuator's spring chamber can be attached according to VDI/VDE 3847.

This type of attachment allows the positioner to be replaced quickly while the process is running by blocking the air in the actuator. The signal pressure can be blocked in the actuator by unscrewing the red retaining screw (20) and turning the air blocker (19) on the bottom of the adapter block.

Attachment to Type 3277 Actuator (see Fig. 5-8)

→ Required mounting parts and accessories: see Table 5-8

Mount the positioner on the yoke as shown in Fig. 5-8. The signal pressure is routed to the actuator over the connecting plate (12), for actuators with fail-safe action "actuator stem extends" internally through a bore in the valve yoke and for "actuator stem retracts" through external piping.

Only the Y1 port is required for positioner attachment. The Y2 port can be used for air purging of the spring chamber.

1. Place follower clamp (3) on the actuator stem, align it and screw tight so that the

mounting screw is located in the groove of the actuator stem.

2. Place the adapter bracket (6) on the positioner and mount using the screws (6.1). Make sure that the seals are correctly seated. For positioners **with air purging**, remove the stopper (5) before mounting the positioner. For positioners **without air purging**, replace the screw plug (4) with a vent plug.
3. For actuators with 355, 700 or 750 cm², remove the follower pin (2) on the M lever (1) on the back of the positioner from pin position 35, reposition it in the hole for pin position 50 and screw tight. While doing so, hold the lever in the middle to ensure that it does not rest at the end stops.

For actuators 175, 240 and 350 cm² with 15 mm travel, keep the follower pin (2) in pin position 35.

4. Insert the molded seal (6.2) in the groove of the adapter bracket (6).
5. Insert the molded seal (17.1) into the turnboard (17) and mount the turnboard to the adapter block (13) using the screws (17.2).
6. Mount the dummy plate (18) to the turnboard (17) using the screws (18.1). Make sure that the seals are correctly seated.

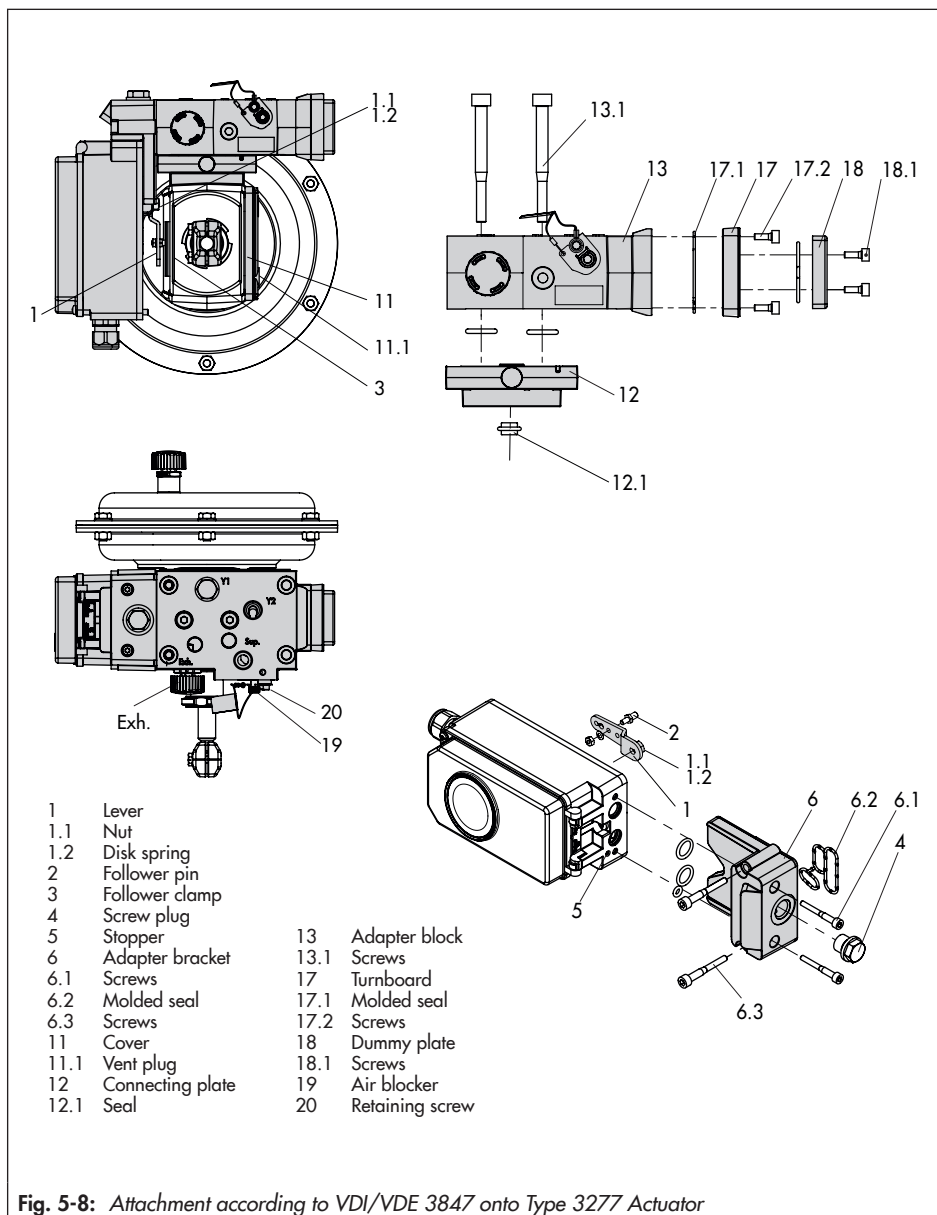
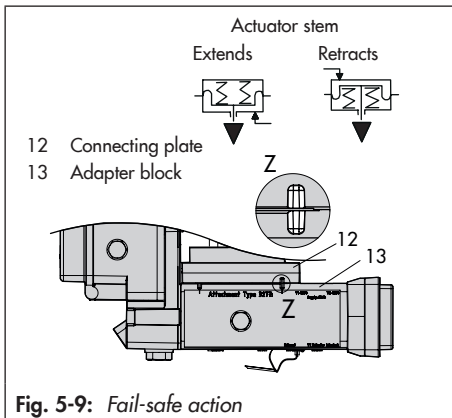

Fig. 5-8: Attachment according to VDI/VDE 3847 onto Type 3277 Actuator

i Note

A solenoid valve can also be mounted in place of the dummy plate (18). The orientation of the turnboard (17) determines the mounting position of the solenoid valve. Alternatively, a restrictor plate can be mounted (► AB 11).

7. Insert the screws (13.1) through the middle holes of the adapter block (13).
8. Place the connecting plate (12) together with the seal (12.1) onto the screws (13.1) corresponding to the fail-safe action "actuator stem extends" or "actuator stem retracts". The fail-safe action that applies is determined by aligning the groove of the adapter block (13) with the groove of the connecting plate (12) (Fig. 5-9).



9. Mount the adapter block (13) together with the connecting plate (12) to the actuator using the screws (13.1).

10. Insert the vent plug (11.1) into the **Exh.** connection.
11. For fail-safe action "actuator stem extends", seal the Y1 port with a blanking plug.

For fail-safe action "actuator stem retracts", connect the Y1 port to the signal pressure connection of the actuator.

Place positioner on the adapter block (13) in such a manner that the follower pin (2) rests on the top of the follower clamp (3). Adjust the lever (1) correspondingly and open the positioner cover to hold the positioner shaft in position at the cap or rotary pushbutton.

The lever (1) must rest on the follower clamp with spring force.

Fasten the positioner to the adapter block (13) using the two fastening screws (6.3). Make sure the molded seal (6.2) is properly seated.

12. Mount cover (11) on the other side to the yoke.

→ Make sure that the vent plug is located at the bottom when the control valve is installed to allow any condensed water that collects to drain off.

Attachment to NAMUR rib (see Fig. 5-10)

- Required mounting parts and accessories: see Table 5-8
- Observe the travel table on page 5-5.

1. **Series 240 Valves, actuator size up to 1400-60 cm²:** Screw the two bolts (14) to the bracket of the stem connector or directly to the stem connector (depending on the version), place the follower plate (3) on top and use the screws (14.1) to fasten it.

Type 3251 Valve, 350 to 2800 cm²:

Screw the longer follower plate (3.1) to the bracket of the stem connector or directly to the stem connector (depending on the version).

Type 3254 Valve, 1400-120 to 2800 cm²:

Screw the two bolts (14) to the bracket (16). Fasten the bracket (16) onto the stem connector, place the follower plate (3) on top and use the screws (14.1) to fasten it.

Mount the positioner on the NAMUR rib as shown in Fig. 5-10.

2. For **attachment to the NAMUR rib**, fasten the NAMUR connection block (10) directly into the existing yoke bore using the screw and toothed lock washer (11). Align the marking on the NAMUR valve connection (on the side marked '1') to 50 % travel.

For attachment to **valves with rod-type yokes** using the formed plate (15), which is placed around the yoke: screw the four studs into the NAMUR connection block (10). Place the NAMUR connection block on the rod and position the formed plate (15) on the opposite side. Use the nuts and toothed lock washers to fasten the formed plate onto the studs. Align the marking on the NAMUR valve connection (on the side marked '1') to 50 % travel.

3. Place the adapter bracket (6) on the positioner and mount using the screws (6.1). Make sure that the seals are correctly seated. For positioners **with air purging**, remove the stopper (5) before mounting the positioner. For positioners **without air purging**, replace the screw plug (4) with a vent plug.
4. Select required lever size (1) M, L or XL and pin position according to the actuator size and valve travel listed in the travel table on page 5-5.

If a pin position other than position 35 with the standard M lever is required or an L or XL lever size is required. Proceed as described in section 5.4.

5. Insert the molded seal (6.2) in the groove of the adapter bracket.
6. Insert the molded seal (17.1) into the turnboard (17) and mount the turnboard to the adapter block (13) using the screws (17.2).

7. Mount the dummy plate (18) to the turnboard using the screws (18.1). Make sure that the seals are correctly seated.

i Note

A solenoid valve can also be mounted in place of the dummy plate (18). The orientation of the turnboard (17) determines the mounting position of the solenoid valve. Alternatively, a restrictor plate can be mounted (▶ AB 11).

8. Fasten the adapter block (13) to the NAMUR connection block using the screws (13.1).
9. Insert the vent plug into the Exh. connection.
10. Place the positioner on the adapter block (13) in such a manner that the follower pin (2) rests on the top of the follower plate (3, 3.1). Adjust the lever (1) correspondingly.
Fasten the positioner to the adapter block (13) using the two fastening screws (6.3). Make sure the molded seal (6.2) is properly seated.
11. For **single-acting actuators without air purging**, connect the Y1 port of the adapter block to the signal pressure connection of the actuator. Seal the Y2 port with a blanking plug.

For **double-acting actuators and actuators with air purging**, connect the Y2 port of the adapter block to the signal pressure connection of the second actuator chamber or spring chamber of the actuator.

5.5.4 Attachment according to VDI/VDE 3847-2

Attachment according to VDI/VDE 3847-2 for PFEIFFER SRP (single-acting) and DAP (double-acting) rotary actuators in sizes 60 to 1200 with NAMUR interface and air purging of the actuator's spring chamber allows the direct attachment of the positioner without additional piping.

Additionally, the positioner can be replaced quickly while the process is running by blocking the air in single-acting actuators.

Procedure to block the actuator in place (see Fig. 5-11):

1. Unscrew the red retaining screw (1).
2. Turn the air blocker (2) on the bottom of the adapter block according to the inscription.

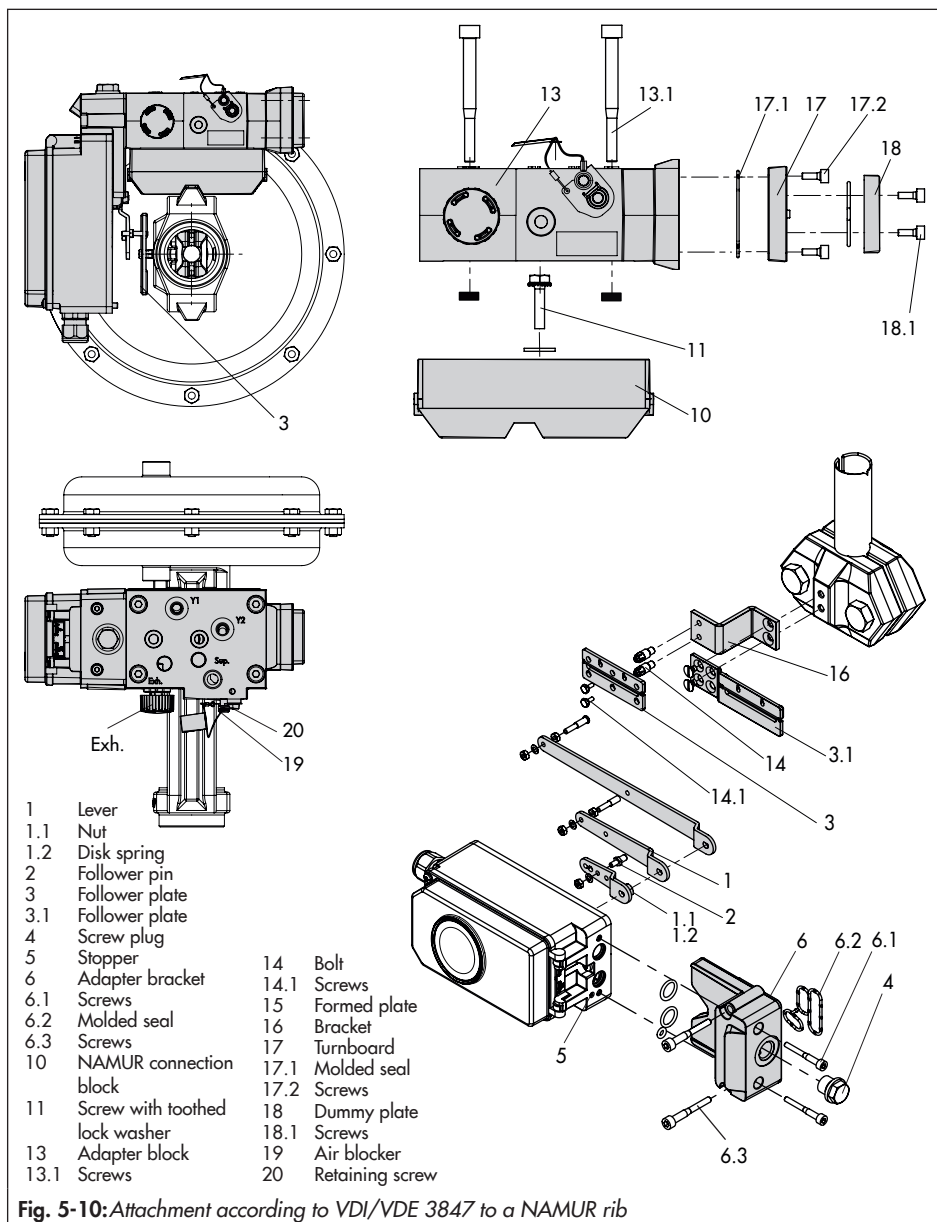

a) Version for single-acting actuator

Mounting onto a PFEIFFER Type 31a (edition 2020+) SRP Rotary Actuator

→ See Fig. 5-13

1. Fasten the adapter block (1) to the actuator's NAMUR interface using the four fastening screws (2).
 - Make sure that the seals are correctly seated.
2. Mount the follower wheel (3) onto the actuator shaft. Use the matching shaft adapter (see Table 5-9).
3. Place the adapter bracket (4) onto the adapter block (1) and fasten it using the fastening screws (5).
 - Make sure that the seals are correctly seated.
4. Insert and fasten the follower pin in the 90° position on the positioner's lever (see Fig. 5-12).
 - Only use the longer follower pin included in the mounting kit.
5. Align the positioner on the adapter bracket (1) in such a way that the follower pin engages into the actuator's follower wheel (3).
6. Fasten the positioner onto the adapter bracket (4) using the fastening screws (6).
 - Make sure that the seals are correctly seated.

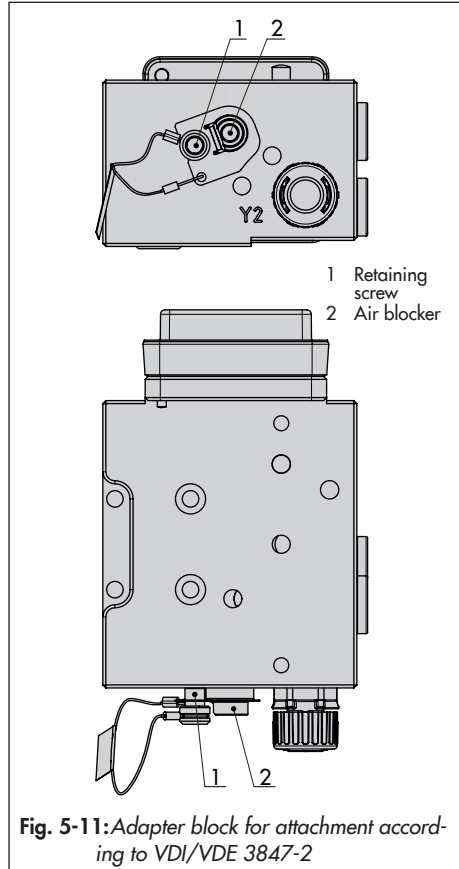

Fig. 5-11: Adapter block for attachment according to VDI/VDE 3847-2

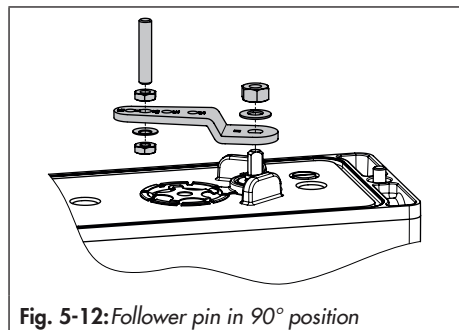

Fig. 5-12: Follower pin in 90° position

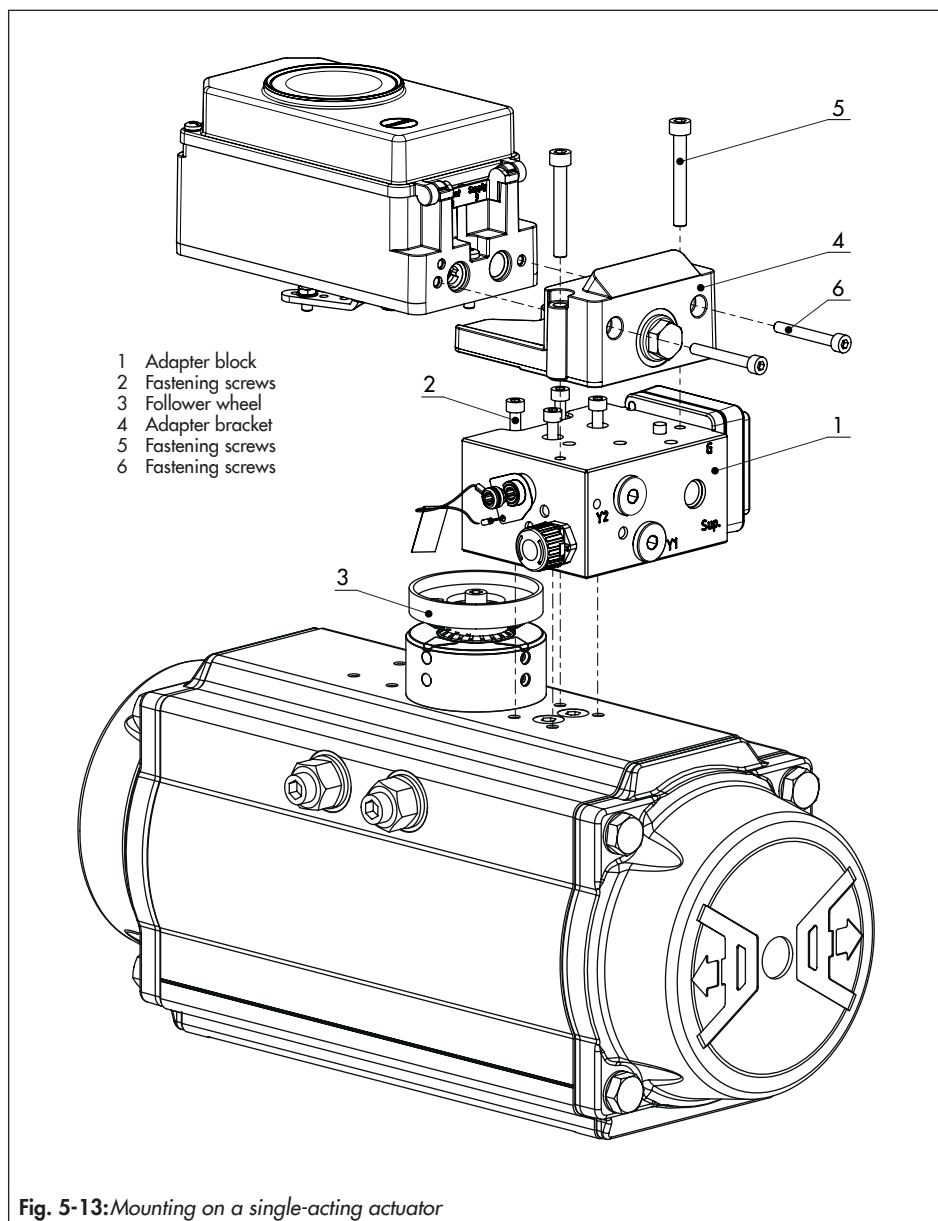

Fig. 5-13: Mounting on a single-acting actuator

b) Version for double-acting actuator

A reversing amplifier must be additionally mounted for applications with double-acting (DAP) actuators or applications with single-acting (SAP) actuators that include partial stroke testing.

In this case, a special adapter bracket (4) is required for mounting.

→ See Fig. 5-15

1. Fasten the adapter block (1) to the actuator's NAMUR interface using the four fastening screws (2).
→ Make sure that the seals are correctly seated.
2. Mount the follower wheel (3) onto the actuator shaft. Use the matching adapter (see Table 5-9).
3. Place the adapter bracket (4) onto the adapter block (1) and fasten it using the fastening screws (5).
→ Make sure that the seals are correctly seated.
4. Insert and fasten the follower pin in the 90° position on the positioner's lever (see Fig. 5-12).
5. Align the positioner on the adapter bracket (1) in such a way that the follower pin engages into the actuator's follower wheel (3).
6. Fasten the positioner onto the adapter bracket (4) using the fastening screws (6).

7. Mount the Type 3710 Reversing Amplifier (7) together with the two guide bushings (8) and terminal plate (9) onto the adapter bracket using the associated fastening screws (10).
→ Make sure that the seals are correctly seated.
8. Remove the vent plug at the adapter block and seal the opening with the G 1/4 screw plug.
9. Mount the turnboard marked '**Doppel**' for double-acting actuators or the turnboard marked '**PST**' for single-acting actuators with partial stroke testing. See Fig. 5-14.
→ Make sure that the seals are correctly seated.

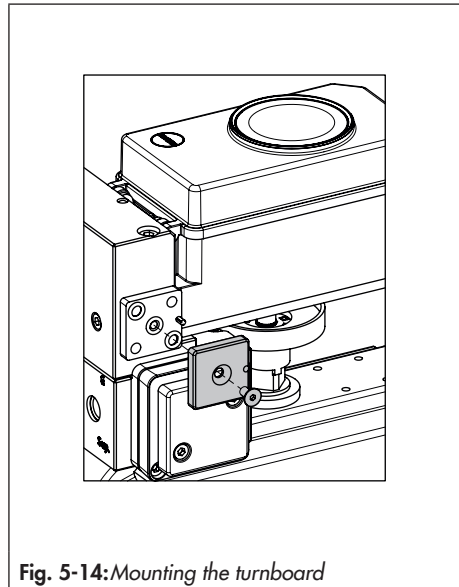
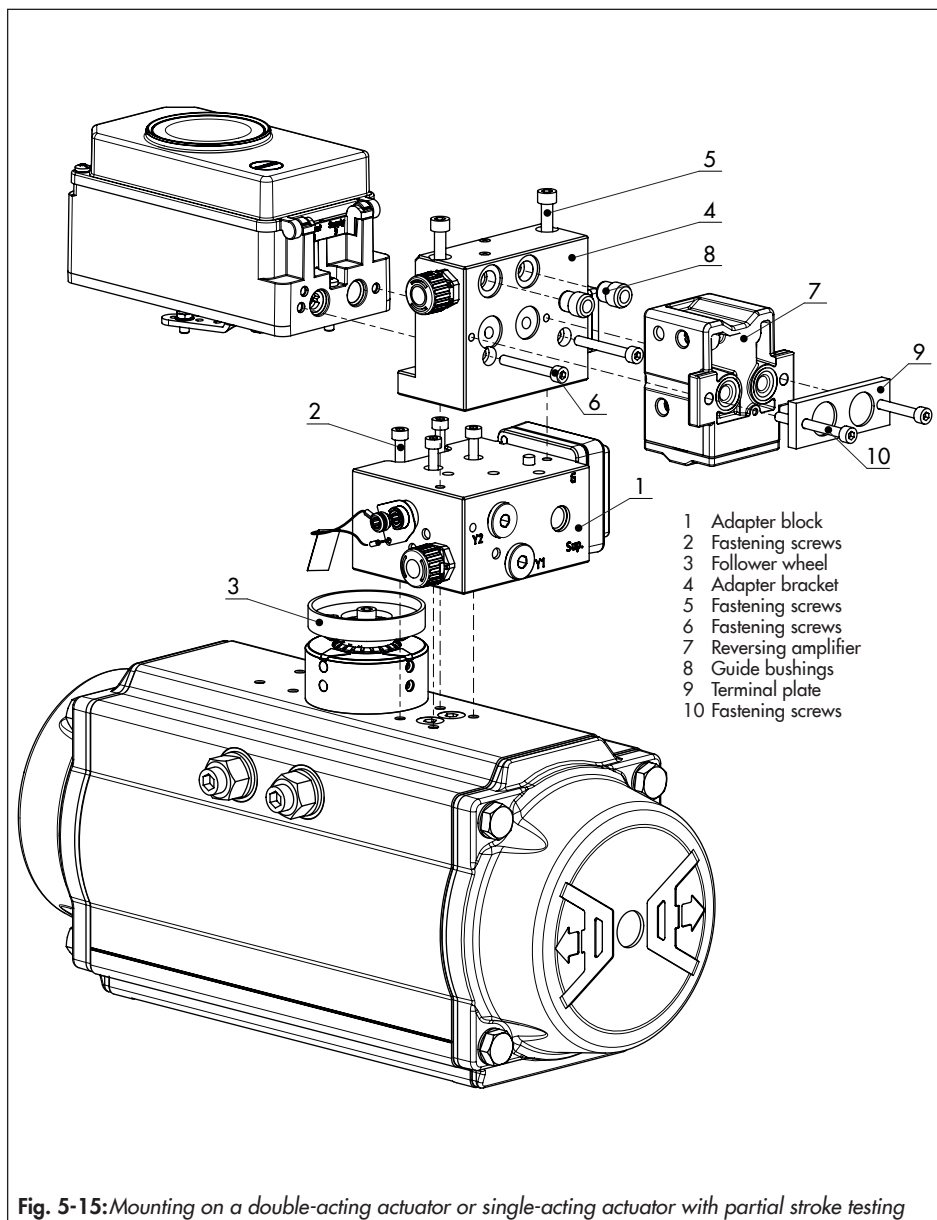

Fig. 5-14: Mounting the turnboard



Intermediate plate for AA4 interface

→ See Fig. 5-16

An intermediate plate (1) must be mounted between the adapter block and adapter bracket for PFEIFFER SRP and DAP rotary actuators in sizes 900 and 1200 with AA4 interface. This plate is included in the accessories for the shaft adapter AA4 (see Table 5-9).

Mounting a solenoid valve

→ See Fig. 5-17

A solenoid valve (12) can also be mounted in place of the dummy plate (12). The orientation of the turnboard (14) determines the mounting position of the solenoid valve. Alternatively, a restrictor plate can be mounted. Further information can be found in the document ► AB 11 (Accessories for Solenoid Valves).

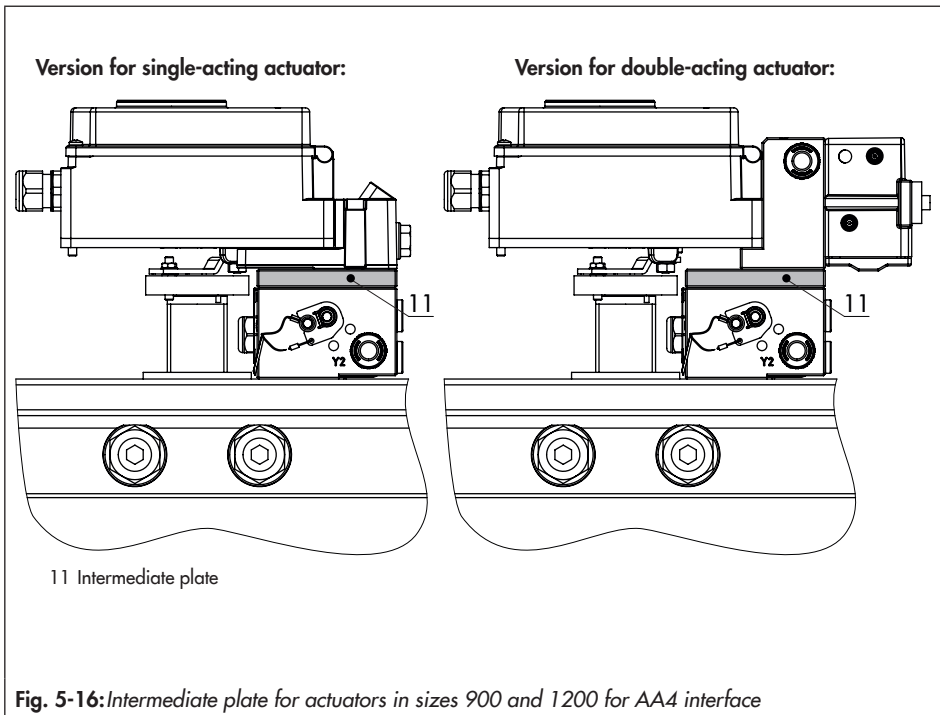

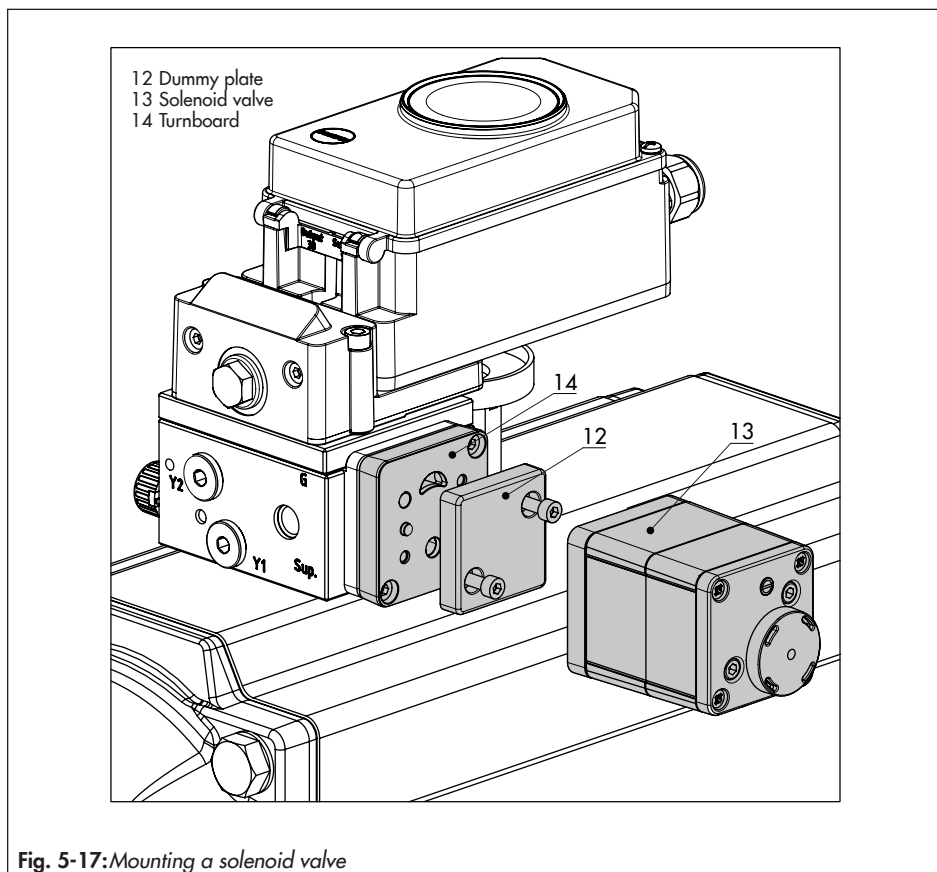

5.5.5 Attachment to Type 3510 Micro-flow Valve

- See Fig. 5-18
- Required mounting parts and accessories: Table 5-7
- Observe the travel table on page 5-5.

The positioner is attached to the valve yoke using a bracket.

1. Fasten the bracket (9.1) to the stem connector.
2. Screw the two bolts (9.2) to the bracket (9.1) of the stem connector (9), place the follower plate (3) on top and use the screws (9.3) for fastening.
3. Mount the travel indication scale (accessories) to the outer side of the yoke using the hex screws (12.1), ensuring that the scale is aligned with the stem connector.
4. Fasten the hex bar (11) onto the outer side of yoke by screwing the M8 screws (11.1) directly into the holes on the yoke.
5. Fasten the bracket (10) to the hex bar (11) using the hex screw (10.1), shim and tooth lock washer.
6. Mount connecting plate (6) or pressure gauge bracket (7) with pressure gauges on the positioner. Make sure that the two seals (6.1) are seated properly.
7. Unscrew the standard M lever (1) including follower pin (2) from the positioner shaft.

8. Take the S lever (1) and screw the follower pin (2) in the hole for pin position 17. Proceed as described as in section 5.4.
9. Place positioner on the bracket (10) in such a manner that the follower pin slides into the groove of the follower pin (3). Adjust the lever (1) correspondingly. Screw the positioner to the bracket (10) using both its screws.

5.5.6 Attachment to rotary actuators

- See Fig. 5-20
- Required mounting parts and accessories: Table 5-10
- Observe the travel table on page 5-5.

The positioner is mounted to the rotary actuator using two pairs of brackets.

Prior to attaching the positioner to the SAMSON Type 3278 Rotary Actuator, mount the associated adapter (5) to the free end of the rotary actuator shaft.

i Note

On mounting the positioner as described below, it is important to observe the actuator's direction of rotation.

1. Place follower clamp (3) on the slotted actuator shaft or adapter (5).

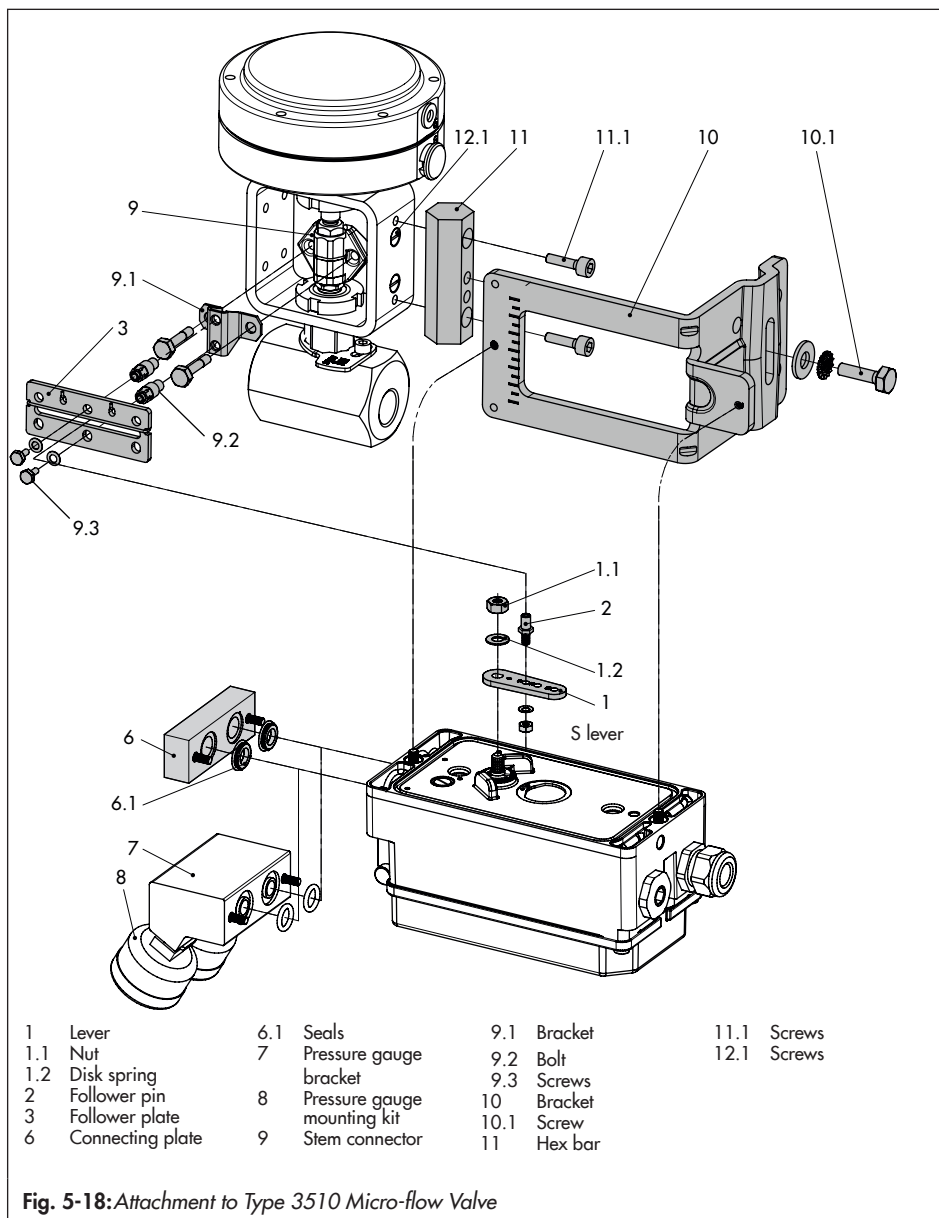

Installation

- Place coupling wheel (4) with flat side facing the actuator on the follower clamp (3). Align slot so that it matches the direction of rotation when the valve is in its closed position (see Fig. 5-20).
- Fasten the coupling wheel (4) and follower clamp (3) tightly onto the actuator shaft using screw (4.1) and disk spring (4.2).
- Fasten the bottom pair of brackets (10.1) with the bends pointing either facing to the inside or to the outside (depending on the actuator size) onto the actuator housing. Position the top pair of brackets (10) and fasten.
- Mount connecting plate (6) or pressure gauge bracket (7) with pressure gauges on the positioner. Make sure that the two seals (6.1) are seated properly. Double-acting springless rotary actuators require the use of a reversing amplifier on the connection side of the positioner housing (see section 5.5.7).
- Unscrew the standard follower pin (2) from the positioner's M lever (1). Use the metal follower pin (\varnothing 5 mm) included in the mounting kit and screw tight into the hole for pin position 90°.
- Place positioner on the top bracket (10) and fasten tight. Taking the actuator's direction of rotation into account, adjust lever (1) so that it engages in the slot of the coupling wheel (4) with its follower pin (Fig. 5-20). It must be guaranteed that the lever (1) is parallel to the long side of the positioner when the actuator is at half its angle of rotation.
- Stick the scale plate (4.3) on the coupling wheel so that the arrow tip indicates the closed position and it can be easily read when the valve is installed.

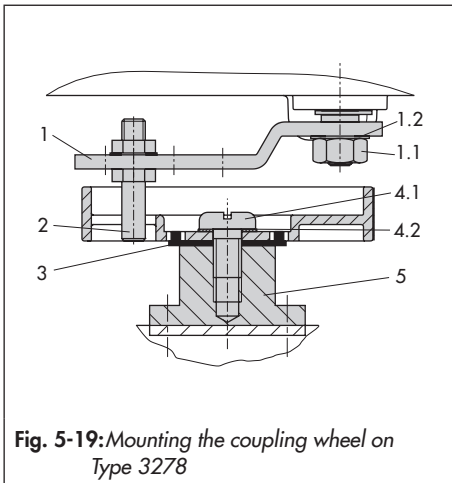
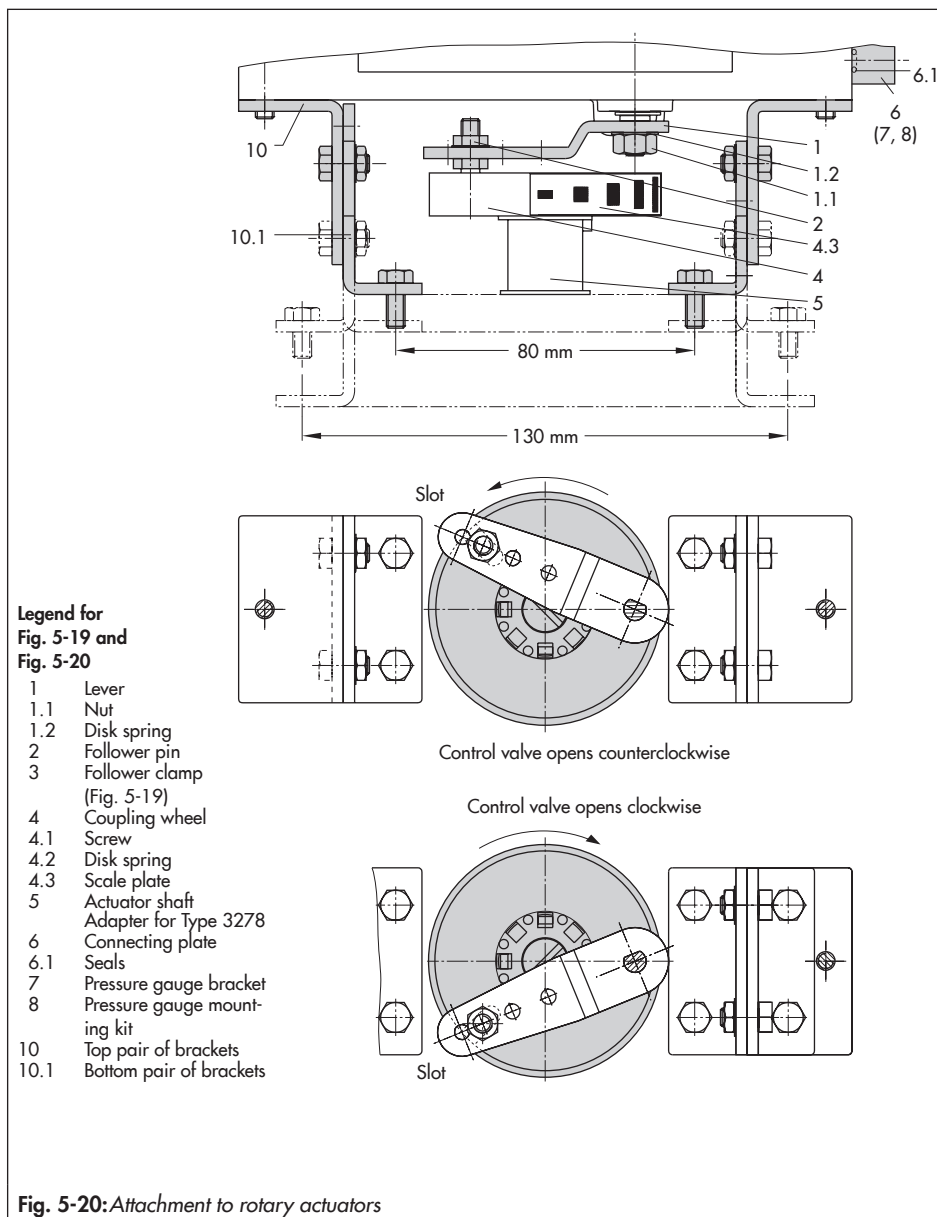

Fig. 5-19: Mounting the coupling wheel on Type 3278



a) Heavy-duty version

→ See Fig. 5-22

→ Required mounting parts and accessories: Table 5-10

Both mounting kits contain all the necessary mounting parts. The parts for the actuator size used must be selected from the mounting kit.

Prepare actuator and mount possibly required adapter supplied by the actuator manufacturer.

1. Mount the housing (10) onto the rotary actuator. In case of VDI/VDE attachment, place spacers (11) underneath, if necessary.
2. For **SAMSON Type 3278 and VETEC S160 Rotary Actuators**, fasten the adapter (5) onto the free end of the shaft and for **VETEC R Actuator**, place on the adapter (5.1). For **Type 3278**,

VETEC S160 and VETEC R Actuators, place on the adapter (3). For **Type 3278, VETEC S160 and VETEC R Actuators**, place on the adapter (3). For VDI/VDE version, this step depends on the actuator size.

3. Stick adhesive label (4.3) onto the coupling in such a manner that the yellow part of the sticker is visible in the window of the housing when the valve is OPEN. Adhesive labels with explanatory symbols are enclosed and can be stuck on the housing, if required.
4. Fasten coupling wheel (4) on the slotted actuator shaft or adapter (3) using screw (4.1) and disk spring (4.2).
5. Unscrew the standard follower pin (2) from the positioner's M lever (1). Attach the follower pin (Ø5 mm) included in the mounting kit to pin position 90°. Proceed as described in section 5.3.
6. Mount connecting plate (6) for required G 1/4 connecting thread or pressure gauge bracket (7) with pressure gauges on the positioner. Make sure that the two seals (6.1) are seated properly. Double-acting springless rotary actuators require the use of a reversing amplifier on the connection side of the positioner housing (see section 5.5.7).
7. For actuators with a volume of less than 300 cm³, screw the screw restriction (order no. 1400-6964) into the signal pressure output of the positioner (or the output of the pressure gauge bracket or connecting plate).

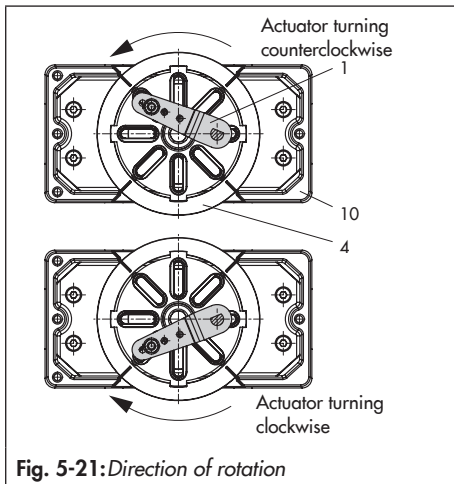

Fig. 5-21: Direction of rotation

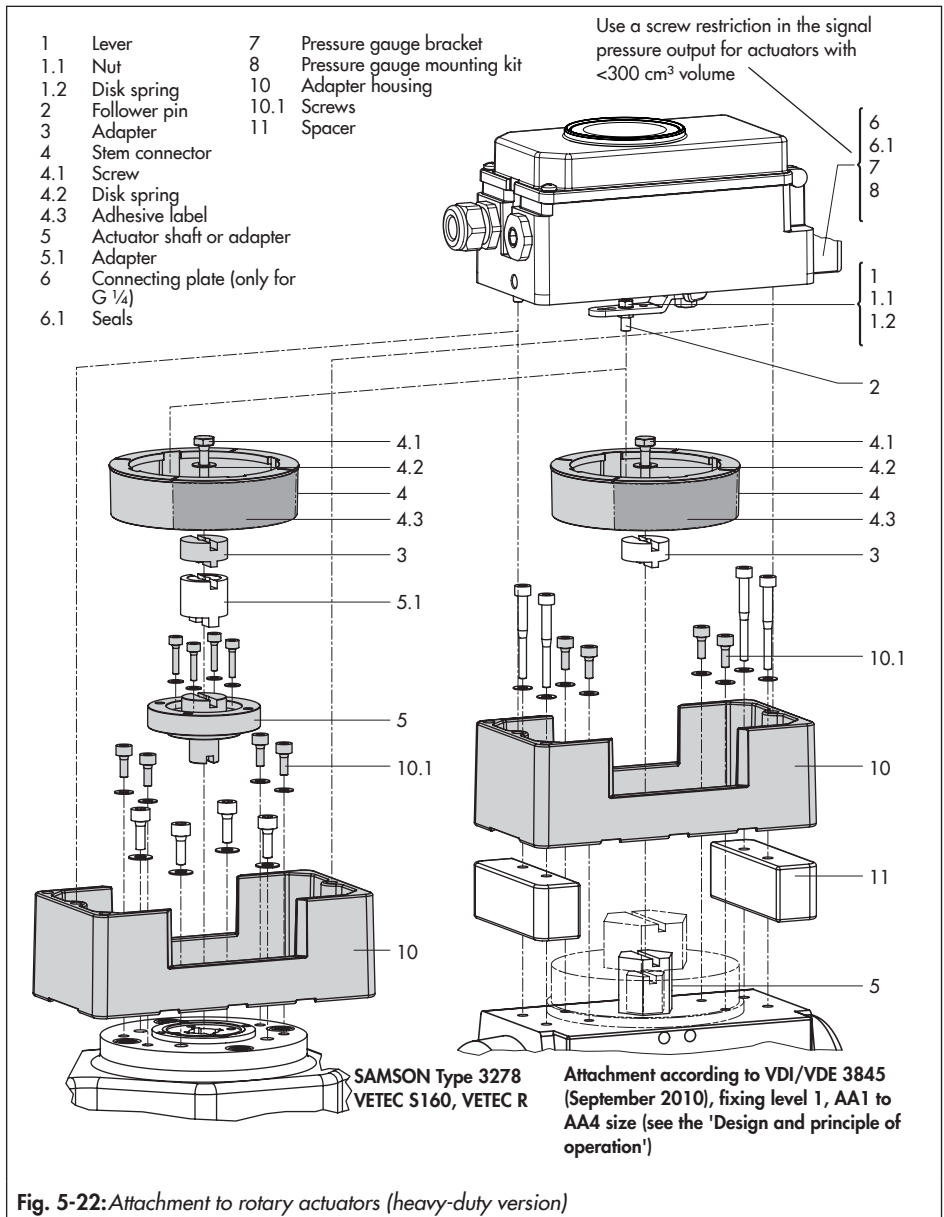

Fig. 5-22: Attachment to rotary actuators (heavy-duty version)

- Place positioner on housing (10) and screw it tight. Taking the actuator's direction of rotation into account, adjust lever (1) so that it engages in the correct slot with its follower pin (Fig. 5-21).

5.5.7 Reversing amplifier for double-acting actuators

For the use with double-acting actuators, the positioner must be fitted with a reversing amplifier, e.g. the SAMSON Type 3710 Reversing Amplifier (see Mounting and Operating Instructions ► EB 8392).

The following applies to all reversing amplifiers:

The signal pressure of the positioner is supplied at the output 1 of the reversing amplifier. An opposing pressure, which equals the required supply pressure (Z) when added to the pressure at output 1, is applied at output 2.

The following relationship applies:

output 1 + output 2 = Supply pressure (Z).

Connect output 1 to the signal pressure connection on the actuator that causes the valve to open when the pressure rises.

Connect output 2 to the signal pressure connection on the actuator that causes the valve to close when the pressure rises.

- ➔ Set slide switch on positioner to AIR TO OPEN.

i Note

How the outputs are marked depends on the reversing amplifier used. **Type 3710:** Output $1/2 = Y_1/Y_2$

5.6 Attachment of external position sensor

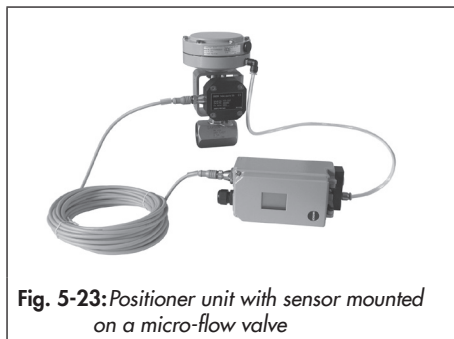

Fig. 5-23: Positioner unit with sensor mounted on a micro-flow valve

- ➔ Required mounting parts and accessories: Table 5-11

In the positioner version with an external position sensor, the sensor located in a separate housing is attached over a plate or bracket to the control valve. The travel pick-off corresponds to that of a standard device.

The positioner can be mounted as required to a wall or a pipe.

For the pneumatic connection either a connecting plate (6) or a pressure gauge bracket (7) must be fixed to the housing, depending on the accessory chosen. Make sure the seals (6.1) are correctly inserted (see Fig. 5-7, bottom right).

For the electrical connection a 10 meter connecting lead with M12x1 connectors is included in the scope of delivery.

i Note

- In addition, the instructions in sections 5.12 and 5.11 apply for the pneumatic and electrical connection.

Operation and setting are described in the 'Start-up and configuration' section.

- Since 2009, the back of the position sensor (20) is fitted with two pins acting as mechanical stops for the lever (1). If this position sensor is mounted using old mounting parts, two corresponding $\varnothing 8$ mm holes must be drilled into the mounting plate/bracket (21). A template is available for this purpose. See Table 5-11.

5.6.1 Mounting the position sensor with direct attachment

Type 3277-5 Actuator with 120 cm² (Fig. 5-24)

The signal pressure from the positioner is routed over the signal pressure connection of the connecting plate (9, Fig. 5-24 left) to the actuator diaphragm chamber. To proceed, first screw the connecting plate (9) included in the accessories onto the actuator yoke.

- Turn the connecting plate (9) so that the correct symbol for the fail-safe action "actuator stem extends" or "actuator stem retracts" is aligned with the marking (see Fig. 5-24, bottom).
 - ➔ Make sure that the gasket for the connecting plate (9) is correctly inserted.
- The connecting plate has threaded holes with NPT and G threads. Seal the threaded connection that is not used with the rubber seal and square plug.

Type 3277 Actuator with 175 to 750 cm²:

The signal pressure is routed to the connection at the side of the actuator yoke for the version with fail-safe action "actuator stem extends". For the fail-safe action "actuator stem retracts" the connection on the top diaphragm case is used. The connection at the side of the yoke must be fitted with a venting plug (accessories).

Mounting the position sensor

1. Place the lever (1) on the sensor in mid-position and hold it in place. Unthread the nut (1.1) and remove the lever together with the disk spring (1.2) from the sensor shaft.
2. Screw the position sensor (20) onto the mounting plate (21).
3. Depending on the actuator size and rated valve travel, determine which lever and position of the follower pin (2) is to be used from the travel table on page 5-5. The positioner is delivered with the **M** lever in pin position 35 on the sensor. If necessary, remove the follower pin (2) from its pin position and move it to the hole for the recommended pin position and screw tight.
4. Place the lever (1) and disk spring (1.2) on the sensor shaft. Place the lever **in mid-position** and **hold it in place**. Screw on the nut (1.1).
5. Place follower clamp (3) on the actuator stem, align it and screw tight so that the mounting screw is located in the groove of the actuator stem.

6. Place the mounting plate together with the sensor onto the actuator yoke so that the follower pin (2) rests on the top of the follower clamp (3). It must rest on it with spring force. Fasten the mounting plate (21) onto the actuator yoke using both fixing screws.
7. Mount cover (11) on the other side.
 - ➔ Make sure that the vent plug is located at the bottom when the control valve is installed to allow any condensed water that collects to drain off.

5.6.2 Mounting the position sensor with attachment according to IEC 60534-6

- ➔ See Fig. 5-25
 - ➔ Required mounting parts and accessories: Table 5-11
1. Place the lever (1) on the position sensor in **mid-position** and **hold it in place**. Unthread the nut (1.1) and remove the lever together with the disk spring (1.2) from the sensor shaft.

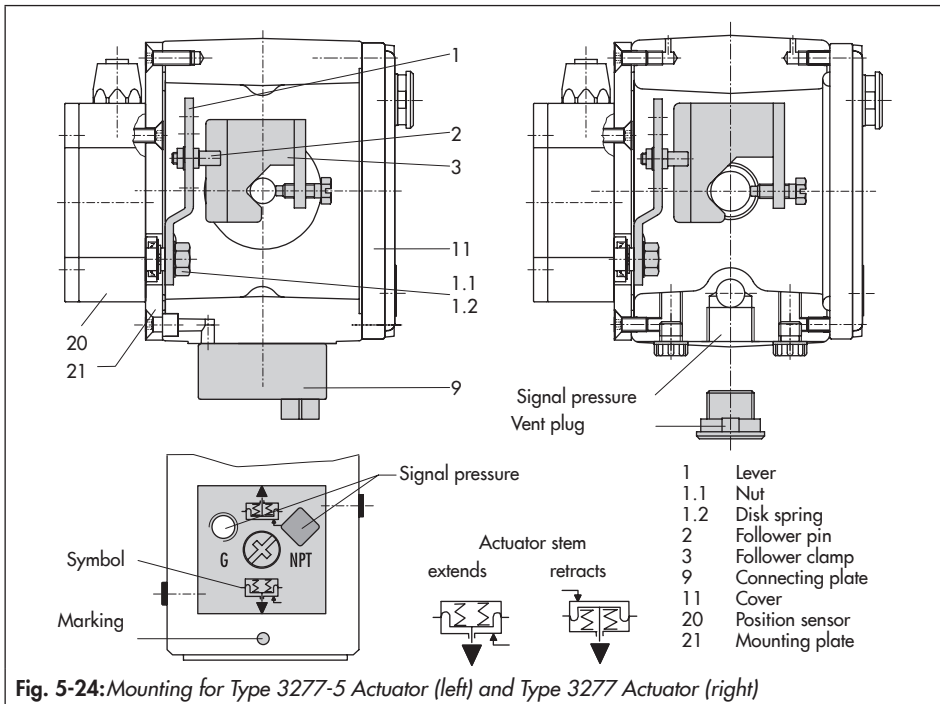

2. Screw the position sensor (20) onto the bracket (21).

The standard attached M lever with the follower pin (2) at position 35 is designed for 120 to 350 cm² actuators with 15 mm rated travel. For other actuator sizes or travels, select the lever and pin position from the travel table on page 5-5. L and XL levers are included in the mounting kit.

3. Place the lever (1) and disk spring (1.2) on the sensor shaft. Place the lever in **mid-position** and **hold it in place**. Screw on the nut (1.1).

4. Screw the two bolts (14) to the bracket (9.1) of the stem connector (9), place the follower plate (3) on top and use the screws (14.1) for fastening.
5. Place the bracket with the sensor at the NAMUR rib in such a manner that the follower pin (2) rests in the slot of the follower plate (3), then screw the bracket using its fixing screws onto the valve.

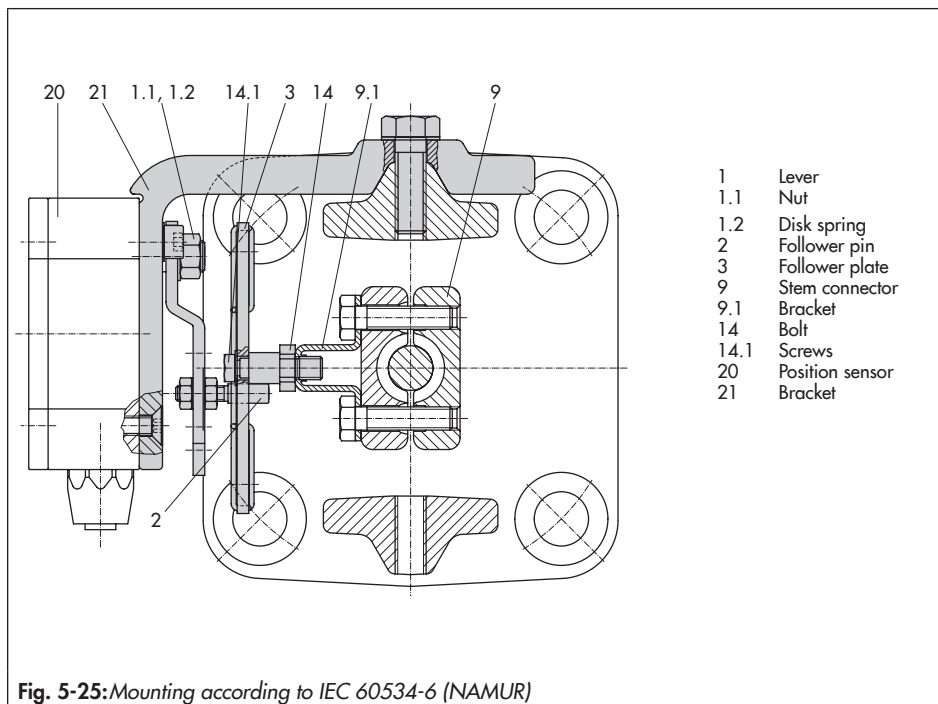

5.6.3 Mounting the position sensor to Type 3510 Micro-flow Valve

→ See Fig. 5-26

→ Required mounting parts and accessories: Table 5-11

1. Place the lever (1) on the position sensor in **mid-position** and **hold it in place**. Unscrew the nut (1.1) and remove the standard attached M lever (1) together with the disk spring (1.2) from the sensor shaft.
2. Screw the position sensor (20) onto the bracket (21).
3. Select the S lever (1) from the accessories and screw the follower pin (2) into the hole for pin position 17. Place the lever (1) and disk spring (1.2) on the sensor shaft. Place the lever in mid-position and hold it in place. Screw on the nut (1.1).
4. Place follower clamp (3) on the valve stem connector, align at a right angle and screw tight.
5. Position the bracket (21) with the position sensor on the valve yoke and screw tight, making sure the follower pin (2) slides into the groove of the follower clamp (3).

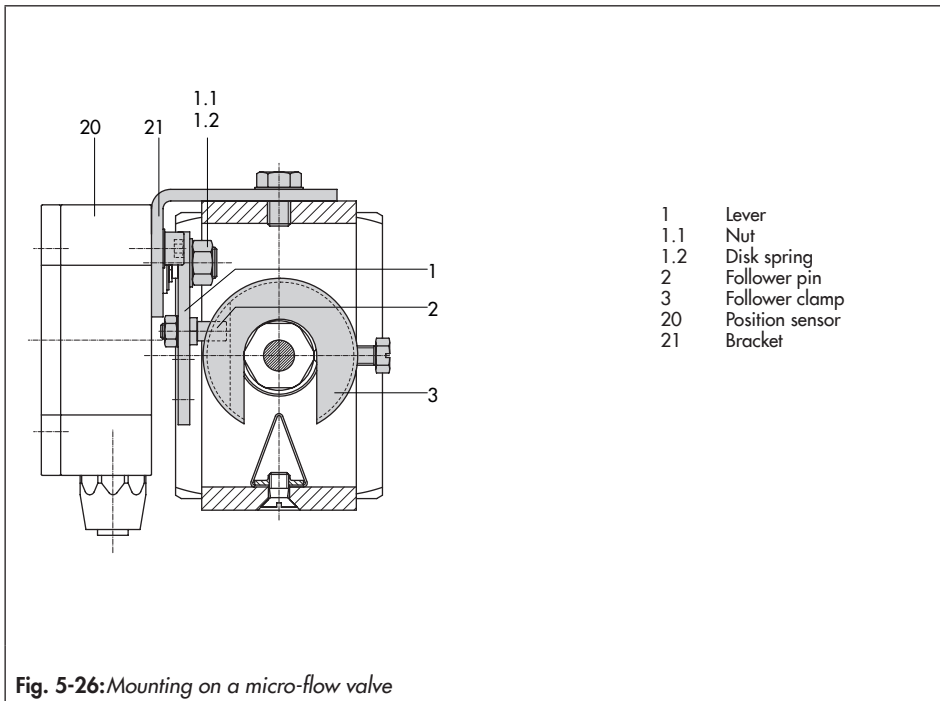

5.6.4 Mounting on rotary actuators

→ See Fig. 5-27

→ Required mounting parts and accessories: Table 5-11

1. Place the lever (1) on the position sensor in **mid-position** and **hold it in place**. Unthread the nut (1.1) and remove the lever together with the disk spring (1.2) from the sensor shaft.
2. Screw the position sensor (20) onto the mounting plate (21).

3. Replace the follower pin (2) normally attached to the lever (1) with the metal follower pin ($\varnothing 5$ mm) from the accessories and screw it into the hole for pin position 90° .
4. Place the lever (1) and disk spring (1.2) on the sensor shaft. Place the lever in **mid-position** and **hold it in place**. Screw on the nut (1.1).

Follow the instructions describing attachment to the standard positioner in section 5.5.6.

Instead of the positioner, attach the position sensor (20) with its mounting plate (21).

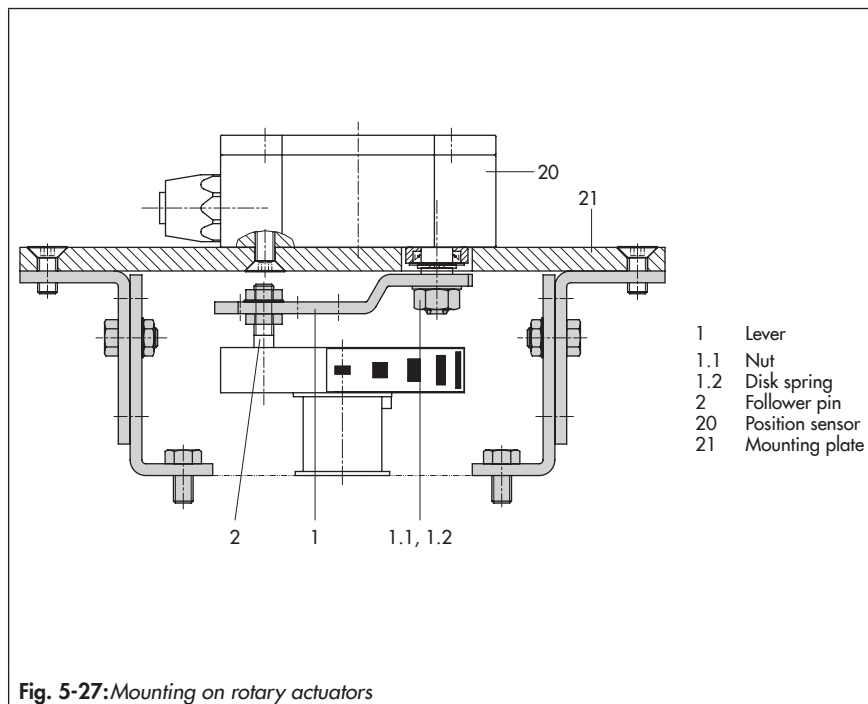

Fig. 5-27: Mounting on rotary actuators

5.7 Mounting the leakage sensor

→ See Fig. 5-28

Normally, the control valve is delivered with positioner and leakage sensor already mounted.

If the leakage sensor is mounted after the valve has been installed or it is mounted on another control valve, proceed as described in the following.

NOTICE

Risk of malfunction due to incorrect fastening.

Fasten the leakage sensor using a torque of 20 ± 5 Nm.

The M8 threaded connection on the NAMUR rib should preferably be used to mount the sensor (Fig. 5-28).

Tip

If the positioner was mounted directly onto the actuator (integral attachment), the NAMUR interfaces on either side of the valve yoke can be used to mount the leakage sensor.

The start-up of the leakage sensor is described in detail in the Operating Instructions for EXPERTplus Valve Diagnostics.

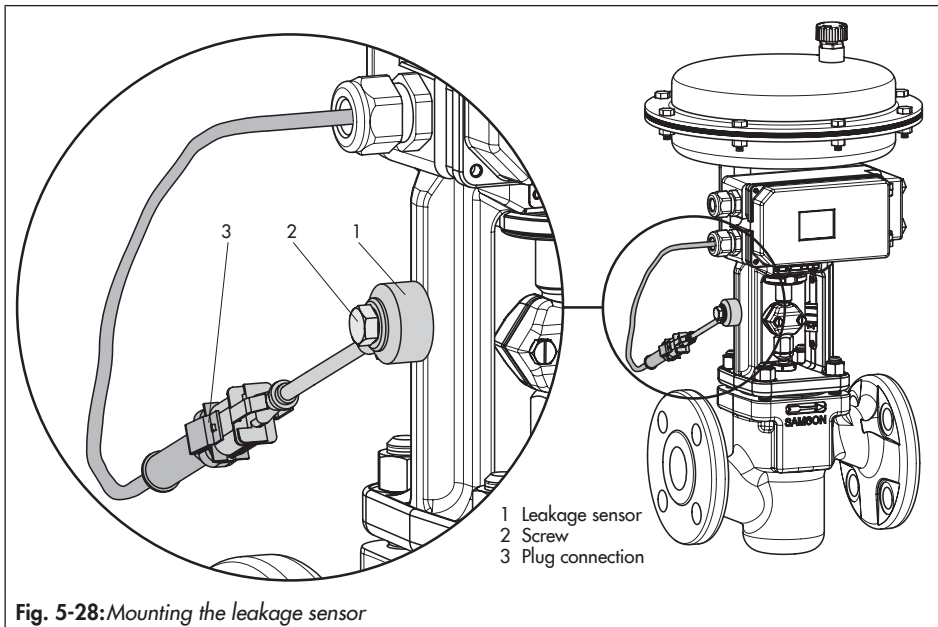

Fig. 5-28: Mounting the leakage sensor

5.8 Retrofitting inductive limit switch

Required retrofit kit:

Limit switch Order no. 1402-1770

i Note

The same requirements apply to retrofitting a unit as to servicing the positioner. For explosion-protected positioners, the requirements specified under 'Servicing explosion-protected devices' in the 'Safety instructions and measures' section must be observed. Check the "Limit switch, inductive" box on the nameplate after installing the limit switch.

1. Remove rotary pushbutton (3) and cap (1), unthread the five fastening screws (2) and lift off plastic cover (9) together with the display, taking care not to damage the ribbon cable (between PCB and display).
2. Use a knife to cut an opening at the marked location (4).
3. Push the connector (11) with cable through the opening and secure the proximity switch (7) on the cover with a dot of glue.
4. If necessary, remove the jumper at the socket X9 and push the cable connector (11) on the socket.
5. Guide the cable in such a manner that the plastic cover can be placed back onto the positioner. Insert the fixing screws (2) and screw tight. Attach the clamping plate (8) onto the proximity switch.

6. Attach the rotary switch (5). Make sure the flattened side of the positioner shaft is turned so that the rotary switch (5) can be attached with the metal tag next to the proximity switch.
7. On start-up of the positioner, set the option inductive alarm under Code 38 from No to YES.

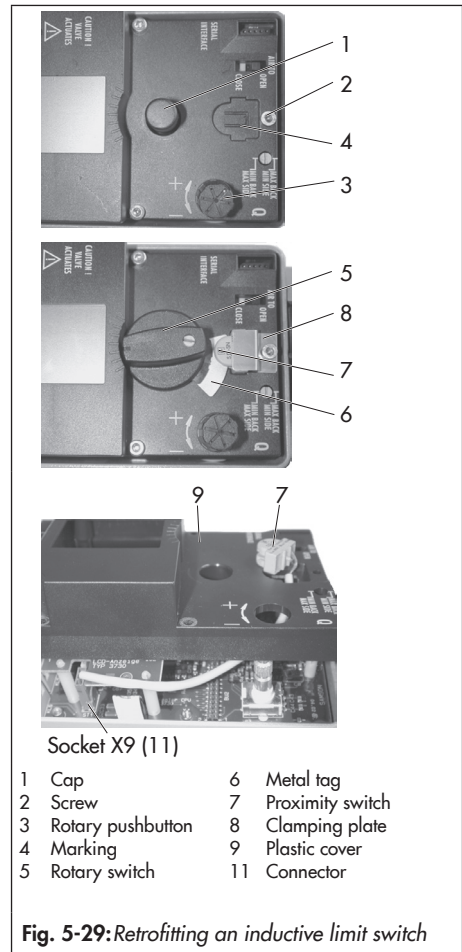

Fig. 5-29: Retrofitting an inductive limit switch

5.9 Mounting positioners with stainless steel housings

Positioners with stainless steel housings require mounting parts that are completely made of stainless steel or free of aluminum.

i Note

The pneumatic connecting plate and pressure gauge bracket are available in stainless steel (order numbers listed below). The Type 3710 Pneumatic Reversing Amplifier is also available in stainless steel.

Connecting plate (stainless steel)	G 1/4 1/4 NPT	1400-7476 1400-7477
Pressure gauge bracket (stainless steel)	G 1/4 1/4 NPT	1402-0265 1400-7108

Table 5-4 to Table 5-10 apply for attaching positioners with stainless steel housings with the following restrictions:

Direct attachment

All mounting kits from Table 5-6 can be used. The connection block is not required. The stainless steel version of the pneumatic connecting plate routes the air internally to the actuator.

Attachment according to IEC 60534-6 (NAMUR rib or attachment to rod-type yokes)

All mounting kits from Table 5-7 can be used. Connecting plate in stainless steel.

Attachment to rotary actuators

All mounting kits from Table 5-10 can be used except for the heavy-duty version. Connecting plate in stainless steel.

5.10 Air purging function for single-acting actuators

The instrument air leaving the positioner is diverted to the actuator spring chamber to provide corrosion protection inside the actuator. Observe the following:

Direct attachment to Type 3277-5 (stem extends FA/stem retracts FE)

The air purging function is automatically provided.

Direct attachment to Type 3277, 175 to 750 cm²

FA: Remove the stopper (12.2, Fig. 5-6) at the black connection block and make a pneumatic connection to the spring chamber on the vented side.

! NOTICE

Mounting possibly incorrect when old powder-paint-coated aluminum connection blocks are used.

Mount old powder-paint-coated aluminum connection blocks as described in 'Attachment according to IEC 60534-6 (NAMUR rib or attachment to rod-type yokes)' and 'Attachment to rotary actuators'.

FE: The air purging function is automatically provided.

Attachment according to IEC 60534-6 (NAMUR rib or attachment to rod-type yokes) and to rotary actuators

The positioner requires an additional port for the exhaust air that can be connected over piping. An adapter available as an accessory is used for this purpose:

Threaded bush-	G ¼	0310-2619
ing (M20x1.5)	¼ NPT	0310-2550

i Note

The adapter uses one of the M20x1.5 connections in the housing which means only one cable gland can be installed.

Should other valve accessories be used which vent the actuator (e.g. solenoid valve, volume booster, quick exhaust valve), this exhaust air must also be included in the purging function. The connection over the adapter at the positioner must be protected with a check valve (e.g. check valve G ¼, order no. 8502-0597) mounted in the piping. Otherwise the pressure in the positioner housing would rise above the ambient pressure and damage the positioner when the exhausting components respond suddenly.

5.11 Pneumatic connection

⚠ WARNING

Risk of injury by possible movement of exposed parts (positioner, actuator or valve) after connecting the signal pressure.

→ Do not touch or block exposed moving parts.

ⓘ NOTICE

Incorrect connection of the supply air will damage the positioner and will lead to malfunction.

→ Screw the screw fittings (Supply and Output) into the connecting plate, pressure gauge mounting block or connection block from the accessories.

→ Never screw threaded parts directly into housing.

The pneumatic ports are located on the back of the positioner (see Fig. 5-30).

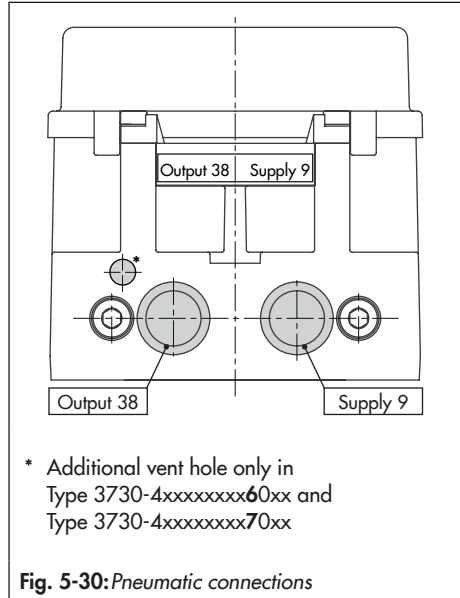

* Additional vent hole only in
Type 3730-4xxxxxxxx60xx and
Type 3730-4xxxxxxxx70xx

Fig. 5-30: Pneumatic connections

Connecting the supply air

Before performing the pneumatic connection, make sure the following conditions are met:

- The positioner is properly mounted onto the control valve.

If this is the case:

→ Connect the pneumatic connections in the connecting plate, pressure gauge mounting block and connection block (optionally designed as a bore with ¼ NPT or G ¼ thread). Customary fittings for metal or copper tubing or plastic hoses can be used.

5.11.1 Signal pressure connection

The signal pressure connection depends on how the positioner is mounted onto the actuator:

Type 3277 Actuator

- The signal pressure connection is fixed.

Attachment according to IEC 60534-6 (NAMUR)

- For "actuator stem retracts" fail-safe action: connect the signal pressure to the connection on top of the actuator.
- For "actuator stem extends" fail-safe action: connect the signal pressure to the connection on bottom of the actuator.

Rotary actuators

- For rotary actuators, the manufacturer's specifications for connection apply.

5.11.2 Signal pressure reading



To monitor the supply air and signal pressure, we recommend mounting pressure gauges (see accessories in section 5.13).

Mounting the pressure gauges:

- See section 5.2 and Fig. 5-7

5.11.3 Supply pressure

The required supply air pressure depends on the bench range and the actuator's direction of action (fail-safe action).

The bench range is written on the nameplate either as the bench range or signal pressure range depending on the actuator. The direction of action is marked FA or FE or by a symbol.

Actuator stem extends FA (AIR TO OPEN)

Fail-close (for globe and angle valves):

- Required supply pressure = Upper bench range value + 0.2 bar, at least 1.4 bar.

Actuator stem retracts FE (AIR TO CLOSE)

Fail-open (for globe and angle valves):

For tight-closing valves, the maximum signal pressure pst_{max} is roughly estimated as follows:

$$pst_{max} = F + \frac{d^2 \cdot \pi \cdot \Delta p}{4 \cdot A} \text{ [bar]}$$

d = Seat diameter [cm]

Δp = Differential pressure across the valve [bar]

A = Actuator area [cm²]

F = Upper bench range value of the actuator [bar]

If there are no specifications, calculate as follows:

- Required supply pressure = Upper bench range value + 1 bar

5.11.4 Signal pressure (output)

The signal pressure at the output (38) of the positioner can be restricted to 1.4 bar, 2.4 bar or 3.7 bar in Code 16.

The limitation is not activated by default [No].

5.12 Electrical connection

For electrical installation, observe the relevant electrotechnical regulations and the accident prevention regulations that apply in the country of use. In Germany, these are the VDE regulations and the accident prevention regulations of the employers' liability insurance.

⚠ WARNING

Incorrect electrical connection will render the explosion protection unsafe.

- Adhere to the terminal assignment.
 - Do not undo the enameled screws in or on the enclosure.
-

⚠ WARNING

Intrinsic safety rendered ineffective in intrinsically safe devices.

- Only connect intrinsically safe devices intended for use in intrinsically safe circuits to certified intrinsically safe input-connected units.
 - Do not place intrinsically safe devices back into operation that were connected to intrinsically safe input-connected units without certification.
 - Do not exceed the maximum permissible electric values specified in the EC type examination certificates when interconnecting intrinsically safe electrical equipment (U_i or U_o , I_i or I_o , P_i or P_o , C_i or C_o and L_i or L_o).
-

The ambient temperature ranges of the tables in the EC type examination certificate apply for the assignment between the permissible ambient temperature, temperature class, maximum short-circuit currents and maximum power P_i and P_o .

The following additionally applies: For positioners in type of protection Ex tb (3730-4 5) and type of protection Ex nA (3730-4 8), the cable glands and blanking plugs must be certified according to EN 60079-7 (Ex e).

Selecting cables and wires

- Observe **Clause 12 of EN 60079-14** for installation of the intrinsically safe circuits.

Clause 12.2.2.7 applies when running multi-core cables or wires with more than one intrinsically safe circuit.

The radial thickness of the insulation of a conductor for common insulating materials (e.g. polyethylene) must not be smaller than 0.2 mm. The diameter of an individual wire in a fine-stranded conductor must not be smaller than 0.1 mm. Protect the conductor ends against splicing, e.g. by using wire-end ferrules.

When two separate cables or wires are used for connection, an additional cable gland can be installed. Seal cable entries left unused with plugs. Fit equipment used in ambient temperatures below -20 °C with metal cable entries

Equipment for use in zone 2/zone 22

In equipment operated according to type of protection Ex nA (non-sparking equipment) according to EN 60079-15, circuits may be connected, interrupted or switched while energized only during installation, maintenance or repair.

The special conditions of use mentioned in the statement of conformity must be observed for the rated values and the installation of the series-connected fuse for interconnection of Ex nA circuits.

For Ex nA equipment (non-sparking equipment), circuits may be connected, interrupted or switched while energized only during installation, maintenance or repair.

- Positioners with type of protection Ex nA or Ex tc can be used with a cover with or without window.
- The Type 3730-41, Type 3730-45 and Type 3730-48 Positioners are 100 % identical in design, except for the marking and the housing cover.
- For type of protection Ex nA, the VCC connection in the interface adapter must be connected in series with a fuse according to IEC 60127, 250 V F or T with a fuse rating of $I_N \leq 40$ mA.

The fuses must be installed outside the hazardous area.

Cable entry

Cable entry with M20x1.5 cable gland, 6 to 12 mm clamping range (see accessories in Table 5-4).

There is a second M20x1.5 threaded hole in the housing that can be used for additional connection, when required. The screw terminals are designed for wire cross-sections of 0.2 to 2.5 mm². Tighten the screws by 0.5 to 0.6 Nm.

i Note

The power supply for the positioner can be supplied either over the connection to the fieldbus segment or over a DC voltage source (9 to 32 V) connected to the bus terminals in the positioner.

Observe the relevant regulations for installation in hazardous areas.

Installation

Bus line

Route the two-wire bus line to the screw terminals marked "IEC 1158-2", whereby no polarity needs to be observed.

To connect the limit switch, binary inputs and solenoid valve, an additional cable gland that needs to be fitted in place of the existing blanking plug is necessary.

NOTICE

Degree of protection may be impaired.

- ➔ Seal cable glands left unused with blanking plugs.
- ➔ Close the housing cover to obtain the IP 66 degree of protection.

Refer to the PROFIBUS-PA User and Installation Guide (PNO document 2.092) for more information.

Limit switch

The operation of the limit switch requires a switching amplifier to be connected in the output circuit. Its function is to control the limit values of the control circuit according to EN 60947-5-6, thus ensuring operational reliability of the positioner.

Observe the relevant regulations for installation in hazardous areas.

Binary input BI1

An active contact can be operated at binary input 1. The positioner can report the switching state over the bus protocol.

Binary input BI2

A passive, floating contact can be operated at binary input 2. The positioner can report the switching state over the bus protocol.

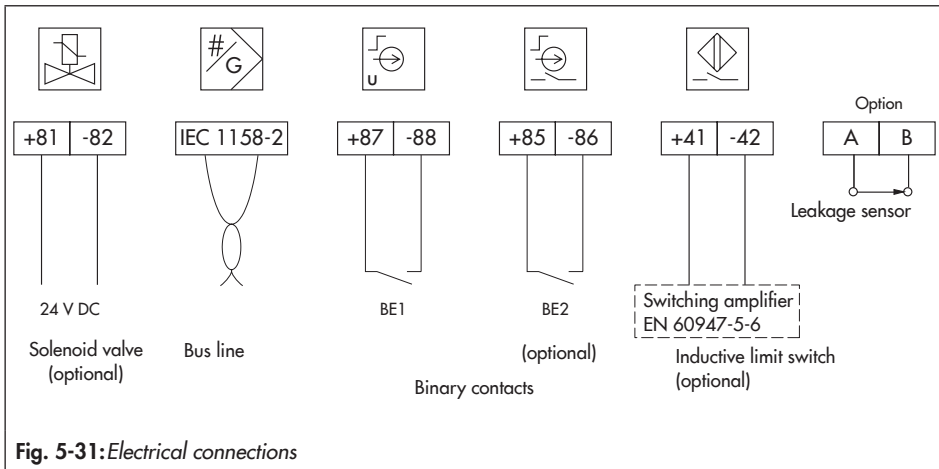

Fig. 5-31: Electrical connections

Solenoid valve

For positioners fitted with the optional solenoid valve for the forced venting function, a voltage of 24 V DC must be connected to the relevant terminals +81 and –82.

If there is no voltage connected for the solenoid valve at terminals +81 and –82 or when the voltage signal is interrupted, the positioner vents the actuator.

! NOTICE

The actuator does not respond to the set point when the voltage is too low. Observe the switching thresholds specified in the technical data.

5.12.1 Switching amplifier according to EN 60947-5-6

For operation of the limit switches, switching amplifiers must be connected in the output circuit. They must comply with the limit values of the output circuits conforming to EN 60947-5-6.

→ Observe the relevant regulations for installation in hazardous areas.

For applications in safe areas (non-hazardous areas), limit switches can be directly interconnected to the binary input of the PLC in accordance with IEC 61131. This applies to the standard operating range for digital inputs according to Clause 5.2.1.2 of IEC 61131-2 with the rated voltage of 24 V DC.

5.12.2 Establishing communication

The communication structure between the controller, logic solvers (PLC) or automation system or between a computer or work station and the positioner(s) is implemented using a segment coupler (see Fig. 5-32) according to the PROFIBUS guidelines.

Explosion-protected versions of PROFIBUS-PA segment couplers must be used in hazardous areas.

A maximum of 32 positioners can be operated in parallel over a segment coupler in one PROFIBUS-PA segment. In hazardous areas, the number of positioners that can be connected is reduced.

Each positioner connected in the segment must be assigned a unique bus address between 0 and 125 (see the 'Start-up and configuration' section).

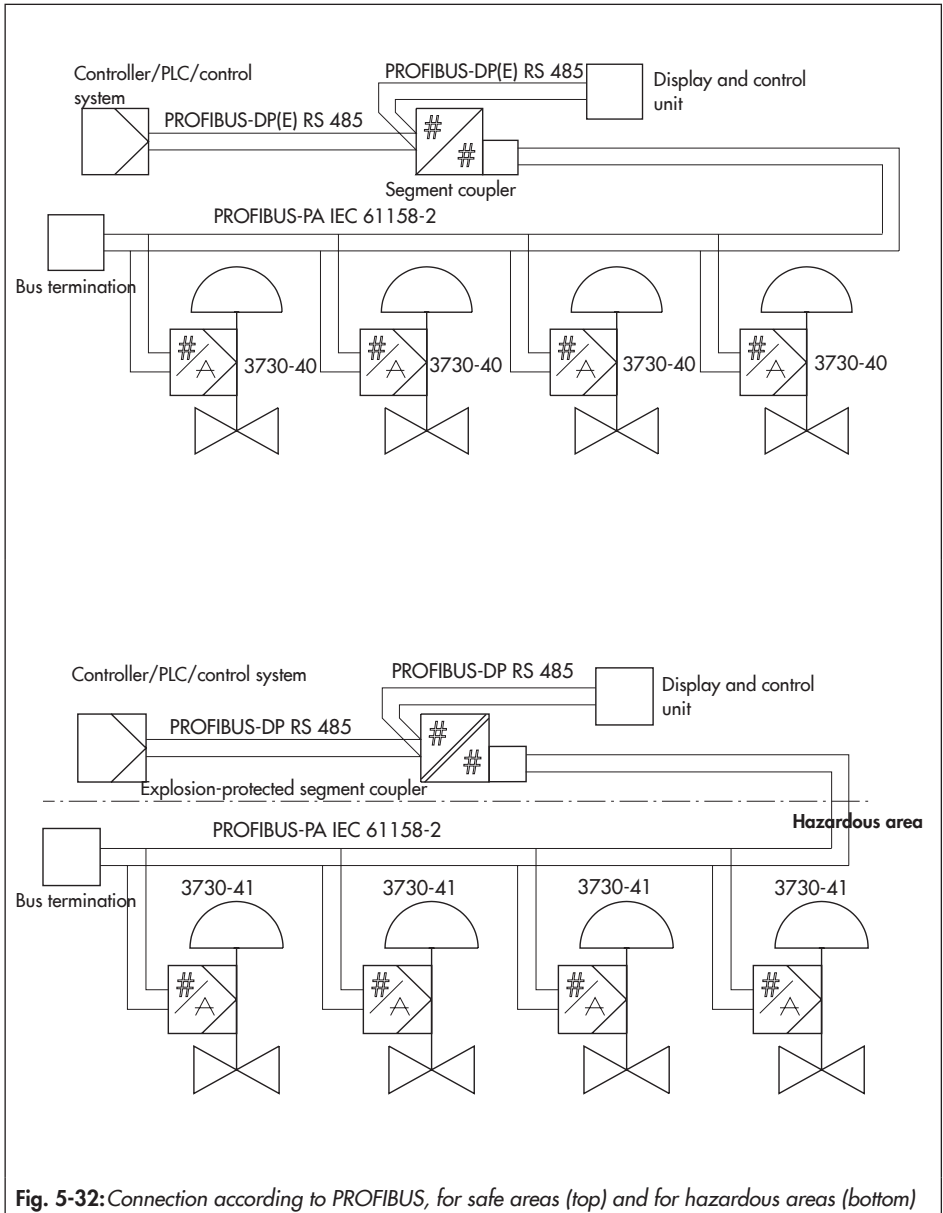

Fig. 5-32: Connection according to PROFIBUS, for safe areas (top) and for hazardous areas (bottom)

5.13 Mounting accessories

Table 5-4: *General accessories*

Designation		Order no.
Reversing amplifier for double-acting actuators		Type 3710
M20x1.5 cable gland	Black plastic (6 to 12 mm clamping range)	8808-1011
	Blue plastic (6 to 12 mm clamping range)	8808-1012
	Nickel-plated brass (6 to 12 mm clamping range)	1890-4875
	Nickel-plated brass (10 to 14 mm clamping range)	1992-8395
	Stainless steel 1.4305 (8 to 14.5 mm clamping range)	8808-0160
Adapter M20x1.5 to ½ NPT	Powder-coated aluminum	0310-2149
	Stainless steel	1400-7114
Lever	S	0510-0522
	M	0510-0510
	L	0510-0511
	XL	0510-0512
	XXL	0510-0525
Retrofit kit for inductive limit switch 1 x SJ2-SN		1402-1770
Isolated USB interface adapter (SSP interface to USB port on a computer) including TROVIS-VIEW CD-ROM		1400-9740
TROVIS-VIEW 6661 (▶ www.samsongroup.com > SERVICE & SUPPORT > Downloads > TROVIS-VIEW)		

Table 5-5: *Direct attachment to Type 3277-5 Actuator*

Designation		Order no.	
Mounting parts	Standard version for actuators 120 cm ² or smaller	1400-7452	
	Version compatible with paint for actuators 120 cm ² or smaller	1402-0940	
Accessories for actuator	Old switchover plate for Type 3277-5xxxxxx. 00 Actuator (old)	1400-6819	
	New switchover plate for Type 3277-5xxxxxx. 01 Actuator (new) ¹⁾	1400-6822	
	New connecting plate for Type 3277-5xxxxxx. 01 Actuator (new) ¹⁾ , G ¼ and ½ NPT	1400-6823	
	Old connecting plate for Type 3277-5xxxxxx. 00 Actuator (old): G ¼	1400-6820	
	Old connecting plate for Type 3277-5xxxxxx. 00 (old): ½ NPT	1400-6821	
Accessories for positioner	Connecting plate (6)	G ¼	1400-7461
		¼ NPT	1400-7462
	Pressure gauge bracket (7)	G ¼	1400-7458
		¼ NPT	1400-7459
	Pressure gauge mounting kit (8) up to max. 6 bar	Stainless steel/brass	1402-1637
		Stainless steel/stainless steel	1402-1638

¹⁾ Only new switchover and connecting plates can be used with new actuators (Index 01). Old and new plates are not interchangeable.

Table 5-6: Direct attachment to Type 3277 Actuator

Mounting parts/accessories		Order no.
Standard version for actuators 175, 240, 350, 355, 700, 750 cm ²		1400-7453
Version compatible with paint for actuators 175, 240, 350, 355, 700, 750 cm ²		1402-0941
Connection block with seals and screw	G 1/4	1400-8819
	1/4 NPT	1402-0901
Pressure gauge mounting kit up to max. 6 bar (output/supply)	Stainless steel/brass	1402-1637
	Stainless steel/stainless steel	1402-1638
Piping with screw fittings ¹⁾		Order no.
Actuator (175 cm ²), steel	G 1/4/G 3/8	1402-0970
	1/4 NPT/3/8 NPT	1402-0976
Actuator (175 cm ²), stainless steel	G 1/4/G 3/8	1402-0971
	1/4 NPT/3/8 NPT	1402-0978
Actuator (240 cm ²), steel	G 1/4/G 3/8	1400-6444
	1/4 NPT/3/8 NPT	1402-0911
Actuator (240 cm ²), stainless steel	G 1/4/G 3/8	1400-6445
	1/4 NPT/3/8 NPT	1402-0912
Actuator (350 cm ²), steel	G 1/4/G 3/8	1400-6446
	1/4 NPT/3/8 NPT	1402-0913
Actuator (350 cm ²), stainless steel	G 1/4/G 3/8	1400-6447
	1/4 NPT/3/8 NPT	1402-0914
Actuator (355 cm ²), steel	G 1/4/G 3/8	1402-0972
	1/4 NPT/3/8 NPT	1402-0979
Actuator (355 cm ²), stainless steel	G 1/4/G 3/8	1402-0973
	1/4 NPT/3/8 NPT	1402-0980
Actuator (700 cm ²), steel	G 1/4/G 3/8	1400-6448
	1/4 NPT/3/8 NPT	1402-0915
Actuator (700 cm ²), stainless steel	G 1/4/G 3/8	1400-6449
	1/4 NPT/3/8 NPT	1402-0916
Actuator (750 cm ²), steel	G 1/4/G 3/8	1402-0974
	1/4 NPT/3/8 NPT	1402-0981
Actuator (750 cm ²), stainless steel	G 1/4/G 3/8	1402-0975
	1/4 NPT/3/8 NPT	1402-0982

¹⁾ for "actuator stem retracts" fail-safe action
with air purging of the top diaphragm chamber

Table 5-7: Attachment to NAMUR rib or attachment to rod-type yokes ¹⁾ according to IEC 60534-6

Travel in mm	Lever	For actuator	Order no.
7.5	S	Type 3271-5 with 60/120 cm ² on Type 3510 Micro-flow Valve	1402-0478
5 to 50	M ²⁾	Actuators from other manufacturers and Type 3271 with 120 to 750 cm ² effective areas	1400-7454
14 to 100	L	Actuators from other manufacturers and Type 3271 with 1000 and 1400-60 cm ²	1400-7455
30 or 60	L	Type 3271, 1400-120 and 2800 cm ² versions with 30/60 mm travel ³⁾	1400-7466
		Mounting brackets for Emerson and Masoneilan linear actuators (in addition, a mounting kit according to IEC 60534-6 is required depending on the travel). See rows above.	1400-6771
		Valtek Type 25/50	1400-9554
40 to 200	XL	Actuators from other manufacturers and Type 3271 with 1400-120 and 2800 cm ² and with 120 mm travel	1400-7456
Accessories			Order no.
Connecting plate	G ¼		1400-7461
	¼ NPT		1400-7462
Pressure gauge bracket	G ¼		1400-7458
	¼ NPT		1400-7459
Pressure gauge mounting kit up to max. 6 bar	Stainless steel/brass		1402-1637
	Stainless steel/stainless steel		1402-1638

¹⁾ 20 to 35 mm rod diameter

²⁾ M lever is mounted on basic device (included in the scope of delivery)

³⁾ In conjunction with Type 3273 Side-mounted Handwheel with 120 mm rated travel, additionally one bracket (0300-1162) and two countersunk screws (8330-0919) are required.

Table 5-8: Attachment according to VDI/VDE 3847-1

Mounting parts	Order no.		
VDI/VDE 3847 interface adapter	1402-0257		
Connecting plate, including connection for air purging of actuator spring chamber	Aluminum	ISO 228/1-G ¼	1402-0268
		¼-18 NPT	1402-0269
	Stainless steel	ISO 228/1-G ¼	1402-0270
		¼-18 NPT	1402-0271
Mounting kit for attachment to SAMSON Type 3277 Actuator with 175 to 750 cm ²	1402-0868		
Mounting kit for attachment to SAMSON Type 3271 Actuator or third-party actuators	1402-0869		
Travel pick-off for valve travel up to 100 mm	1402-0177		
Travel pick-off for 100 to 200 mm valve travel (SAMSON Type 3271 Actuator only)	1402-0178		

Table 5-9: Attachment according to VDI/VDE 3847-2

Designation		Order no.
Mounting parts	Mounting block for PFEIFFER Type 31a (edition 2020+) Rotary Actuators with blank plate for solenoid valve interface	1402-1645
	Dummy plate for solenoid valve interface (sold individually)	1402-1290
	Adapter bracket for Type 3730 (VDI/VDE 3847)	1402-0257
	Adapter bracket for Type 3730 and Type 3710 (DAP/PST)	1402-1590
Accessories for actuator	Shaft adapter AA1	1402-1617
	Shaft adapter AA2	1402-1616
	Shaft adapter AA4	1402-1888

Table 5-10: Attachment to rotary actuators

Mounting parts/accessories		Order no.	
Attachment according to VDI/VDE 3845 (September 2010), actuator surface corresponds to fixing level 1			
	Size AA1 to AA4, version with CrNiMo steel bracket	1400-7448	
	Size AA1 to AA4, heavy-duty version	1400-9244	
	Size AA5, heavy-duty version (e.g. Air Torque 10 000)	1400-9542	
	Bracket surface corresponds to fixing level 2, heavy-duty version	1400-9526	
	Attachment for rotary actuators with max. 180° opening angle, fixing level 2	1400-8815 and 1400-9837	
Attachment to SAMSON Type 3278 with 160/320 cm ² , CrNiMo steel bracket		1400-7614	
Attachment to SAMSON Type 3278 with 160 cm ² and to VETEC Type S160, Type R and Type M, heavy-duty version		1400-9245	
Attachment to SAMSON Type 3278 with 320 cm ² and to VETEC Type S320, heavy-duty version		1400-5891 and 1400-9526	
Attachment to Camflex II		1400-9120	
Accessories	Connecting plate	G ¼ ¼ NPT	1400-7461 1400-7462
	Pressure gauge bracket	G ¼ ¼ NPT	1400-7458 1400-7459
		Stainless steel/brass	1402-1637
	Pressure gauge mounting kit up to max. 6 bar	Stainless steel/brass	1402-1637
		Stainless steel/stainless steel	1402-1638

Table 5-11: Attachment of external position sensor

Mounting parts/accessories		Order no.
Template for mounting position sensor on older mounting parts		1060-0784
Direct attachment	Mounting parts for actuator with 120 cm ²	1400-7472
	Connecting plate (9, old) with $G \frac{1}{8}$	1400-6820
	Type 3277-5xxxxx.00 Actuator $\frac{1}{8}$ NPT	1400-6821
	Connecting plate (new) with Type 3277-5xxxxx.01 Actuator (new) ¹⁾	1400-6823
Mounting parts for actuators with 175, 240, 350, 355 and 750 cm ²		1400-7471
NAMUR attachment	Mounting parts for attachment to NAMUR rib using L or XL lever	1400-7468
Attachment to Type 3510 Micro-flow Valve	Mounting parts for Type 3271 Actuator with 60 cm ²	1400-7469
Attachment to rotary actuators	VDI/VDE 3845 (September 2010), see the 'Design and principle of operation' section for details.	
	Actuator surface corresponds to fixing level 1	
	Size AA1 to AA4 with follower clamp and coupling wheel, version with CrNiMo steel bracket	1400-7473
	Size AA1 to AA4, heavy-duty version	1400-9384
	Size AA5, heavy-duty version (e.g. Air Torque 10 000)	1400-9992
	Bracket surface corresponds to fixing level 2, heavy-duty version	1400-9974
SAMSON Type 3278 with 160 cm ² and VETEC Type S160 and Type R, heavy-duty version		1400-9385
SAMSON Type 3278 with 320 cm ² and VETEC Type S320, heavy-duty version		1400-5891 and 1400-9974
Accessories for positioner	Connecting plate (6) $G \frac{1}{4}$	1400-7461
	$\frac{1}{4}$ NPT	1400-7462
	Pressure gauge bracket (7) $G \frac{1}{4}$	1400-7458
	$\frac{1}{4}$ NPT	1400-7459
	Pressure gauge mounting kit up to max. 6 bar	Stainless steel/brass Stainless steel/stainless steel
Bracket to mount the positioner on a wall (Note: The other fastening parts are to be provided at the site of installation as wall foundations vary from site to site).		0309-0184

¹⁾ Only new connecting plates can be used with new actuators (Index 01). Old and new plates are not interchangeable.

6 Operation

⊗ Rotary pushbutton

The rotary pushbutton is located underneath the front protective cover. The positioner is operated on site using the rotary pushbutton:

Turn ⊗: Select codes and values

Press ⊗: confirm setting.

AIR TO OPEN/AIR TO CLOSE slide switch

- AIR TO OPEN applies to a valve opening as the signal pressure increases.
- AIR TO CLOSE applies to a valve closing as the signal pressure increases.

The signal pressure is the pneumatic pressure at the output of the positioner applied to the actuator.

Volume restriction Q

The volume restriction serves to adapt the air output capacity to the size of the actuator. Depending on the air passage at the actuator, two fixed settings are available.

- For actuators smaller than 240 cm² and with a signal pressure connection at the side (Type 3271-5), set restriction to MIN SIDE.
- For a connection at the back (Type 3277-5), set restriction to MIN BACK.
- For actuators 240 cm² and larger, set to MAX SIDE for a side connection and to MAX BACK for a connection at the back.

Readings

Icons assigned to certain codes, parameters and functions are indicated on the display.

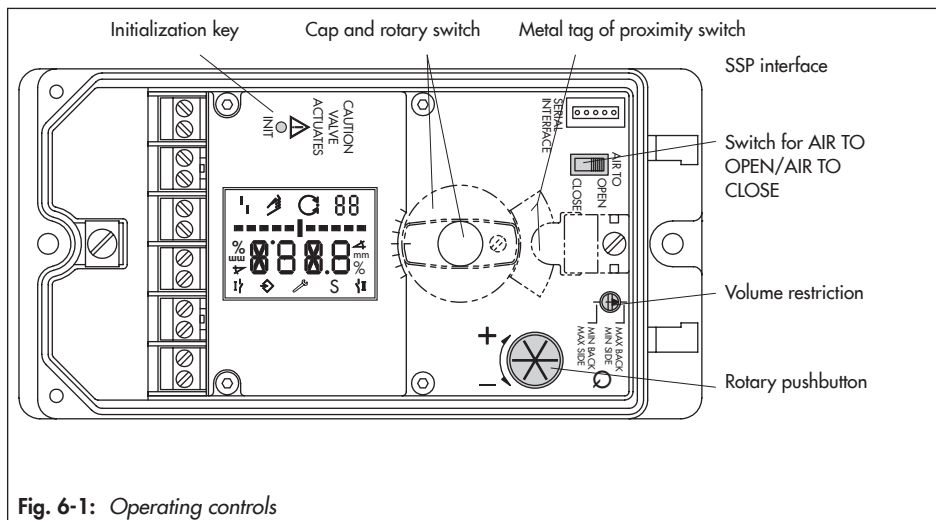







Fig. 6-1: Operating controls

Operation

Operating modes



-  (**manual mode**)
The positioner follows the manual set point (Code 1) instead of the set point of the process control system.
 blinks: The positioner is not initialized. Operation only possible over manual set point (Code 1).
-  (**automatic mode**)
The positioner is in closed-loop operation and follows the set point of the process control system.
- **S SAFE**
The positioner vents the output. The valve moves to the mechanical fail-safe position.

Bar graph

In manual  and automatic  modes, the bars indicate the set point deviation that depends on the sign (+/-) and the value. One bar element appears per 1 % set point deviation.

If the positioner has not been initialized, ( blinks on the display), the bar graph indicates the lever position in degrees in relation to the mid-axis. One bar element corresponds to approximately a 5° angle of rotation. The fifth bar element blinks (reading > 30°) if the permissible angle of rotation has been exceeded. Lever and pin position must be checked.

Status messages

-  Maintenance alarm
-  Maintenance demanded/Maintenance required
-  blinks: Out of specification

These icons indicate that an error has occurred.

A classified status can be assigned to each error. Classifications include "No message", "Maintenance required", "Maintenance demanded" and "Maintenance alarm" (see ► EB 8389-1 on EXPERTplus valve diagnostics).

Enable configuration

This indicates that the codes marked with an asterisk (*) in the code list are enabled for configuration (see the 'Start-up and configuration' section).

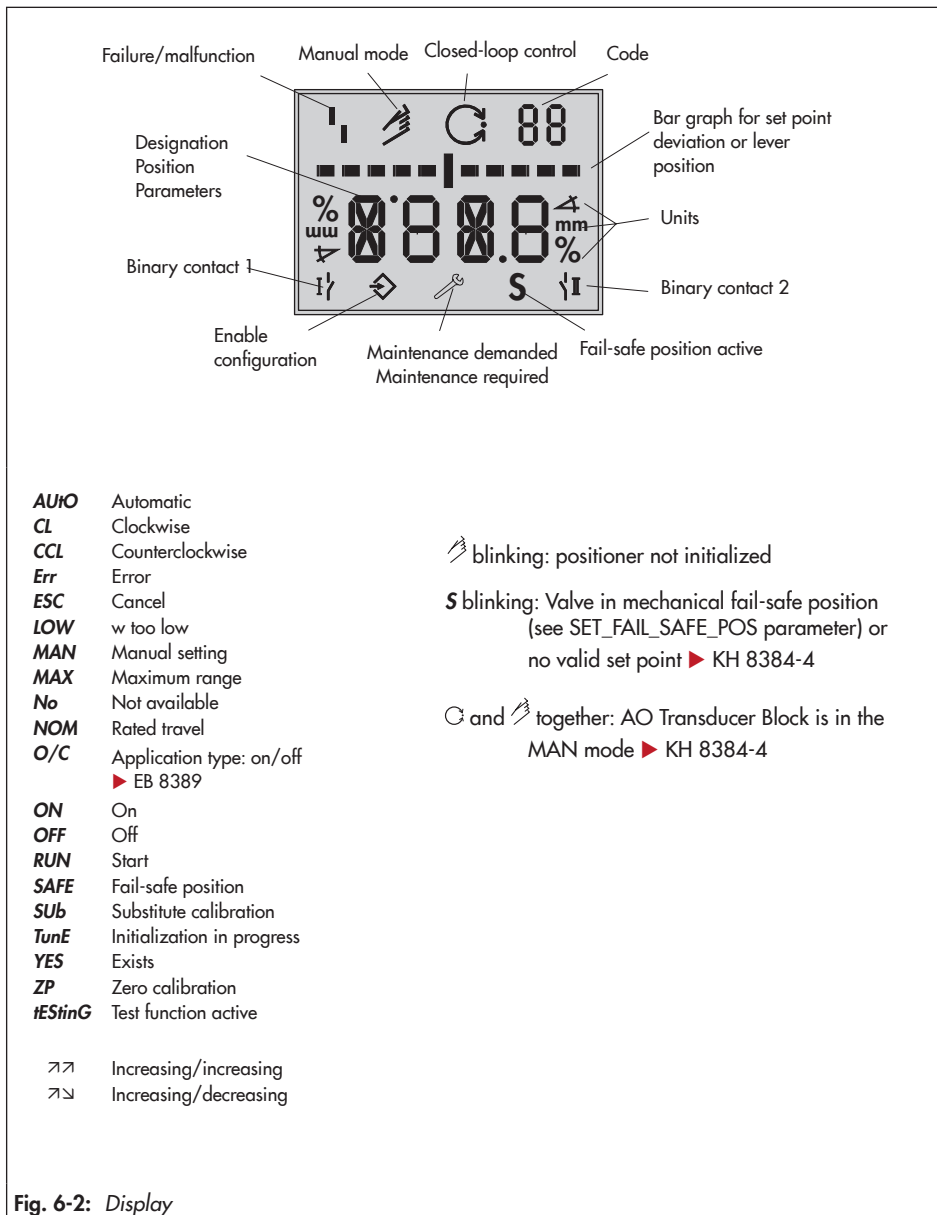

Fig. 6-2: Display

7 Start-up and configuration

The work described in this section is only to be performed by personnel appropriately qualified to carry out such tasks.

⚠ DANGER

Risk of fatal injury due to the ignition of an explosive atmosphere.

- *Observe EN 60079-14 (VDE 0165, Part 1) for work on the positioner in potentially explosive atmospheres.*
 - *Installation, operation or maintenance of the positioner must only be performed by personnel who has undergone special training or instructions or who is authorized to work on explosion-protected devices in hazardous areas.*
-

⚠ WARNING

Crush hazard arising from moving parts on the valve.

- *Do not touch any moving valve parts while the control valve is in operation.*
 - *Before performing any mounting or installation work on the positioner, put the control valve out of operation by disconnecting and locking the supply air and control signal.*
 - *Do not impede the movement of the actuator and plug stem by inserting objects into the yoke.*
-

Before start-up, make sure the following conditions are met:



- The positioner is properly mounted according to the instructions.
 - The pneumatic and electrical connections have been performed according to the instructions.
-

i Note

*The start-up can also be performed without the connected bus network, provided a DC voltage source (9 to 32 V) is connected at the bus connection terminals. **Make sure a sufficiently protected source is used for intrinsically safe positioners.***

Reading after connecting the electrical power supply:



After *tESinG* runs across the display, the  fault alarm icon appears and the  hand icon blinks on the display when the **positioner has not been initialized**. The reading indicates the lever position in degrees in relation to the mid-axis.

Code 0 is displayed when a **positioner has been initialized**. The positioner is in the last active operating mode.

The positioner performs a test in the start-up phase while following its automation task at the same time.

During the start-up phase, operation on site is unrestricted, yet write access is limited.

Sequence for start-up:

Action	Section
1. Determine the fail-safe position.	7.1
2. Adjust the volume restriction Q.	7.2
3. Limit the signal pressure.	7.3
4. Check the operating range of the positioner.	7.4
5. Initialize the positioner.	7.5
6. Configure the positioner by setting further parameters.	7.6
7. Positioners with inductive limit switches: Adjust the inductive limit switch.	7.7

7.1 Determining the fail-safe position

Define the fail-safe position of the valve (0 %) taking the valve type and the actuator's direction of action into account. Position the AIR TO OPEN/AIR TO CLOSE slide switch accordingly:

- **AIR TO OPEN** setting
Signal pressure opens the valve, e.g. for a fail-close valve
The AIR TO OPEN setting always applies to double-acting actuators.
- **AIR TO CLOSE** setting
Signal pressure closes the valve, e.g. for a fail-open valve

For checking purposes: after successfully completing initialization, the positioner display must read 0 % when the valve is closed and 100 % when the valve is open. If this is not the case, change the slide switch position and re-initialize the positioner.

i Note

The switch position is prompted prior to an initialization. After an initialization has been completed, changing the switch position does not have any effect on the operation of the positioner.

7.2 Adjusting the volume restriction Q

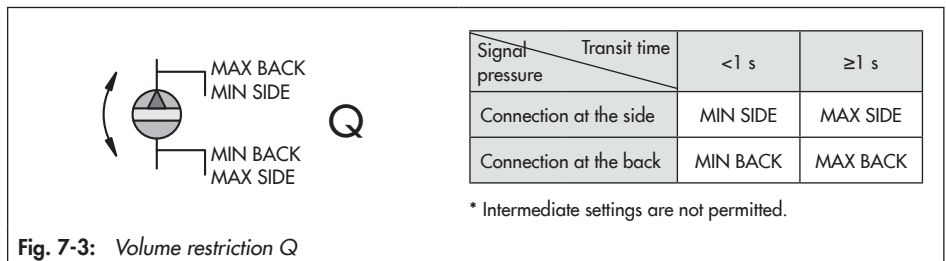

Fig. 7-3: Volume restriction Q

The volume restriction Q serves to adapt the air output capacity to the size of the actuator:

8. Actuators with a **transit time < 1 s**, e.g. linear actuators with an effective area smaller than 240 cm², require a restricted air flow rate (MIN).
9. Actuators with a **transit time ≥ 1 s** do not require the air flow rate to be restricted (MAX).

The position of volume restriction Q also depends on how the signal pressure is routed at the actuator in **SAMSON actuators**:

'SIDE' inscription

- For actuators with a signal pressure connection at the side, e.g. Type 3271-5
- For actuators from other manufacturers

'BACK' inscription

10. For actuators with a signal pressure connection at the back, e.g. Type 3277-5

Start-up and configuration

The following applies to positioners with optional analog input x: the MIN SIDE setting must always be used for actuators with an air volume of less than one liter.

NOTICE

Malfunction due to changed start-up settings.

→ Initialize an initialized positioner again after the position of the volume restriction has been changed.

7.3 Limiting the signal pressure





If the maximum actuator force may cause damage to the valve, the signal pressure must be limited.

→ Do not activate pressure limitation for double-acting actuators (AIR TO OPEN (AIO) fail-safe position). Default setting is 'No'.

Enable configuration at the positioner before limiting the signal pressure.

Enable configuration:



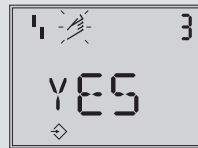

Configuration is locked again if no settings are entered within 120 seconds.

1. Turn  until Code 3 appears (reading: No).
2. Press , the code number 3 blinks.
3. Turn  until YES appears.
4. Press  to confirm (reading: ).



Enable configuration
Default: No

Limit the signal pressure:

1. Turn  until Code 16 appears.
2. Press , the code number 16 blinks.
3. Turn  until the required pressure limit (1.4/2.4/3.7 bar) appears.
4. Press  to confirm.

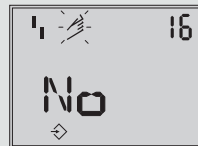





Pressure limit
Default: No

7.4 Checking the operating range of the positioner

To check the mechanical attachment and the proper functioning, the valve should be moved through the operating range of the positioner in the  manual mode with the manual set point.





Select manual mode :

1. Turn  until Code 0 appears.
2. Press , the code number 0 blinks.
3. Turn  until MAN appears.
4. Press . The positioner changes to the manual mode .



Operating mode
Default: MAN

Check the operating range:

1. Turn  until Code 1 appears.
2. Press , the code number 1 and  icon blink.
3. Turn  until the pressure in the positioner builds up and the control valve moves to its final positions so that the travel/angle can be checked.



Manual set point w
(current angle of rota-
tion is indicated)

The angle of rotation of the lever on the back of the positioner is indicated.

A horizontal lever (mid position) is equal to 0°.

To ensure the positioner is working properly, the outer bar elements must not blink while the valve is moving through the operating range.

Exit Code 1 by pressing the rotary pushbutton .

The permissible range has been exceeded when the displayed angle is more than 30° and the outer right or left bar element blinks. The positioner goes to the fail-safe position (SAFE). After canceling the fail-safe position (SAFE) (see the 'Operation' section) it is **absolutely essential** that you check the lever and pin position as described in the 'Installation' section.

⚠ WARNING

Risk of injury due to the actuator stem extending or retracting.

→ Before exchanging the lever or changing the pin position, disconnect the supply air and electrical auxiliary power.

7.5 Initializing the positioner

⚠ WARNING

Risk of injury by exposed moving parts on the positioner, actuator or valve.

→ Do not touch or block exposed moving parts.

ⓘ NOTICE

The process is disturbed by the movement of the actuator or valve.

→ Do not perform the initialization while the process is running. First isolate the plant by closing the shut-off valves.

→ Check the max. permissible signal pressure of the valve before starting initialization. During initialization, the positioner issues an output signal pressure up to the maximum supply pressure supplied. If necessary, limit the signal pressure by connecting an up-stream pressure reducing valve.

i Note

Reset positioner to its default settings (see the 'Operation' section) before mounting it on a different actuator or changing its mounting position.

During initialization, the positioner adapts itself optimally to the friction conditions and the signal pressure required by the control valve. The type and extent of auto tuning depends on the initialization mode selected:

- **Maximum range (MAX)** (standard range)
Initialization mode for simple start-up of valves with two clearly defined mechanical end positions, e.g. three-way valves (see section 7.5.1)
 - **Nominal range (NOM)**
Initialization mode for all globe valves (see section 7.5.2)
-

– **Manually selected OPEN position (MAN)**

Initialization mode for globe valves requiring OPEN position to be entered manually (see section 7.5.3)

– **Substitute calibration (SUB)**

This mode allows a positioner to be replaced while the plant is running, with the least amount of disruption to the plant (see section 7.5.4).

For normal operation, simply start initialization by pressing the INIT key after mounting the positioner on the valve and defining the fail-safe position and setting the volume restriction. The positioner only needs to work with its default settings. If necessary, perform a reset (see the 'Operation' section).

i Note

An initialization procedure in progress can be canceled by pressing the rotary pushbutton. STOP is displayed for three seconds and the positioner changes to the fail-safe position (SAFE). Clear the fail-safe position again over Code 0 (see the 'Operation' section).

The time required for the initialization procedure depends on the actuator transit time, which means that initialization can take a few minutes.

After a successful initialization, the positioner runs in closed-loop operation indicated by the  closed-loop operation icon.

A malfunction leads to the process being canceled. The initialization error is displayed according to how it has been classified by the condensed state (see the 'Malfunction' section).



Alternating readings
Initialization in progress
Icon depending on initialization mode selected



Bar graph display indicating the progress of the initialization

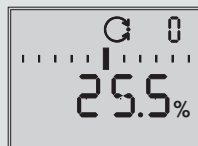

Initialization successfully completed. Positioner in automatic mode ()

i Note

When Code 48 - h0 = YES, the diagnostics automatically start to plot the reference graphs (drive signal steady-state d1 and hysteresis d2) after initialization has been completed. This is indicated by tEst and d1 or d2 appearing on the display in alternating sequence. An error during the plotting of the reference graphs is indicated on the display over Code 48 - h1 and Code 81. The reference graphs do not have any effect on closed-loop operation.

Fail-safe action AIR TO CLOSE

If the slide switch is set to AIR TO CLOSE, the positioner automatically switches to the direction of action increasing/decreasing (↗↘) after initialization has been completed. This results in the assignment (right table) between set point and valve position.

The tight-closing function is activated.

Set Code 15 (set point cutoff increase) to 99 % for three-way valves.





Fail-safe position	Direction of action	Set point Valve	
		CLOSED at	OPEN at
Actuator stem extends (FA) AIR TO OPEN	↗↗	0 %	100 %
Actuator stem retracts (FE) AIR TO CLOSE	↗↘	100 %	0 %

7.5.1 MAX – Initialization based on maximum range

The positioner determines travel/angle of rotation of the closing member from the CLOSED position to the opposite travel stop and adopts this travel/angle of rotation as the operating range from 0 to 100 %.

Enable configuration:



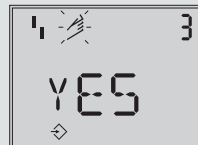

Configuration is locked again if no settings are entered within 120 seconds.

1. Turn  until Code 3 appears (reading: No).
2. Press , the code number 3 blinks.
3. Turn  until YES appears.
4. Press  to confirm (reading: ).



Enable configuration
Default: No

Select the initialization mode:

1. Turn  until Code 6 appears.
2. Press , the code number 6 blinks.
3. Turn  until MAX appears.
4. Press  to confirm the MAX initialization mode.

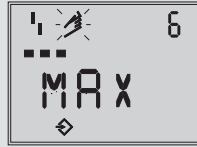

Default: MAX





Start initialization:

- Press INIT key.

The rated travel/angle of rotation is indicated in % after initialization. Code 5 (nominal range) remains locked. The parameters for travel/angle range start (Code 8) and travel/angle range end (Code 9) can also only be displayed and modified in %.

For a reading in mm/°, enter the pin position (Code 4).

Enter the pin position:

1. Turn  until Code 4 appears.
2. Press , the code number 4 blinks.
3. Turn  to select pin position on lever (see relevant section on attachment).
4. Press  to confirm.

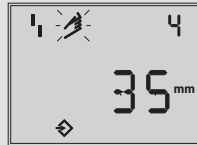
Pin position
Default: No

The nominal range is displayed in mm/°.

7.5.2 NOM – Initialization based on nominal range

The calibrated sensor allows the exact valve travel to be measured very accurately. During initialization, the positioner checks whether the control valve can move through the indicated nominal range (travel or angle) without collision. If this is the case, the indicated nominal range is adopted with the limits of travel/angle range start (Code 8) and travel/angle range end (Code 9) as the operating range.





Start-up and configuration

i Note

The maximum possible travel must always be greater than the rated travel entered. If this is not the case, initialization is automatically canceled (error message Code 52) because the rated travel could not be achieved.

Enable configuration:





Configuration is locked again if no settings are entered within 120 seconds.

1. Turn  until Code 3 appears (reading: No).
2. Press , the code number 3 blinks.
3. Turn  until YES appears.
4. Press  to confirm (reading: ).







Enable configuration
Default: No

Enter the pin position and nominal range:

1. Turn  until Code 4 appears.
2. Press , the code number 4 blinks.
3. Turn  to select pin position on lever (see relevant section on attachment).
4. Press  to confirm.







Pin position
Default: No

5. Turn  until Code 5 appears.
6. Press , the code number 5 blinks.
7. Turn  and set rated travel of the valve.
8. Press  to confirm.



Nominal range
(locked when Code 4 =
No)

Select the initialization mode:

1. Turn  until Code 6 appears.
2. Press , the code number 6 blinks.
3. Turn  until NOM appears.
4. Press  to confirm the NOM initialization mode.

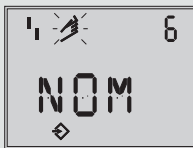

Init mode
Default: MAX

Start initialization:

- Press INIT key.
- After the initialization has been successfully completed:
Check the direction of action (Code 7) and, if necessary, change it.

7.5.3 MAN – Initialization based on a manually selected OPEN position

Before starting initialization, move the control valve manually to the OPEN position. Turn the rotary pushbutton (⊗) clockwise in small steps. The valve must be moved with a monotonically increasing signal pressure. The positioner calculates the differential travel/angle from the OPEN and CLOSED positions and adopts it as the operating range with limits of lower travel/angle range value (Code 8) and upper travel/angle range value (Code 9).

Enable configuration:

Configuration is locked again if no settings are entered within 120 seconds.

1. Turn ⊗ until Code 3 appears (reading: No).
2. Press ⊗, the code number 3 blinks.
3. Turn ⊗ until YES appears.
4. Press ⊗ to confirm (reading: ⇨).



Enable configuration
Default: No

Enter the pin position:





1. Turn ⊗ until Code 4 appears.
2. Press ⊗, the code number 4 blinks.
3. Turn ⊗ to select pin position on lever (see relevant section on attachment).
4. Press ⊗ to confirm.



Pin position
Default: No

Start-up and configuration









Select the initialization mode:

1. Turn  until Code 6 appears.
2. Press , the code number 6 blinks.
3. Turn  until MAN appears.
4. Press  to confirm the MAN initialization mode.



Init mode
Default: MAX

Enter OPEN position:

1. Turn  until Code 0 appears.
2. Press , the code number 0 blinks.
3. Turn  until MAN appears.
4. Press  to confirm.
5. Turn  until Code 1 appears.
6. Press , the code number 1 blinks.
7. Turn  until the required valve position is reached.
8. Press  to confirm the OPEN position.



Manual set point
(current angle of rotation is indicated)

Start initialization:

- Press INIT key.

7.5.4 Sub – Substitute calibration

A complete initialization procedure takes several minutes and requires the valve to move through its entire travel range several times. In the SUB initialization mode, the control parameters are estimated and not determined by an initialization procedure. As a result, a high level of accuracy cannot be expected. A different initialization mode should be selected if the plant allows it.

The substitute calibration is used to replace a positioner while the process is running. For this purpose, the control valve is usually fixed mechanically in a certain position or pneumatically





by means of a pressure signal which is routed to the actuator externally. The blocking position ensures that the plant continues to operate with this valve position.

By entering the blocking position (Code 35), closing direction (Code 34), pin position (Code 4), nominal range (Code 5) and direction of action (Code 7), the positioner can calculate the positioner configuration.

→ Perform a reset before re-initializing the positioner if the substitute positioner has already been initialized (see the 'Operation' section).

Enable configuration:









Configuration is locked again if no settings are entered within 120 seconds.

1. Turn  until Code 3 appears (reading: No).
2. Press , the code number 3 blinks.
3. Turn  until YES appears.
4. Press  to confirm (reading: ).



Enable configuration
Default: No

Enter the pin position and nominal range:

1. Turn  until Code 4 appears.
2. Press , the code number 4 blinks.
3. Turn  to select pin position on lever (see relevant section on attachment).
4. Press  to confirm.
5. Turn  until Code 5 appears.
6. Press , the code number 5 blinks.
7. Turn  and set rated travel of the valve.
8. Press  to confirm.

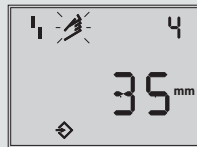





Pin position
Default: No



Nominal range
(locked when Code 4 = No)

Start-up and configuration



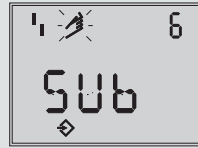

Select the initialization mode:

1. Turn  until Code 6 appears.
2. Press , the code number 6 blinks.
3. Turn  until SUB appears.
4. Press  to confirm the SUB initialization mode.



Init mode
Default: MAX



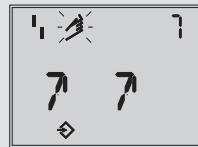

Enter the direction of action:

1. Turn  until Code 7 appears.
2. Press , the code number 7 blinks.
3. Turn  to select the direction of action (↗/↘).
4. Press  to confirm.



Direction of action
Default: ↗

Deactivate travel limit:

1. Turn  until Code 11 appears.
2. Press , the code number 11 blinks.
3. Turn  until No appears.
4. Press  to deactivate the travel limit function.

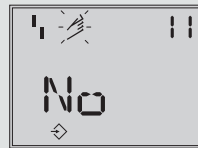







Travel limitation
Default: No

Change pressure limit and control parameters:





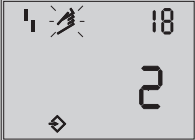

Note

Do not change the pressure limit (Code 16). Only change the control parameters K_p (Code 17) and T_v (Code 18) if the settings of the replaced positioner are known.

1. Turn  until the required Code 16/17/18 appears.
2. Press , the code number 16/17/18 blinks.
3. Turn  to set the control parameter selected.
4. Press  to confirm.

		Pressure limit Default: No
		K _p level Default: 7
		T _v level Default: 2

Enter closing direction and blocking position:

1. Turn  until Code 34 appears.
2. Press , the code number 34 blinks.
3. Turn  and set the closing direction (CCL = counterclockwise/CL = clockwise).
4. Press  to confirm.
5. Turn  until Code 35 appears.
6. Press , the code number 35 blinks.
7. Turn  to set the blocking position, e.g. 5 mm (read off at travel indicator scale of the blocked valve or measure with a ruler).
8. Set switch for fail-safe position AIR TO OPEN or AIR TO CLOSE according to section 7.1.
9. Adjust volume restriction as described in section 7.2.

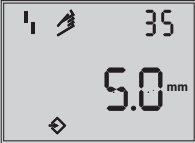
		Closing direction (direction of rotation causing the valve to move to the CLOSED position (view onto positioner display); standard CCL
		Blocking position Default: 0

Start-up and configuration









Start initialization:

- Press INIT key.
The positioner switches to MAN mode.
The blocking position is indicated.

Since initialization has not been completed, the error code 76 (no emergency mode) and possibly also error code 57 (control loop) may appear on the display. These alarms do not influence the positioner's readiness for operation.

Cancel the blocking position and change to automatic mode (AUTO):

For the positioner to follow its set point again, the blocking position must be canceled and the positioner must be set to automatic mode as follows:

1. Turn  until Code 1 appears.
2. Press , the code number 1 and  icon blink.
3. Turn  to build up pressure in the positioner to move the valve slightly past the blocking position.
4. Press  to cancel the mechanical blocking.
5. Turn  until Code 0 appears.
6. Press , the code number 0 blinks.
7. Turn  until *AUTO* appears.
8. Press  to confirm. The positioner switches to automatic mode. The current valve position is indicated in %.

- If the positioner shows a tendency to oscillate in automatic mode, the parameters K_p and T_v must be slightly corrected. Proceed as follows:
 - Set T_v (Code 18) to 4.
 - If the positioner still oscillates, the gain K_p (Code 17) must be decreased until the positioner shows a stable behavior.

Zero point calibration

→ Finally, if process operations allow it, the zero point must be calibrated according to the 'Operation' section.

7.6 Setting other parameters

All codes and their meaning and default settings are listed in the code list in Annex A.

Codes which are marked with an asterisk must be enabled with Code 3 before the associated parameters can be configured as described below.

Turn until Code 3 appears (reading: No).
 Press , the code number 3 blinks.
 Change the setting in Code 3.
 Turn until YES appears.
 Press , reading:
 Configuration is enabled.
 You can now configure codes one after the other:
 Turn to select the required code.
 Press to activate the selected code. The code number starts to blink.
 Turn to select the setting.
 Press to confirm the selected setting.

Code 3
Configuration not enabled

Configuration enabled

If no settings are entered within 120 seconds, the enabled configuration function becomes invalid and the display returns to Code 0.

Cancel the setting:

To cancel a value before it is confirmed (by pressing) proceed as follows:

Turn until ESC appears.
 Press to confirm.
 The entered value is not adopted.

Canceling the reading

7.7 Start-up via local interface (SSP)

The positioner can either be start up, configured and operated on site, using the fieldbus configuration or operating system or TROVIS-VIEW user interface connected over the serial interface in the positioner. Use the TROVIS-VIEW software with 3730-4 device module installed.

To connect the positioner directly to the computer via the local serial interface, an adapter (order no. 1400-9740) is required.





The power supply for the positioner can be supplied either over the connection to the fieldbus segment or over a DC voltage source (9 to 32 V) connected to the bus terminals in the positioner (a suitable intrinsically safe source must be used inside and outside the hazardous area for intrinsically safe positioners). The simultaneous operation of TROVIS-VIEW and the fieldbus system is possible without any restrictions when connected to a PROFIBUS-PA segment.

7.8 Setting the bus address

A maximum of 32 positioners in a safe (non-hazardous) area can be operated in parallel over a segment coupler in one PROFIBUS-PA segment. Each positioner connected in the segment must be assigned a unique bus address between 0 and 125.

Enable configuration:





Configuration is locked again if no settings are entered within 120 seconds.

1. Turn  until Code 3 appears (reading: No).
2. Press , the code number 3 blinks.
3. Turn  until YES appears.
4. Press  to confirm (reading: ).



Enable configuration
Default: No

Setting the bus address:

1. Turn  until Code 46 appears.
2. Press , the code number 46 blinks.
3. Turn  and select the desired bus address.
4. Press  and hold for 10 seconds.



Default: 126

The address is adopted straightaway, provided that cyclic data exchange is not taking place. During the cyclic data exchange, the newly set address for the positioner is saved and adopted after the cyclic data exchange is completed. The newly assigned address is indicated in Code 46 in alternating sequence with the current address. The new address is marked with 'n' (new) and the currently used address with 'o' (old).

i Note

The bus address can only be implemented by the PROFIBUS command SET_ADDRESS when the bus address is set to the default setting [126]. Refer to Configuration Manual

► KH 8384-4.

7.9 Adjusting inductive limit switch

The positioner version with an inductive limit switch has an adjustable tag (1) mounted on the axis of rotation, which operates the proximity switch (3).

For operation of the inductive limit switch, the corresponding switching amplifier (see the 'Installation' section) must be connected to the output circuit.

When the tag (1) is located in the inductive field of the switch, the switch assumes a high resistance. When it moves outside the field, the switch assumes a low resistance.

Normally, the limit switch is adjusted in such a way that it will provide a signal in both end positions of the valve. The switch, however, can also be adjusted to indicate intermediate valve positions.

The required switching function, i.e. whether the output relay is to be picked up or released when the tag enters the field, must be selected at the switching amplifier, if required.

Adjusting the switching point

i Note

During adjustment or testing, the switching point must always be approached from mid-position (50 %).

To guarantee the switching under all ambient conditions, adjust the switching point approx. 5 % before the mechanical stop (OPEN – CLOSED).

For CLOSED position:

1. Initialize the positioner.
2. Move the valve to 5 % in the MAN mode (see display).
3. Adjust the tag at the yellow adjustment screw (2) until the tag enters or leaves the field and the switching amplifier responds.
You can measure the switching voltage as an indicator.

Contact function:

- Tag leaving the field > contact is closed.
- Tag entering the field > contact is opened.

For OPEN position:

1. Initialize the positioner.
2. Move the valve to 95 % in the MAN mode (see display).
3. Adjust the tag (1) at the yellow adjustment screw (2) until the tag enters or leaves the field of the proximity switch (3).
You can measure the switching voltage as an indicator.

Contact function:

- Tag leaving the field > contact is closed.
- Tag entering the field > contact is opened.

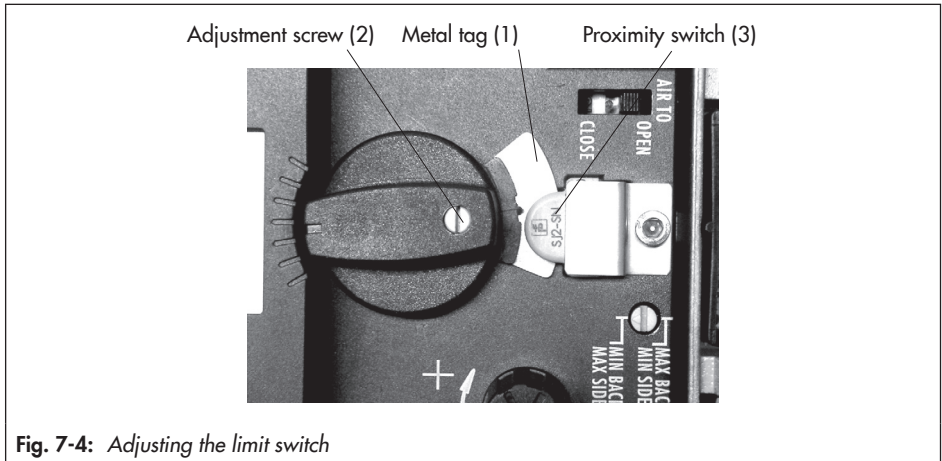

Fig. 7-4: Adjusting the limit switch

8 Operation

The work described in this section is only to be performed by personnel appropriately qualified to carry out such tasks.

⚠ DANGER

Risk of fatal injury due to the ignition of an explosive atmosphere.

- Installation, operation or maintenance of the positioner must only be performed by personnel who has undergone special training or instructions or who is authorized to work on explosion-protected devices in hazardous areas.





⚠ WARNING

Crush hazard arising from moving parts on the valve.

- Do not touch any moving valve parts while the control valve is in operation.
- Before performing any mounting or installation work on the positioner, put the control valve out of operation by disconnecting and locking the supply air and control signal.
- Do not impede the movement of the actuator and plug stem by inserting objects into the yoke.

8.1 Adapting the display direction

The display contents can be turned by 180° to adapt the display reading to the actuator's mounting situation. If the displayed data appear upside down, proceed as follows:

1. Turn  until Code 2 appears.
2. Press  , the code number 2 blinks.
3. Turn  and select the desired reading direction.
4. Press  to confirm.

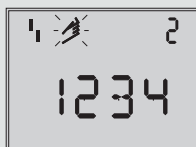

Reading direction for right attachment of pneumatic connections

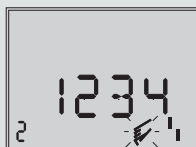

Reading direction for left attachment of pneumatic connections

8.2 Changing the operating mode

8.2.1 Closed-loop operation (automatic mode)





After initialization has been completed successfully, the positioner is in  automatic mode (AUTO).



Automatic mode

8.2.2 Manual mode

Switching to  manual mode (MAN):

1. Turn  until Code 0 appears.
2. Press , reading: *AUTO*, the code number 0 blinks.
3. Turn  until *MAN* appears.
4. Press . The positioner changes to the manual mode ().

The manual mode starts using the last set point used in automatic mode, ensuring a bumpless changeover. The current position is displayed in %.

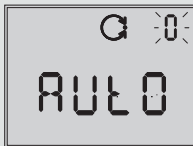

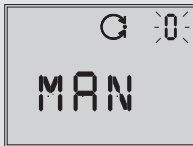

Automatic mode



Manual mode





Adjusting the manual set point:

1. Turn  until Code 1 appears.
2. Press , the code number 1 blinks.
3. Turn  until sufficient pressure has been built up in the positioner and the control valve moves to the required position.







The positioner automatically returns to Code 0 if no settings are made within 120 seconds, but remains in the manual mode.

Switch to automatic mode (AUTO)

1. Turn  until Code 0 appears.
2. Press , the code number 0 blinks.
3. Turn  until *AUTO* appears.
4. Press . The positioner switches to automatic mode.

8.2.3 Fail-safe position (SAFE)





If you want to move the valve to the fail-safe position determined during start-up (see the 'Start-up and configuration' section), proceed as follows:

1. Turn  until Code 0 appears.
2. Press , reading: current operating mode (AUTO or MAN), the code number 0 blinks.
3. Turn  until *SAFE* appears.
4. Press , reading: *S*



The valve moves to the fail-safe position.
If the positioner has been initialized, the current valve position in % is indicated on the display.

Exiting the fail-safe position:

1. Turn  until Code 0 appears.
2. Press , the code number 0 blinks.
3. Turn  and select the required operating mode (AUTO or MAN).
4. Press  to confirm.
5. The positioner switches to the operating mode selected.

8.3 Performing zero calibration

In case of inconsistencies in the closed position of the valve, e.g. with soft-seated plugs, it might be necessary to recalibrate zero.

⚠ WARNING

Risk of injury due to the actuator stem extending or retracting.

→ Do not touch or block the actuator stem.

! NOTICE





The process is disturbed by the movement of the actuator stem.

→ Do not perform zero calibration while the process is running. First isolate the plant by closing the shut-off valves.

The positioner must be connected to the supply air to perform the zero calibration.

Enable configuration:

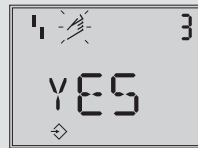

Configuration is locked again if no settings are entered within 120 seconds.

1. Turn  until Code 3 appears (reading: No).
2. Press , the code number 3 blinks.
3. Turn  until YES appears.
4. Press  to confirm (reading: ).



Enable configuration
Default: No

Perform zero calibration:

1. Turn  until Code 6 appears.
 2. Press , the code number 6 blinks.
 3. Turn  until ZP appears.
- Press INIT key.
Zero calibration starts. The positioner moves the valve to the CLOSED position and recalibrates the internal electrical zero point.

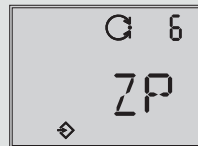





Init mode
Default: MAX

8.4 Resetting the positioner

This function resets all start-up and setting parameters as well as the diagnosis to the factory default settings (see code list in Annex).

Enable configuration:



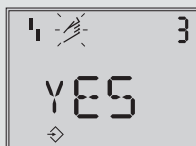

Configuration is locked again if no settings are entered within 120 seconds.

1. Turn  until Code 3 appears (reading: No).
2. Press , the code number 3 blinks.
3. Turn  until YES appears.
4. Press  to confirm (reading: ).



Enable configuration
Default: No

Reset start-up parameters:

1. Turn  until Code 36 appears (reading: ).
2. Press , the code number 36 blinks.
3. Turn  until *DIAG/STD/DS* appears.
4. Press  to confirm.
All start-up parameters as well as the diagnosis are reset to their default values.

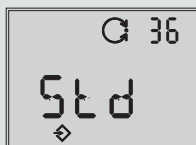



Reset
Default: No

Note

- Code 36 - diAG allows just the diagnosis data (*EXPERTplus*) to be reset. Refer to the *Operating Instructions for EXPERTplus valve diagnostics* ► EB 8389.
- The *FACTORY_RESET* parameter resets the control and identification parameters as well as the bus address. Refer to *Configuration Manual* ► KH 8384-4.

9 Malfunctions

Malfunctions are indicated on the display by error codes. Annex A lists possible error messages and recommended action.

The error codes appear on the display corresponding to their status classification set over the condensed state (Maintenance required/Maintenance demanded: , Maintenance alarm: ). If 'No message' is assigned to the error code as the status classification, the error is not included in the condensed state.

A status classification is assigned to every error code in the default setting. The assignment of the status classification can be changed in TROVIS-VIEW and over the PROFIBUS-PA parameters. Refer to the Operating Instructions for the EXPERTplus valve diagnostics ► EB 8389 and the Configuration Manual ► KH 8384-4 for more details.

To provide a better overview, the classified messages are summarized in a condensed state for the positioner according to the NAMUR Recommendation NE 107. The status messages are divided into the following categories:



- **Maintenance alarm**
The positioner cannot perform its control task due to a malfunction in the positioner itself or in one of its peripherals or the positioner has not yet been successfully initialized.
- **Maintenance required**
The positioner still performs its control task (with restrictions). A maintenance demand or above average wear has been determined. The wear tolerance will

soon be exhausted or is reducing at a faster rate than expected. Maintenance is necessary in the medium term.

- **Maintenance demanded**
The positioner still performs its control task (with restrictions). A maintenance demand or above average wear has been determined. The wear tolerance will soon be exhausted or is reducing at a faster rate than expected. Maintenance is necessary in the short term.
- **Process-related malfunction/out of specification**
The device is running outside the specified operating conditions..
- **Function check**
Test or calibration procedures are performed in the positioner. The positioner is temporarily unable to perform its control task as long as the procedure is taking place.

If an event is classified as “No message”, this event does not have any affect on the condensed state.

Table 9-1: Condensed state reading

Condensed state	Positioner display
Maintenance alarm	
Function check	Text e.g. <i>TUNE</i> or <i>TEST</i>
Maintenance required/maintenance demanded	
Process-related malfunction/out of specification	 blinking
No message	–

Malfunctions

The message with the highest priority determines the condensed state in the positioner.

9.1 Troubleshooting

⚠ DANGER

Risk of fatal injury due to the ignition of an explosive atmosphere.

→ *Installation, operation or maintenance of the positioner must only be performed by personnel who has undergone special training or instructions or who is authorized to work on explosion-protected devices in hazardous areas.*

⚠ WARNING

Crush hazard arising from moving parts on the valve.

- *Do not touch any moving valve parts while the control valve is in operation.*
- *Before performing any mounting or installation work on the positioner, put the control valve out of operation by disconnecting and locking the supply air and control signal.*
- *Do not impede the movement of the actuator and plug stem by inserting objects into the yoke.*

Table 9-1 lists general errors.

If fault alarms exist, the possible source of error is displayed in Code 49 onwards. In this case, Err is displayed.

Example:

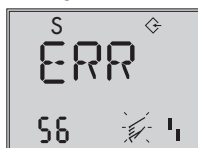

Example:
Error caused by pin position

→ Refer to the code list (Annex A) for possible causes and the recommended action.

Confirming error messages

1. Turn **⊗** until Code 3 appears (reading: No).
2. Press **⊗**, the code number 3 blinks.
3. Turn **⊗** until YES appears.
4. Press **⊗** to confirm (reading: **⇒**).
5. Turn **⊗** until the the error code that you want appears.
6. Press **⊗** to confirm the error message.

i Note

Contact SAMSON's After-sales Service for malfunctions that cannot be remedied as described in Table 9-2 and the code list in Annex A.

9.2 Emergency action

Fail-safe action is triggered by the i/p converter or solenoid valve and upon supply air failure. The positioner fully discharges its pneumatic output to the atmosphere, causing the pneumatic actuator to be vented. As a result, the valve moves to the fail-safe position. The fail-safe position depends on how the springs are arranged in the pneumatic actuator (air-to-close or air-to-open).

When the supply air fails, the optional solenoid valve or forced venting is triggered and after reaching the shutdown signal, all positioner functions, except open/closed loop control, remain active (including diagnostics as well as position and status feedback).



Tip

Emergency action in the event of valve or actuator failure is described in the associated valve and actuator documentation.

→ Plant operators are responsible for emergency action to be taken in the plant.

Table 9-2: Further troubleshooting

Error description	Measures
No reading on the display	<ul style="list-style-type: none"> → Check electrical connection and electrical power. → Check the ambient temperature (the display's operating range is from -30 to $+65$ °C).
Actuator moves too slowly	<ul style="list-style-type: none"> → Check the supply pressure. → Deactivate software restriction. → Check the cross-section of the piping and screw fittings. → Check the configuration of the mounting parts.
Actuator moves in the wrong direction.	<ul style="list-style-type: none"> → Check the characteristic setting. → Check the piping. → Check the configuration of the mounting parts.
Air leaks from the positioner.	<ul style="list-style-type: none"> → Check attachment. → Check the seals in the connecting plate.

10 Servicing

The work described in this section is only to be performed by personnel appropriately qualified to carry out such tasks.

⚠ DANGER

Risk of fatal injury due to the ignition of an explosive atmosphere.

- Installation, operation or maintenance of the positioner must only be performed by personnel who has undergone special training or instructions or who is authorized to work on explosion-protected devices in hazardous areas.

⚠ WARNING

Crush hazard arising from actuator and plug stem moving.

- Do not touch any moving valve parts while the control valve is in operation.
- Before performing any mounting or installation work on the positioner, put the control valve out of operation by disconnecting and locking the supply air and control signal.
- Do not impede the movement of the actuator and plug stem by inserting objects into the yoke.

⚠ WARNING

Intrinsic safety rendered ineffective in intrinsically safe devices.

- Only connect intrinsically safe devices intended for use in intrinsically safe circuits to certified intrinsically safe input-connected units.
- Do not place intrinsically safe devices back into operation that were connected to intrinsically safe input-connected units without certification.
- Do not exceed the maximum permissible electric values specified in the EC type examination certificates when interconnecting intrinsically safe electrical equipment (U_i or U_o , I_i or I_o , P_i or P_o , C_i or C_o and L_i or L_o).

The positioner was checked by SAMSON before it left the factory.

- The product warranty becomes void if service or repair work not described in these instructions is performed without prior agreement by SAMSON's After-sales Service.
- Only use original spare parts by SAMSON, which comply with the original specifications.

The positioner does not require any maintenance.

10.1 Cleaning the cover window

Occasionally, the window in the cover may need to be cleaned.

! NOTICE

Incorrect cleaning will damage the window. The window is made of Makrolon® (new design) and will be damaged when cleaned with abrasive cleaning agents or agents containing solvents.

- Do not rub the window dry.
- Do not use any cleaning agents containing chlorine or alcohol or abrasive cleaning agents.
- Use a non-abrasive, soft cloth for cleaning.

10.2 Cleaning the filters

There are filters with a 100 µm mesh size in the pneumatic connections for supply and output which can be removed and cleaned, if required.

10.3 Maintenance of the supply air pressure reducing stations

The maintenance instructions of any upstream supply air pressure reducing stations must be observed.

10.4 Firmware updates

Firmware updates on positioners currently in operation can be performed as described below. Only individuals with a written approval may perform updates. Approved individuals are named by SAMSON's Quality Assurance and assigned a test mark.

Laptops and computers connected to the power supply must only be interconnected with intrinsically safe equipment if the SAMSON isolated USB interface adapter (order no. 1400-9740) is connected in-between for software programming or test routines.

Updates outside the hazardous area:

- Remove the positioner and perform the update outside the hazardous area.



Updates on site:

- Updates on site are only permitted after the plant operator presented a signed hot work permit.
- After updating has been completed, add the current firmware to the nameplate (e.g. using a label).
- The individual approved by SAMSON confirms the update by attaching the assigned test mark (stamp).

10.5 Periodic inspection and testing of the positioner

We recommend inspection and testing according to Table 10-1 at the minimum.

Table 10-1: *Recommended inspection and testing*

Inspection and testing	Action to be taken in the event of a negative result
Check the markings, labels and nameplates on the positioner for their readability and completeness.	Immediately renew damaged, missing or incorrect nameplates or labels.
	Clean any inscriptions that are covered with dirt and are illegible.
Check the positioner and leakage sensor (if installed) to ensure they are mounted firmly.	Tighten the any loose mounting screws.
Check the pneumatic connections.	Tighten any loose male connectors of the screw fittings.
	Renew any air pipes or hoses that leak.
Check the power supply wires.	Tighten any loose cable glands.
	Make sure that the stranded wires are pushed into the terminals and tighten any loose screws on the the terminals.
	Renew damaged lines.
Check error messages on the display (indicated by the  and  icons).	Troubleshooting (see the 'Malfunctions' section).

11 Decommissioning

The work described in this section is only to be performed by personnel appropriately qualified to carry out such tasks.

DANGER

Risk of fatal injury due to ineffective explosion protection.

The explosion protection becomes ineffective when the positioner cover is opened.

→ *The following regulations apply to installation in hazardous areas: EN 60079-14 (VDE 0165, Part 1).*

NOTICE

The process is disturbed by interrupting closed-loop control.

→ *Do not mount or service the positioner while the process is running and only after isolating the plant by closing the shut-off valves.*

To decommission the positioner before removing it, proceed as follows:

- Put the control valve out of operation. See associated valve documentation.
- Shut off and lock the supply air line to the positioner.
- Disconnect and lock the electrical power supply.

12 Removal

The work described in this section is only to be performed by personnel appropriately qualified to carry out such tasks.

DANGER

Risk of fatal injury due to the ignition of an explosive atmosphere.

- *The following regulations apply to installation in hazardous areas: EN 60079-14 (VDE 0165, Part 1).*
 - *Installation, operation or maintenance of the positioner must only be performed by personnel who has undergone special training or instructions or who is authorized to work on explosion-protected devices in hazardous areas.*
-
- Put the positioner out of operation (see the 'Decommissioning' section).
 - Disconnect the wires for electrical input and remove them from the positioner.
 - Unscrew the screw fittings at the Output 38 and Supply 9 ports of the positioner.
 - To remove the positioner, loosen the three fastening screws on the positioner.

13 Repairs

A defective positioner must be repaired or replaced.

! NOTICE

Risk of positioner damage due to incorrect service or repair work.

- Do not perform any repair work on your own.
- Contact SAMSON's After-sales Service for service and repair work.

13.1 Servicing explosion-protected devices

If a part of the device on which the explosion protection is based needs to be serviced, the device must not be put back into operation until a qualified inspector has assessed it according to explosion protection requirements, has issued an inspection certificate, or given the device a mark of conformity. Inspection by a qualified inspector is not required if the manufacturer performed a routine test on the device before putting it back into operation. Document the passing of the routine test by attaching a mark of conformity to the device.

Replace explosion-protected components only with original, routine-tested components by the manufacturer.

Devices that have already been used outside hazardous areas and are intended for future use inside hazardous areas must comply with the safety requirements placed on serviced devices. Before being operated inside

hazardous areas, test the devices according to the specifications for servicing explosion-protected devices.

EN 60079-19 applies to servicing explosion-protected devices.

13.2 Returning devices to SAMSON

Defective devices can be returned to SAMSON for repair.

Proceed as follows to return devices to SAMSON:

1. Put the positioner out of operation (see the 'Decommissioning' section).
2. Remove the positioner (see the 'Removal' section).
3. Proceed as described on the Returning goods page of our website
 ► www.samsongroup.com > Service & Support > After-sales Service > Returning goods

14 Disposal



We are registered with the German national register for waste electric equipment (stiftung ear) as a producer of electrical and electronic equipment, WEEE reg. no.: DE 62194439

- Observe local, national and international refuse regulations.
- Do not dispose of components, lubricants and hazardous substances together with your other household waste.



On request, we can appoint a service provider to dismantle and recycle the product.

15 Certificates

The following certificate is shown on the next page:

- EU declaration of conformity for Type 3730-4
- EU declaration of conformity for Type 3730-41
- EU declaration of conformity for Type 3730-45
- EU declaration of conformity for Type 3730-48
- EAC certificate for Type 3730-4
- ATEX: EC type examination certificate for Type 3730-41 and Type 3730-45
- ATEX: Statement of conformity for Type 3730-48
- IECEx: IECEx Certificate of Conformity for Type 3730-41, Type 3730-45 and Type 3730-48
- CSA certificate
- FM certificate
- EAC (GOST): Certificate for Type 3730-4

The certificates shown were up to date at the time of publishing. The latest certificates can be found on our website:

► www.samsongroup.com > Products & Applications > Product selector > Valve accessories > 3730-4



EU Konformitätserklärung / EU Declaration of Conformity / Déclaration UE de conformité

Die alleinige Verantwortung für die Ausstellung dieser Konformitätserklärung trägt der Hersteller/
This declaration of conformity is issued under the sole responsibility of the manufacturer/
La présente déclaration de conformité est établie sous la seule responsabilité du fabricant.
Für das folgende Produkt / For the following product / Nous certifions que le produit

Elektropneumatischer Stellungsregler mit PROFIBUS-PA-Kommunikation / Electropneumatic Positioner with PROFIBUS-PA communication / Positionneur électropneumatique avec communication PROFIBUS-PA Typ/Type/Type 3730-4...

wird die Konformität mit den einschlägigen Harmonisierungsrechtsvorschriften der Union bestätigt/
the conformity with the relevant Union harmonisation legislation is declared with/
est conforme à la législation d'harmonisation de l'Union applicable selon les normes:

EMC 2014/30/EU

EN 61000-6-2:2005, EN 61000-6-3:2007
+A1:2011, EN 61326-1:2013

RoHS 2011/65/EU

EN 50581:2012

Hersteller / Manufacturer / Fabricant:

SAMSON AKTIENGESELLSCHAFT
Weismüllerstraße 3
D-60314 Frankfurt am Main
Deutschland/Germany/Allemagne

Frankfurt / Francfort, 2017-07-29

Im Namen des Herstellers/ On behalf of the Manufacturer/ Au nom du fabricant.

i.v. H. Zager

Hanno Zager
Leiter Qualitätssicherung/Head of Quality Management/
Responsable de l'assurance de la qualité

i.v. Dirk Hoffmann

Dirk Hoffmann
Zentralabteilungsleiter/Head of Department/Chef du département
Entwicklungsorganisation/Development Organization



EU Konformitätserklärung / EU Declaration of Conformity / Déclaration UE de conformité

Die alleinige Verantwortung für die Ausstellung dieser Konformitätserklärung trägt der Hersteller/
This declaration of conformity is issued under the sole responsibility of the manufacturer/
La présente déclaration de conformité est établie sous la seule responsabilité du fabricant.
Für das folgende Produkt / For the following product / Nous certifions que le produit

Elektropneumatischer Stellungsregler mit PROFIBUS-PA-Kommunikation / Electropneumatic Positioner with PROFIBUS-PA communication / Positionneur électropneumatique avec communication PROFIBUS-PA Typ/Type/Type 3730-41..

entsprechend der EU-Baumusterprüfbescheinigung PTB 04 ATEX 2109 ausgestellt von der/
according to the EU Type Examination PTB 04 ATEX 2109 issued by/
établi selon le certificat CE d'essais sur échantillons PTB 04 ATEX 2109 émis par:

Physikalisch Technische Bundesanstalt
Bundesallee 100
D-38116 Braunschweig

Benannte Stelle/Notified Body/Organisme notifié 0102

wird die Konformität mit den einschlägigen Harmonisierungsrechtsvorschriften der Union bestätigt/
the conformity with the relevant Union harmonisation legislation is declared with/
est conforme à la législation d'harmonisation de l'Union applicable selon les normes:

EMC 2014/30/EU	EN 61000-6-2:2005, EN 61000-6-3:2007 +A1:2011, EN 61326-1:2013
Explosion Protection 94/9/EC (bis/to 2016-04-19)	EN 60079-0:2012/A11:2013,
Explosion Protection 2014/34/EU (ab/from 2016-04-20)	EN 60079-11:2012, EN 60079-31:2014
RoHS 2011/65/EU	EN 50581:2012

Hersteller / Manufacturer / Fabricant:

SAMSON AKTIENGESELLSCHAFT
Weismüllerstraße 3
D-60314 Frankfurt am Main
Deutschland/Germany/Allemagne

Frankfurt / Francfort, 2017-07-29

Im Namen des Herstellers/ On behalf of the Manufacturer/ Au nom du fabricant.

Hanno Zager
Leiter Qualitätssicherung/Head of Quality Management/
Responsable de l'assurance de la qualité

Dirk Hoffmann
Zentralabteilungsleiter/Head of Department/Chef de département
Entwicklungsorganisation/Development Organization

oe_2729-41_de_en_fr_07.pdf

SAMSON

EU Konformitätserklärung / EU Declaration of Conformity / Déclaration UE de conformité

Die alleinige Verantwortung für die Ausstellung dieser Konformitätserklärung trägt der Hersteller/
This declaration of conformity is issued under the sole responsibility of the manufacturer/
La présente déclaration de conformité est établie sous la seule responsabilité du fabricant.
Für das folgende Produkt / For the following product / Nous certifions que le produit

Elektropneumatischer Stellungsregler mit PROFIBUS-PA-Kommunikation / Electropneumatic Positioner with PROFIBUS-PA communication / Positionneur électropneumatique avec communication PROFIBUS-PA Typ/Type/Type 3730-45..

entsprechend der EU-Baumusterprüfbescheinigung PTB 04 ATEX 2109 ausgestellt von der/
according to the EU Type Examination PTB 04 ATEX 2109 issued by/
établi selon le certificat CE d'essais sur échantillons PTB 04 ATEX 2109 émis par:

Physikalisch Technische Bundesanstalt
Bundesallee 100
D-38116 Braunschweig

Benannte Stelle/Notified Body/Organisme notifié 0102

wird die Konformität mit den einschlägigen Harmonisierungsrechtsvorschriften der Union bestätigt/
the conformity with the relevant Union harmonisation legislation is declared with/
est conforme à la législation d'harmonisation de l'Union applicable selon les normes:

EMC 2014/30/EU	EN 61000-6-2:2005, EN 61000-6-3:2007 +A1:2011, EN 61326-1:2013
Explosion Protection 94/9/EC (bis/to 2016-04-19) Explosion Protection 2014/34/EU (ab/from 2016-04-20)	EN 60079-0:2012/A11:2013, EN 60079-11:2012, EN 60079-31:2014
RoHS 2011/65/EU	EN 50581:2012

Hersteller / Manufacturer / Fabricant:

SAMSON AKTIENGESELLSCHAFT
Weismüllerstraße 3
D-60314 Frankfurt am Main
Deutschland/Germany/Allemagne

Frankfurt / Francfort, 2017-07-29

Im Namen des Herstellers/ On behalf of the Manufacturer/ Au nom du fabricant.

i. v. H. Zager

Hanno Zager
Leiter Qualitätssicherung/Head of Quality Management/
Responsable de l'assurance de la qualité

i. v. Dirk Hoffmann

Dirk Hoffmann
Zentralabteilungsleiter/Head of Department/Chef de département
Entwicklungsorganisation/Development Organization



SAMSON

**EU Konformitätserklärung / EU Declaration of Conformity /
Déclaration UE de conformité**

Die alleinige Verantwortung für die Ausstellung dieser Konformitätserklärung trägt der Hersteller/
This declaration of conformity is issued under the sole responsibility of the manufacturer/
La présente déclaration de conformité est établie sous la seule responsabilité du fabricant.
Für das folgende Produkt / For the following product / Nous certifions que le produit

**Elektropneumatischer Stellungsregler mit PROFIBUS-PA-Kommunikation /
Electropneumatic Positioner with PROFIBUS-PA communication /
Positionneur électropneumatique avec communication PROFIBUS-PA
Typ/Type/Type 3730-48..**

entsprechend der EU-Baumusterprüfbescheinigung PTB 05 ATEX 2010 X ausgestellt von der/
according to the EU Type Examination PTB 05 ATEX 2010 X issued by/
établi selon le certificat CE d'essais sur échantillons PTB 05 ATEX 2010 X émis par:

Physikalisch Technische Bundesanstalt
Bundesallee 100
D-38116 Braunschweig

Benannte Stelle/Notified Body/Organisme notifié 0102

wird die Konformität mit den einschlägigen Harmonisierungsrechtsvorschriften der Union bestätigt/
the conformity with the relevant Union harmonisation legislation is declared with/
est conforme à la législation d'harmonisation de l'Union applicable selon les normes:

EMC 2014/30/EU	EN 61000-6-2:2005, EN 61000-6-3:2007 +A1:2011, EN 61326-1:2013
Explosion Protection 94/9/EC (bis/to 2016-04-19) Explosion Protection 2014/34/EU (ab/from 2016-04-20)	EN 60079-15:2010, EN 60079-31:2009
RoHS 2011/65/EU	EN 50581:2012

Hersteller / Manufacturer / Fabricant:

SAMSON AKTIENGESELLSCHAFT
Weismüllerstraße 3
D-60314 Frankfurt am Main
Deutschland/Germany/Allemagne

Frankfurt / Francfort, 2017-07-29

Im Namen des Herstellers/ On behalf of the Manufacturer/ Au nom du fabricant.

Hanno Zager
Leiter Qualitätssicherung/Head of Quality Management/
Responsable de l'assurance de la qualité

Dirk Hoffmann
Zentralabteilungsleiter/Head of Department/Chef du département
Entwicklungsorganisation/Development Organization

ce_2730-48_d6_en_10_17_16_07.pdf

ЕВРАЗИЙСКИЙ ЭКОНОМИЧЕСКИЙ СОЮЗ



СЕРТИФИКАТ СООТВЕТСТВИЯ

№ ЕАЭС RU C-DE.ЭА11.В.00045/19

Серия **RU** № **0197354**

ОРГАН ПО СЕРТИФИКАЦИИ Общества с ограниченной ответственностью «ТМС РУС».
Место нахождения (адрес юридического лица): Российская Федерация, 127083, город Москва, улица Верхняя Масловка, дом 20, строение 2; адрес места осуществления деятельности: Российская Федерация, 127083, город Москва, улица Верхняя Масловка, дом 20, строение 2, помещения № 18, 28. Аттестат аккредитации № РОСС RU.0001.11ЭА11 от 02.07.2015. Номер телефона: +7 (495) 221-18-04; адрес электронной почты: info@tms-rs.ru.

ЗАЯВИТЕЛЬ Общество с ограниченной ответственностью «Самсон Контролс».
Место нахождения (адрес юридического лица) и адрес места осуществления деятельности: Российская Федерация, 109544, город Москва, бульвар Энтузиастов, дом 2, этаж 5, комната 11. ОГРН 1037700041026. Номер телефона: +7 (495) 777-45-45; адрес электронной почты: samson@samson.ru.

ИЗГОТОВИТЕЛЬ «SAMSON AG Mess- und Regeltechnik».
Место нахождения (адрес юридического лица) и адрес места осуществления деятельности по изготовлению продукции: Weismullerstrasse 3, D-60314 Frankfurt am Main, Германия.

ПРОДУКЦИЯ Позиционеры, типы 3724, 3725, 3730-0, 3730-1, 3730-2, 3730-3, 3730-4, 3730-5, 3730-6, 3731-3, 3731-5, 4763, 4765. Изготовление в соответствии со стандартами, указанными в приложении к сертификату соответствия на бланке № 0676628.
Серийный выпуск.

КОД ТН ВЭД ЕАЭС 9032 81 000 0

СООТВЕТСТВУЕТ ТРЕБОВАНИЯМ технического регламента Таможенного союза «Электромагнитная совместимость технических средств» (ТР ТС 020/2011)

СЕРТИФИКАТ СООТВЕТСТВИЯ ВЫДАН НА ОСНОВАНИИ протокола сертификационных испытаний № 190919-013-016-02/ИР от 22.10.2019, выданного испытательной лабораторией Общества с ограниченной ответственностью «Иновационные решения», аттестат аккредитации РОСС RU.0001.21AB90; акта о результатах анализа состояния производства № 00062-A от 04.07.2019 органа по сертификации Общества с ограниченной ответственностью «ТМС РУС»; руководств по эксплуатации 4218-3725-3724-2018.РЭ, 4218-3730-4763-2018.РЭ, 4218-3731-2018.РЭ.
Схема сертификации – 1с.

ДОПОЛНИТЕЛЬНАЯ ИНФОРМАЦИЯ Стандарт, в результате применения которого на добровольной основе обеспечивается соблюдение требований технического регламента: подразделы 6.2 и 7.2 ГОСТ Р 51522.1-2011 (МЭК 61326-1:2005) «Электрическое оборудование для измерения, управления и лабораторного применения. Часть 1. Общие требования и методы испытаний». Назначенный срок службы – 15 лет. Назначенный срок хранения – 2 года. Условия хранения указаны в руководстве по эксплуатации 4218-3725-3724-2018.РЭ, 4218-3730-4763-2018.РЭ, 4218-3731-2018.РЭ.

СРОК ДЕЙСТВИЯ С 05.11.2019 ПО 04.11.2024

ВКЛЮЧИТЕЛЬНО

Руководитель (уполномоченное лицо) органа по сертификации

(подпись)

Назарова Лилия Юрьевна
(Ф.И.О.)

Эксперт (эксперт-аудитор) (эксперты (эксперты-аудиторы))

(подпись)

Ходоров Владимир Игоревич
(Ф.И.О.)





(1) **EU-TYPE-EXAMINATION CERTIFICATE**
(Translation)

(2) Equipment or Protective Systems Intended for Use in
Potentially Explosive Atmospheres - **Directive 2014/34/EU**

(3) EU-Type Examination Certificate Number:

PTB 04 ATEX 2109

Issue: 1

(4) Product: Positioner, type 3730-41..., 3730-51..., 3730-45..., 3730-55...

(5) Manufacturer: SAMSON AG Mess- und Regeltechnik

(6) Address: Weismüllerstraße 3, 60314 Frankfurt, Germany

(7) This product and any acceptable variation thereto is specified in the schedule to this certificate and the documents therein referred to.

(8) The Physikalisch-Technische Bundesanstalt, notified body No. 0102 in accordance with Article 17 of the Directive 2014/34/EU of the European Parliament and of the Council, dated 26 February 2014, certifies that this product has been found to comply with the Essential Health and Safety Requirements relating to the design and construction of products intended for use in potentially explosive atmospheres, given in Annex II to the Directive.

The examination and test results are recorded in the confidential Test Report PTB Ex 17-25139.

(9) Compliance with the Essential Health and Safety Requirements has been assured by compliance with:

EN 60079-0:2012/A11:2013 EN 60079-11:2012 EN 60079-31:2014

(10) If the sign "X" is placed after the certificate number, it indicates that the product is subject to the Specific Conditions of Use specified in the schedule to this certificate.

(11) This EU-Type Examination Certificate relates only to the design and construction of the specified product in accordance to the Directive 2014/34/EU. Further requirements of the Directive apply to the manufacturing process and supply of this product. These are not covered by this certificate.

(12) The marking of the product shall include the following:

 **II 2 G Ex ia IIC T6...T4 Gb and II 2 D Ex ia IIIC T80 °C Db or
II 2 D Ex tb IIIC T80 °C Db**

Konformitätsbewertungsstelle, Sektor Explosionsschutz

Braunschweig, May 11, 2017

On behalf of PTB:

ZSE001e c

Dr.-Ing. F. Liesche
Regierungsdirektor



sheet 1/7

EU-Type Examination Certificates without signature and official stamp shall not be valid. The certificates may be circulated only without alteration. Extracts or alterations are subject to approval by the Physikalisch-Technische Bundesanstalt. In case of dispute, the German text shall prevail.

Physikalisch-Technische Bundesanstalt • Bundesallee 100 • 38116 Braunschweig • GERMANY

(13)

SCHEDULE

(14) **EU-Type Examination Certificate Number PTB 04 ATEX 2109, Issue: 1**

(15) Description of Product

The positioners of types 3730-41..., 3730-51..., 3730-45... and 3730-55... are communication-capable, bus-powered field devices which are used to assign a valve position to a control signal.

The bus interface connection (bus-coupling) can be performed according to the FISCO-concept for both specifications, Profibus PA and Foundation™ Fieldbus.

They are mounted onto levitation and slewing actuators. Non-flammable media are used as pneumatic auxiliary power. The equipment is intended for the application inside the hazardous area.

Thermal and electrical maximum values

Type 3730-41 and 3730-51:

For relationship between temperature class and permissible ranges of the ambient temperature, reference is made to the following table:

Gas- or dust group	Temperature class	Permissible ambient temperature range
IIC	T6	-55 °C ... 60 °C
	T5	-55 °C ... 70 °C
	T4	-55 °C ... 80 °C
IIIC	not applicable	-55 °C ... 80 °C

For relationship between temperature class, permissible ranges of the ambient temperature, maximum short-circuit currents and maximum power for analyzing units with limit contacts (terminals 41/42), reference is made to the following table:

sheet 2/7

EU-Type Examination Certificates without signature and official stamp shall not be valid. The certificates may be circulated only without alteration. Extracts or alterations are subject to approval by the Physikalisch-Technische Bundesanstalt. In case of dispute, the German text shall prevail.

Physikalisch-Technische Bundesanstalt • Bundesallee 100 • 38116 Braunschweig • GERMANY

SCHEDULE TO EU-TYPE EXAMINATION CERTIFICATE PTB 04 ATEX 2109, Issue: 1

Temperature class	Permissible ambient temperature range	I_0 / P_0
T6	-55 °C ... 45 °C	52 mA / 169 mW
T5	-55 °C ... 60 °C	
T4	-55 °C ... 75 °C	
T6	-55 °C ... 60 °C	25 mA / 64 mW
T5	-55 °C ... 80 °C	
T4	-55 °C ... 80 °C	

BUS-connection-signal circuittype of protection Intrinsic Safety Ex ia IIC / IIB / IIIC
 (terminals 11/12) only for connection to a certified intrinsically safe circuit

For relationship between type of protection and electrical data, reference is made to the following table:

Maximum values:

FISCO power supply	FIELDBUS power supply general	
Ex ia IIC / IIB / IIIC	Ex ia IIC / IIIC	Ex ia IIB / IIIC
$U_i = 17,5 \text{ V DC}$	$U_i = 24 \text{ V DC}$	$U_i = 24 \text{ V DC}$
$I_i = 380 \text{ mA}$	$I_i = 360 \text{ mA}$	$I_i = 380 \text{ mA}$
$P_i = 5,32 \text{ W}$	$P_i = 1,04 \text{ W}$	$P_i = 2,58 \text{ W}$

$C_i = 5 \text{ nF}$
 $L_i = 10 \text{ } \mu\text{H}$

Limit contact, inductivetype of protection Intrinsic Safety Ex ia IIC / IIIC
 (terminals 41/42) only for connection to a certified intrinsically safe circuit

Maximum values:

$U_i = 16 \text{ V}$
 $I_i = 52 \text{ mA}$
 $P_i = 169 \text{ mW}$
 $C_i = 60 \text{ nF}$
 $L_i = 100 \text{ } \mu\text{H}$
 resp.

sheet 3/7

EU-Type Examination Certificates without signature and official stamp shall not be valid. The certificates may be circulated only without alteration. Extracts or alterations are subject to approval by the Physikalisch-Technische Bundesanstalt. In case of dispute, the German text shall prevail.

Physikalisch-Technische Bundesanstalt • Bundesallee 100 • 38116 Braunschweig • GERMANY

SCHEDULE TO EU-TYPE EXAMINATION CERTIFICATE PTB 04 ATEX 2109, Issue: 1

$U_i = 16 \text{ V}$
 $I_i = 25 \text{ mA}$
 $P_i = 64 \text{ mW}$
 $C_i = 60 \text{ nF}$
 $L_i = 100 \text{ }\mu\text{H}$

Forced deaeration.....type of protection Intrinsic Safety Ex ia IIC / IIIC
 (terminals 81/82) only for connection to a certified intrinsically safe circuit

Maximum values:

$U_i = 28 \text{ V}$
 $I_i = 115 \text{ mA}$
 $C_i = 5.3 \text{ nF}$
 L_i negligibly low

Binary input 1.....type of protection Intrinsic Safety Ex ia IIC / IIIC
 (terminals 87/88) for connection to an active contact circuit

Maximum values:

$U_i = 30 \text{ V}$
 $I_i = 100 \text{ mA}$
 C_i negligibly low
 L_i negligibly low

Binary input 2.....type of protection Intrinsic Safety Ex ia IIC / IIB / IIIC
 (terminals 85/86) only for connection to a passive floating contact circuit

Maximum values:

$U_o = 5.88 \text{ V}$
 $I_o = 1 \text{ mA}$
 $P_o = 7.2 \text{ mW}$

For relationship between explosion group and permissible external capacitances and inductances, reference is made to the following table:

Ex ia IIC / IIIC	Ex ia IIB / IIIC
$C_o = 2 \text{ }\mu\text{F}$	$C_o = 16 \text{ }\mu\text{F}$
$L_o = 10 \text{ mH}$	$L_o = 1 \text{ H}$

sheet 4/7

EU-Type Examination Certificates without signature and official stamp shall not be valid. The certificates may be circulated only without alteration. Extracts or alterations are subject to approval by the Physikalisch-Technische Bundesanstalt. In case of dispute, the German text shall prevail.

Physikalisch-Technische Bundesanstalt • Bundesallee 100 • 38116 Braunschweig • GERMANY

SCHEDULE TO EU-TYPE EXAMINATION CERTIFICATE PTB 04 ATEX 2109, Issue: 1

C_i negligibly low
 L_i negligibly low

Serial Interfacetype of protection Intrinsic Safety Ex ia IIC / IIB / IIIC
(programming socket BU)

Maximum values:

$U_o = 8.61$ V
 $I_o = 55$ mA
 $P_o = 250$ mW

For relationship between type of protection and permissible external capacitances and inductances, reference is made to the following table:

Ex ia IIC / IIIC	Ex ia IIB / IIIC
$C_o = 0.61$ μ F	$C_o = 4$ μ F
$L_o = 9$ mH	$L_o = 9$ mH

resp.

only for connection to a certified intrinsically safe circuit

Maximum values:

$U_i = 16$ V
 $I_i = 25$ mA
 $P_i = 64$ mW

C_i negligibly low
 L_i negligibly low

External position sensortype of protection Intrinsic Safety Ex ia IIC / IIIC
(analog circuit board, pins p9, p10, p11)

Maximum values:

$U_o = 8.61$ V
 $I_o = 55$ mA
 $P_o = 250$ mW

For relationship between type of protection and permissible external capacitances and inductances, reference is made to the following table:

sheet 5/7

EU-Type Examination Certificates without signature and official stamp shall not be valid. The certificates may be circulated only without alteration. Extracts or alterations are subject to approval by the Physikalisch-Technische Bundesanstalt. In case of dispute, the German text shall prevail.

Physikalisch-Technische Bundesanstalt • Bundesallee 100 • 38116 Braunschweig • GERMANY

SCHEDULE TO EU-TYPE EXAMINATION CERTIFICATE PTB 04 ATEX 2109, Issue: 1

Ex ia IIC / IIIC	Ex ia IIB / IIIC
$C_o = 0.61 \mu\text{F}$	$C_o = 4 \mu\text{F}$
$L_o = 9 \text{ mH}$	$L_o = 9 \text{ mH}$

$C_i = 730 \text{ nF}$
 $L_i = 370 \text{ }\mu\text{H}$

Type 3730-45... und 3730-55...:

The permissible range of the ambient temperature for dust groupe IIIC is $-55 \text{ }^\circ\text{C} \dots 80 \text{ }^\circ\text{C}$.

BUS-connection signal circuitNominal signal:	24 V DC
(Terminals 11/12).....Rated voltage:	28 V
Binary input 1.....Nominal signal:	6 ... 30 V DC
(Terminals 87/88)Rated voltage:	30 V
Binary input 2.....only for connection to a passive floating (Terminals 85/86).....contact circuit	
Limit contact, inductiveNominal signal:	8 V DC, 8 mA
(Terminals 41/42)Rated voltage:	16 V
Forced deaeration.....Nominal signal:	6 ... 24 V DC
(Terminals 81/82)Rated voltage:	28 V

Changes against previous issue:

The changes concern the update of the applied standards, the electrical data, the adding of another type notation for dust ignition protection by enclosure, the implementation of dust ignition protection by Intrinsic Safety, the application of alternative gasket material of the enclosure and alternative construction of the enclosure.

(16) Test Report PTB Ex17-25139

(17) Specific conditions of use
none

sheet 6/7

EU-Type Examination Certificates without signature and official stamp shall not be valid. The certificates may be circulated only without alteration. Extracts or alterations are subject to approval by the Physikalisch-Technische Bundesanstalt. In case of dispute, the German text shall prevail.

Physikalisch-Technische Bundesanstalt • Bundesallee 100 • 38116 Braunschweig • GERMANY



SCHEDULE TO EU-TYPE EXAMINATION CERTIFICATE PTB 04 ATEX 2109, Issue: 1

(18) Essential health and safety requirements

Met by compliance with the aforementioned standards.

According to Article 41 of Directive 2014/34/EU, EC-type examination certificates which have been issued according to Directive 94/9/EC prior to the date of coming into force of Directive 2014/34/EU (April 20, 2016) may be considered as if they were issued already in compliance with Directive 2014/34/EU. By permission of the European Commission supplements to such EC-type examination certificates and new issues of such certificates may continue to hold the original certificate number issued before April 20, 2016.

Konformitätsbewertungsstelle, Sektor Explosionsschutz

Braunschweig, May 11, 2017

On behalf of PTB:

Dr.-Ing. F. Lienesch
Regierungsdirektor

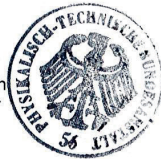

sheet 7/7

EU-Type Examination Certificates without signature and official stamp shall not be valid. The certificates may be circulated only without alteration. Extracts or alterations are subject to approval by the Physikalisch-Technische Bundesanstalt. In case of dispute, the German text shall prevail.

Physikalisch-Technische Bundesanstalt • Bundesallee 100 • 38116 Braunschweig • GERMANY



CONFORMITY STATEMENT (Translation)

(1)

(2) Equipment and Protective Systems Intended for Use in
Potentially Explosive Atmospheres - **Directive 2014/34/EU**

(3) Test Certificate Number:

PTB 05 ATEX 2010 X

Issue: 1

(4) Product:

Positioner type 3730-48... and 3730-58...

(5) Manufacturer:

SAMSON AG Mess- und Regeltechnik

(6) Address:

Weismüllerstraße 3, 60314 Frankfurt, Germany

(7) This product and any acceptable variation thereto are specified in the schedule to this certificate and the documents therein referred to.

(8) The Physikalisch-Technische Bundesanstalt, notified body No. 0102 in accordance with Article 17 of the Directive 2014/34/EU of the European Parliament and of the Council, dated 26 February 2014, certifies that this product has been found to comply with the Essential Health and Safety Requirements relating to the design and construction of products intended for use in potentially explosive atmospheres, given in Annex II to the Directive.

The examination and test results are recorded in the confidential test report PTB Ex 17-25140.

(9) Compliance with the Essential Health and Safety Requirements has been assured by compliance with:

EN 60079-0:2012/A11:2013 EN 60079-15:2010 EN 60079-31:2014

(10) If the sign "X" is placed after the certificate number, it indicates that the product is subject to special conditions for safe use specified in the schedule to this certificate.

(11) This Conformity Statement relates only to the design and construction of the specified product in accordance with Directive 2014/34/EU. Further requirements of this Directive apply to the manufacture and supply of this product.

(12) The marking of the product shall include the following:

Ex II 3 G Ex nA IIC T6 Gc bzw. II 3 D Ex tc IIIC T80 °C Dc

Konformitätsbewertungsstelle, Sektor Explosionsschutz

Braunschweig, June 22, 2017

On behalf of PTB



Dr.-Ing. F. Liensich
Regierungsdirektor



Sheet 1/3

Conformity Statements without signature and official stamp shall not be valid. The certificates may be circulated only without alteration. Extracts or alterations are subject to approval by the Physikalisch-Technische Bundesanstalt. In case of dispute, the German text shall prevail.

Physikalisch-Technische Bundesanstalt • Bundesallee 100 • 38116 Braunschweig • GERMANY

(13)

SCHEDULE

(14) **CONFORMITY STATEMENT PTB 05 ATEX 2010 X, Ausgabe: 1**

(15) Description of the product

The positioners of types 3730-48... and 3730-58... are communication-capable, bus-powered field devices which are used to assign a valve position to a control signal.

They are mounted onto levitation and slewing actuators. Non-flammable media are used as pneumatic auxiliary power. The equipment is intended for the application inside the hazardous area.

Thermal and electrical maximum values:

The permissible ambient temperature range for dust group IIIC is between -55 °C ... 80 °C.

For the relationship between temperature class and permissible ranges of the ambient temperature for gas group IIC reference is made to the following table:

Temperature class	permissible ambient temperature range
T6	-55 °C ... 60 °C
T5	-55 °C ... 70 °C
T4	-55 °C ... 80 °C

BUS-connection signal circuitNominal signal: 24 V DC
 (Terminals 11/12) Rated voltage: 28 V

Binary input 1Nominal signal: 6 ... 30 V DC
 (Terminals 87/88) Rated voltage: 30 V

Binary input 2only for connection to a passive floating
 (Terminals 85/86) contact circuit

Limit contact, inductiveNominal signal: 8 V DC, 8 mA
 (Terminals 41/42) Rated voltage: 16 V

Forced deaerationNominal signal: 6 ... 24 V DC
 (Terminals 81/82) Rated voltage: 28 V

Sheet 2/3

Conformity Statements without signature and official stamp shall not be valid. The certificates may be circulated only without alteration. Extracts or alterations are subject to approval by the Physikalisch-Technische Bundesanstalt. In case of dispute, the German text shall prevail.

Physikalisch-Technische Bundesanstalt • Bundesallee 100 • 38116 Braunschweig • GERMANY



SCHEDULE TO EU-TYPE EXAMINATION CERTIFICATE PTB 05 ATEX 2010 X, Issue: 1

Changes against previous issue:

The changes concern the update of the applied standards, the electrical data, the cancelation of type of protection "nL", the adding of dust ignition protection by enclosure, the application of alternative gasket material of the enclosure and alternative construction of the enclosure.

(16) Test report PTB Ex 17-25139

(17) Specific conditions of use

The program-interface intended for connection to the positioners of types 3730-48... and 3730-58... shall be installed outside of the hazardous area.

For type of protection "nA" applies:

If the program-interface adaptor is connected to a circuit of type of protection "nA" a fuse according to IEC 60127-2/II, 250 V F or according to IEC 60127-2/VI, 250 V T with a nominal fuse current of max. $I_N \leq 40$ mA shall be connected in series to the Vcc-circuit. The fuse shall be arranged outside of the hazardous area.

(18) Essential health and safety requirements

Met by compliance with the aforementioned harmonized standards.

According to Article 41 of Directive 2014/34/EU, Conformity Statements which have been issued according to Directive 94/9/EC prior to the date of coming into force of Directive 2014/34/EU (April 20, 2016) may be considered as if they were issued already in compliance with Directive 2014/34/EU. By permission of the European Commission supplements to such Conformity Statements and new issues of such certificates may continue to hold the original certificate number issued before April 20, 2016.

Konformitätsbewertungsstelle, Sektor Explosionsschutz
On behalf of PTB

Braunschweig, June 22, 2017

Dr.-Ing. F. Lienisch
Regierungsdirektor



Sheet 3/3

Conformity Statements without signature and official stamp shall not be valid. The certificates may be circulated only without alteration. Extracts or alterations are subject to approval by the Physikalisch-Technische Bundesanstalt. In case of dispute, the German text shall prevail.

Physikalisch-Technische Bundesanstalt • Bundesallee 100 • 38116 Braunschweig • GERMANY



IECEX Certificate of Conformity

INTERNATIONAL ELECTROTECHNICAL COMMISSION IEC Certification Scheme for Explosive Atmospheres

for rules and details of the IECEX Scheme visit www.iecex.com

Certificate No.: IECEX PTB 06.0054X Issue No: 1 Certificate history:
Issue No. 1 (2017-07-17)
Issue No. 0 (2006-11-02)

Status: **Current** Page 1 of 5

Date of Issue: 2017-07-17

Applicant: **SAMSON AG Mess- und Regeltechnik**
Weismuellerstrasse 3
D-60314 Frankfurt am Main
Germany

Equipment: **Bus-powered field I/p-Positioners types 3730-41..., 3730-51..., 3730-45..., 3730-55...,
3730-48... and 3730-58...**

Optional accessory:

Type of Protection: **General Requirements, Intrinsic Safety "i", Equipment protection by type of protection "n", Equipment dust ignition
protection by enclosure "t"**

Marking:
Ex ia IIC T6...T4 Gb and Ex ia IIIC T80 °C Db
or
Ex tb IIIC T80 °C Db
or
Ex nA IIC T6...T4 Gc and Ex tc IIIC T80 °C Dc

Approved for issue on behalf of the IECEX
Certification Body:

Dr.-Ing. Frank Lienesch

Position:

Head of Department "Explosion Protection in Sensor Technology and
Instrumentation"

Signature:
(for printed version)

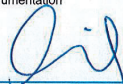

24.7.17

Date:

1. This certificate and schedule may only be reproduced in full.
2. This certificate is not transferable and remains the property of the issuing body.
3. The Status and authenticity of this certificate may be verified by visiting the Official IECEX Website.

Certificate issued by:

Physikalisch-Technische Bundesanstalt (PTB)
Bundesallee 100
38116 Braunschweig
Germany





IECEx Certificate of Conformity

Certificate No: IECEx PTB 06.0054X Issue No: 1
Date of Issue: 2017-07-17 Page 2 of 5
Manufacturer: SAMSON AG Mess- und Regeltechnik
Weismuellerstrasse 3
D-60314 Frankfurt am Main
Germany

Additional Manufacturing location(s):

This certificate is issued as verification that a sample(s), representative of production, was assessed and tested and found to comply with the IEC Standard list below and that the manufacturer's quality system, relating to the Ex products covered by this certificate, was assessed and found to comply with the IECEx Quality system requirements. This certificate is granted subject to the conditions as set out in IECEx Scheme Rules, IECEx 02 and Operational Documents as amended.

STANDARDS:

The electrical apparatus and any acceptable variations to it specified in the schedule of this certificate and the identified documents, was found to comply with the following standards:

IEC 60079-0 : 2011 Edition:6.0	Explosive atmospheres - Part 0: General requirements
IEC 60079-11 : 2011 Edition:6.0	Explosive atmospheres - Part 11: Equipment protection by intrinsic safety "I"
IEC 60079-15 : 2010 Edition:4	Explosive atmospheres - Part 15: Equipment protection by type of protection "n"
IEC 60079-31 : 2013 Edition:2	Explosive atmospheres - Part 31: Equipment dust ignition protection by enclosure "T"

This Certificate does not indicate compliance with electrical safety and performance requirements other than those expressly included in the Standards listed above.

TEST & ASSESSMENT REPORTS:

A sample(s) of the equipment listed has successfully met the examination and test requirements as recorded in

Test Report:

[DE/PTB/ExTR06.0088/00](#) [DE/PTB/ExTR06.0088/01](#)

Quality Assessment Report:

[DE/TUN/QAR06.0011/06](#)



IECEx Certificate of Conformity

Certificate No: IECEX PTB 06.0054X

Issue No: 1

Date of Issue: 2017-07-17

Page 3 of 5

Schedule

EQUIPMENT:

Equipment and systems covered by this certificate are as follows:

The positioners type 3730-41..., 3730-51..., 3730-45... and 3730-55... are communication-capable, bus-powered field devices which are used to assign a valve position to a control signal. The bus interface connection (bus-coupling) can be performed according to the FISCO-concept for both specifications, Profibus PA and FoundationTM Fieldbus. They are mounted onto levitation and slewing actuators. Non-flammable media are used as pneumatic auxiliary power. The equipment is intended for the application inside the hazardous area.

The positioners type 3730-48... and 3730-58... are communication-capable, bus-powered field devices which are used to assign a valve position to a control signal. They are mounted onto levitation and slewing actuators. Non-flammable media are used as pneumatic auxiliary power. The equipment is intended for the application inside the hazardous area.

For further information see annexe.

SPECIFIC CONDITIONS OF USE: YES as shown below:

The program-interface intended for connection to the positioners of types 3730-48... and 3730-58... shall be installed outside of the hazardous area.

For type of protection "nA" applies:

If the program-interface adaptor is connected to a circuit of type of protection "nA" a fuse according to IEC 60127-2/II, 250 V F or according to IEC 60127-2/VI, 250 V T with a nominal fuse current of max. $I_N \leq 40$ mA shall be connected in series to the Vcc-circuit. The fuse shall be arranged outside of the hazardous area.



IECEX Certificate of Conformity

Certificate No: IECEX PTB 06.0054X

Issue No: 1

Date of Issue: 2017-07-17

Page 4 of 5

DETAILS OF CERTIFICATE CHANGES (for Issues 1 and above):

The changes concern the update of the applied standards, the electrical data, the adding of dust ignition protection by enclosure, the adding of dust ignition protection by Intrinsic Safety, the adding of Equipment protection by type of protection "nA", the adding of new types and the inner construction.



IECEX Certificate of Conformity

Certificate No: IECEX PTB 06.0054X

Issue No: 1

Date of Issue: 2017-07-17

Page 5 of 5

Additional Information:

for further information see annex

Annex:

[Annex IECEX PTB 06.0054X-01.pdf](#)



Applicant's name.....: SAMSON AG Mess und-Regeltechnik
 Address: Weismüllerstrasse 3; 60314 Frankfurt, Germany
 Model/type reference: Types 3730-41..., 3730-51..., 3730-45..., 3730-55...,
 3730-48... and 3730-58...

Thermal and electrical maximum values

Type 3730-41 and 3730-51:

For relationship between temperature class and permissible ranges of the ambient temperature, reference is made to the following table:

Gas- or dust group	Temperature class	Permissible ambient temperature range
IIC	T6	-55 °C ... 60 °C
	T5	-55 °C ... 70 °C
	T4	-55 °C ... 80 °C
IIIC	not applicable	-55 °C ... 80 °C

For relationship between temperature class, permissible ranges of the ambient temperature, maximum short-circuit currents and maximum power for analyzing units with limit contacts (terminals 41/42), reference is made to the following table:

Temperature class	Permissible ambient temperature range	I_0 / P_0
T6	-55 °C ... 45 °C	52 mA / 169 mW
T5	-55 °C ... 60 °C	
T4	-55 °C ... 75 °C	
T6	-55 °C ... 60 °C	25 mA / 64 mW
T5	-55 °C ... 80 °C	
T4	-55 °C ... 80 °C	

BUS-connection-signal circuit type of protection Intrinsic Safety Ex ia IIC / IIB / IIIC (terminals 11/12) only for connection to a certified intrinsically safe circuit

For relationship between type of protection and electrical data, reference is made to the following table:



Maximum values:

FISCO power supply	FIELDBUS power supply general	
	Ex ia IIC / IIB / IIIC	Ex ia IIB / IIIC
$U_i = 17,5 \text{ V DC}$	$U_i = 24 \text{ V DC}$	$U_i = 24 \text{ V DC}$
$I_i = 380 \text{ mA}$	$I_i = 360 \text{ mA}$	$I_i = 380 \text{ mA}$
$P_i = 5,32 \text{ W}$	$P_i = 1,04 \text{ W}$	$P_i = 2,58 \text{ W}$

$C_i = 5 \text{ nF}$
 $L_i = 10 \text{ } \mu\text{H}$

Limit contact, inductive type of protection Intrinsic Safety Ex ia IIC / IIIC
(terminals 41/42) only for connection to a certified intrinsically safe circuit

Maximum values:

$U_i = 16 \text{ V}$
 $I_i = 52 \text{ mA}$
 $P_i = 169 \text{ mW}$
 $C_i = 60 \text{ nF}$
 $L_i = 100 \text{ } \mu\text{H}$

resp.

$U_i = 16 \text{ V}$
 $I_i = 25 \text{ mA}$
 $P_i = 64 \text{ mW}$
 $C_i = 60 \text{ nF}$
 $L_i = 100 \text{ } \mu\text{H}$

Forced deaeration type of protection Intrinsic Safety Ex ia IIC / IIIC
(terminals 81/82) only for connection to a certified intrinsically safe circuit

Maximum values:

$U_i = 28 \text{ V}$
 $I_i = 115 \text{ mA}$
 $C_i = 5.3 \text{ nF}$
 L_i negligibly low

Binary input 1 type of protection Intrinsic Safety Ex ia IIC / IIIC
(terminals 87/88) for connection to an active contact circuit

Maximum values:

$U_i = 30 \text{ V}$
 $I_i = 100 \text{ mA}$
 C_i negligibly low
 L_i negligibly low



Binary input 2 type of protection Intrinsic Safety Ex ia IIC / IIB / IIC
(terminals 85/86)

only for connection to a passive floating contact circuit

Maximum values:

$U_o = 5.88 \text{ V}$
 $I_o = 1 \text{ mA}$
 $P_o = 7.2 \text{ mW}$

For relationship between explosion group and permissible external capacitances and inductances, reference is made to the following table:

Ex ia IIC / IIC	Ex ia IIB / IIC
$C_o = 2 \mu\text{F}$	$C_o = 16 \mu\text{F}$
$L_o = 10 \text{ mH}$	$L_o = 1 \text{ H}$

C_i negligibly low
 L_i negligibly low

Serial Interface type of protection Intrinsic Safety Ex ia IIC / IIB / IIC
(programming socket BU)

Maximum values:

$U_o = 8.61 \text{ V}$
 $I_o = 55 \text{ mA}$
 $P_o = 250 \text{ mW}$

For relationship between type of protection and permissible external capacitances and inductances, reference is made to the following table:

Ex ia IIC / IIC	Ex ia IIB / IIC
$C_o = 0.61 \mu\text{F}$	$C_o = 4 \mu\text{F}$
$L_o = 9 \text{ mH}$	$L_o = 9 \text{ mH}$

resp.

only for connection to a certified intrinsically safe circuit

Maximum values:

$U_i = 16 \text{ V}$
 $I_i = 25 \text{ mA}$
 $P_i = 64 \text{ mW}$



C_i negligibly low
 L_i negligibly low

External position sensor type of protection Intrinsic Safety Ex ia IIC / IIIC
(analog circuit board, pins p9, p10, p11)

Maximum values:

$U_o = 8.61$ V
 $I_o = 55$ mA
 $P_o = 250$ mW

For relationship between type of protection and permissible external capacitances and inductances, reference is made to the following table:

Ex ia IIC / IIIC	Ex ia IIB / IIIC
$C_o = 0.61$ μ F	$C_o = 4$ μ F
$L_o = 9$ mH	$L_o = 9$ mH

$C_i = 730$ nF
 $L_i = 370$ μ H

Type 3730-45... und 3730-55...:

The permissible range of the ambient temperature for dust groupe IIIC is -55 °C ... 80 °C.

BUS-connection signal circuitNominal signal: 24 V DC
(Terminals 11/12)Rated voltage: 28 V

Binary input 1Nominal signal: 6 ... 30 V DC
(Terminals 87/88)Rated voltage: 30 V

Binary input 2only for connection to a passive floating
(Terminals 85/86)contact circuit

Limit contact, inductiveNominal signal: 8 V DC, 8 mA
(Terminals 41/42)Rated voltage: 16 V

Forced deaerationNominal signal: 6 ... 24 V DC
(Terminals 81/82)Rated voltage: 28 V

3730-48... and 3730-58...:

The permissible ambient temperature range for dust group IIIC is between -55 °C ... 80 °C.

For the relationship between temperature class and permissible ranges of the ambient temperature for gas group IIC reference is made to the following table:



Temperature class	permissible ambient temperature range
T6	-55 °C ... 60 °C
T5	-55 °C ... 70 °C
T4	-55 °C ... 80 °C

BUS-connection signal circuit (Terminals 11/12)	Nominal signal: Rated voltage:	24 V DC 28 V
Binary input 1 (Terminals 87/88)	Nominal signal: Rated voltage:	6 ... 30 V DC 30 V
Binary input 2 (Terminals 85/86)	only for connection to a passive floating contact circuit	
Limit contact, inductive (Terminals 41/42)	Nominal signal: Rated voltage:	8 V DC, 8 mA 16 V
Forced deaeration (Terminals 81/82)	Nominal signal: Rated voltage:	6 ... 24 V DC 28 V



FM Approvals
1151 Boston-Providence Turnpike
P.O. Box 9102 Norwood, MA 02062 USA
T: 781 762 4300 F: 781 762 9375 www.fmglobal.com

CERTIFICATE OF COMPLIANCE

HAZARDOUS (CLASSIFIED) LOCATION ELECTRICAL EQUIPMENT

This certificate is issued for the following equipment:

3730-43-abcdef. Profibus PA Positioner

3730-53-abcdef. Foundation FF Positioner

IS / I,II,III / 1 / ABCDEFG / T6 Ta = 60°C - Addendum to EB Addendum to EB 8384-5 EN, pages 7 to 12; Entity/FISCO; Type 4X

I / 0 / AEx ia IIC / T6 Ta = 60°C - Addendum to EB 8384-5 EN, pages 7 to 12; Type 4X

NI / I / 2 / ABCD / T6 Ta = 60°C - Addendum to EB 8384-5 EN, pages 10 to 12; Nonincendive Field

Wiring/FNINCO; Type 4X; S / II,III / 2 / FG / T6 Ta = 60°C; Type 4X

I / 2 / Ex nA / nL IIC / T6 Ta = 60°C - Addendum to EB 8384-5 EN, pages 10 to 12; Nonincendive Field Wiring/FNINCO; Type 4X

Entity/FISCO Parameters:

Foundation-Fieldbus Signal Terminals Group A/B (IIC)

V_{max} (Ui) = 24V, I_{max} (Ii) = 360mA, P_{max} (Pi) = 1.04W, Ci = 5nF, Li = 10μH

Profibus-Fieldbus Signal Terminals Group C, D (IIB)

V_{max} (Ui) = 24V, I_{max} (Ii) = 380mA, P_{max} (Pi) = 2.58W, Ci = 5nF, Li = 10μH

Profibus-Fieldbus Signal Circuit Terminals Group A/B (IIC)

V_{max} (Ui) = 17.5Vdc, I_{max} (Ii) = 380mA, P_{max} (Pi) = 5.32W, Ci = 5nF, Li = 10μH

Nonincendive Field Wiring/FNINCO Parameters:

Foundation-Fieldbus Signal Terminals Group A/B (IIC)

V_{max} (Ui) = 30V or 32V, I_{max} (Ii) = 152mA or 130mA, P_{max} (Pi) = 1.14W, Ci = 5nF, Li = 10μH

Profibus-Fieldbus Signal Terminals Group C, D (IIB)

V_{max} (Ui) = 30V or 32V, I_{max} (Ii) = 379mA or 324mA, P_{max} (Pi) = 3.85W or 2,77W, Ci = 5nF, Li = 10μH

Inputs & Outputs:

Limit Switches Terminals (Entity/FISCO):

V_{max} (Ui) = 16V, I_{max} (Ii) = 25mA, P_{max} (Pi) = 64mW, Ci = 30nF, Li = 100μH

V_{max} (Ui) = 16V, I_{max} (Ii) = 52mA, P_{max} (Pi) = 169mW, Ci = 30nF, Li = 100μH

Limit Switches Terminals (Nonincendive Field Wiring/FNINCO):

V_{max} (Ui) = 20V, I_{max} (Ii) = 25mA, P_{max} (Pi) = 64mW, Ci = 60nF, Li = 100μH

Force Venting Function Terminals 81/82 (Entity/FISCO):

V_{max} (Ui) = 28V, I_{max} (Ii) = 115mA, P_{max} (Pi) = 0.5W, Ci = 5.3nF, Li = 0



Force Venting Function Terminals 81/82 (Nonincendive Field Wiring/FNINCO):
Vmax (Ui) = 30V, Imax (Ii) = 100mA, Pmax (Pi) = 0.75W, Ci = 5.3nF, Li = 0

Binary Inputs 1 & 2 Terminals (Entity/FISCO/Nonincendive Field Wiring/ FNINCO):
Vmax (Ui) = 30V, Imax (Ii) = 100mA, Pmax (Pi) = 0.75W, Ci = 0, Li = 0
Voc (Ui) = 5.88V, Imax (Ii) = 1mA, Pmax (Pi) = 7.2mW, Ca = 2µF, La = 10mH

Serial Interface Active & Passive Plugs (Entity/FISCO/Nonincendive Field Wiring/ FNINCO):
Voc (Ui) = 8.61V, Isc (Ii) = 55mA, Pmax (Pi) = 250mW, Ca = 0.61µF, La = 9mH
Vmax (Ui) = 16V, Isc (Ii) = 25mA, Pmax (Pi) = 64mW, Ci = 0, Li = 0

a = Inductive proximity switches: 0 (without proximity switch) or 1 (with proximity switch).
b = Force venting function (solenoid Valve): 0 (not provided) or 4 (provided).
c = Vibration Sensor: 0 (not provided) or 2 (provided).
d = Binary input: 0 (not provided) or 3 (provided).
e = External position sensor: 0 (not provided) or 1 (provided).
f = Connections: Pneumatic connections, electrical connections, 1+2 m 20 x1.5 (plastic) or 1 + 5 = M 20 x 1.5 (metal).

Equipment Ratings:

evaluated as Intrinsically Safe electrical apparatus with Entity/FISCO parameters for use in Class I, II, III, Division 1, Groups A, B, C, D, E, F and G; alternatively for Class I, Zone 0, AEx ia Group IIC; Temperature Class T6 Ta = 60°C in accordance with control drawing Addendum to EB 8384-5 EN, pages 7 to 12; Nonincendive electrical apparatus with nonincendive field wiring/FNINCO for use in Class I, Division 2, Groups A, B, C and D; Suitable for Class II,III, Division 2, Groups F and G Temperature Class T6 Ta = 60°C; alternatively for Class I, Zone 2, Ex nA / nL Group IIC; Temperature Class T6 Ta = 60°C in accordance with control drawing Addendum to EB 8384-5 EN, pages 10 to 12; indoor/outdoor Type 4X hazardous (classified) Locations.

Approved for:

Samson AG
Postfach 101901 D-60314 Frankfurt, Germany



This certifies that the equipment described has been found to comply with the following FM Approval Standards and other documents:

Class 3600	1998
Class 3610	1999
Class 3611	2004
Class 3810	2005
ANSI/NEMA 250	1991

Original Project ID: 3023605

FM Approval Granted: September 5, 2005

Subsequent Revision Reports / Date FM Approval Amended

Report Number	Date	Report Number	Date
3025274	October 26, 2005		

FM Global Technologies LLC

Timothy Adam
Technical Team Manager
FM Approvals

31st October, 2005
Date



Certificate of Compliance

Certificate: 1675787

Master Contract: 173246 (LR 54227)

Project: 70069173

Date Issued: 2017-05-24

Issued to: Samson AG
Mess- Und Regeltechnik
Department E71
Weismuellerstrasse 3
Frankfurt, 60314
GERMANY
Attention: Tomislav Varga

The products listed below are eligible to bear the CSA Mark shown



Issued by:

R Papiah

PRODUCTS

CLASS 2258 04 – PROCESS CONTROL EQUIPMENT - Inherently Safe, Entity - For Hazardous Locations

Ex ia IIC T6

Class I, Division 1, Groups A, B, C and D; Class II, Division 1, Groups E, F and G, Class III, Type 4 Enclosure

Model 3730-43 PROFIBUS PA Positioner, Temperature Code T6 at ambient of -40°C to +60°C, T5 at -40°C to +70°C, T4 at -40°C to +80°C; Inherently safe when installed per Samson AG installation drawing EB8384-5 EN.



Certificate: 1675787
Project: 70069173

Master Contract: 173246 (LR 54227)
Date Issued: 2017-05-24

CLASS 2258 03 - PROCESS CONTROL EQUIPMENT - Intrinsically Safe and Non-Incendive Systems - For Hazardous Locations

Ex nL IIC T6

Class I, Division 2, Groups A, B, C and D; Class II, Division 1, Groups E, F and G; Class III; Type 4 Enclosure

Model 3730-43 PROFIBUS PA Positioner, Temperature Code T6 at ambient of -40°C to +60°C, T5 at -40°C to +70°C, T4 at -40°C to +80°C; Energy-limited (Non-incendive) when installed per Samson AG installation drawing EB8384-5 EN.

CLASS 2258 02 - PROCESS CONTROL EQUIPMENT - For Hazardous Locations

Ex nA II T6

Class I, Division 2, Groups A, B, C and D; Class II, Division 1, Groups E, F and G; Class III; Type 4 Enclosure

Model 3730-43 PROFIBUS PA Positioner, Temperature Code T6 at ambient of -40°C to +60°C, T5 at -40°C to +70°C, T4 at -40°C to +80°C. Refer to Samson AG installation drawing EB8384-5 EN for electrical ratings.

CONDITION OF ACCEPTABILITY

The Model 3730-43 PROFIBUS PA Positioner must be installed per SAMSON AG installation drawing EB8384-5 EN.

APPLICABLE REQUIREMENTS

CSA Std C22.2 No. 25-1966	-	Enclosures for Use in Class II, Groups E, F and G Hazardous Locations
CAN/CSA-C22.2 No. 94-M91	-	Special Purpose Enclosures
CSA Std C22.2 No. 142-M1987-	-	Process Control Equipment
CAN/CSA-C22.2 No.157-92	-	Intrinsically Safe and Non-Incendive Equipment for Use in Hazardous Locations
CSA Std C22.2 No. 213-M1987-	-	Non-Incendive Electrical Equipment for Use in Class I, Division 2 Hazardous Locations
CAN/CSA-E60079-0:02	-	Electrical Apparatus for Explosive Atmospheres, Part 0 – General Requirements
CAN/CSA-E60079-11:02	-	Electrical Apparatus for Explosive Atmospheres, Part 11 – Intrinsic Safety “i”
CAN/CSA-E60079-15:02	-	Electrical Apparatus for Explosive Atmospheres, Part 15 – Type of Protection “n”



Certificate: 1675787
Project: 70069173

Master Contract: 173246 (LR 54227)
Date Issued: 2017-05-24

MARKINGS

Marking nameplate shall bear the following information:

- CSA Monogram;
- Submitter Identification;
- Model number;
- Serial number or date code;
- Electrical Rating/Entity Parameters
- Hazardous Location Designation;
- Reference to installation drawing number.
- The caution: "Warning - Substitution of Components May Impair Intrinsic Safety";
- Temperature Code Rating
- Maximum ambient
- Year and Certificate Number followed by an indicator 'X'



Supplement to Certificate of Compliance

Certificate: 1675787

Master Contract: 173246 (LR 54227)

*The products listed, including the latest revision described below,
are eligible to be marked in accordance with the referenced Certificate.*

Product Certification History

Project	Date	Description
70069173	2017-05-24	Addition of new window in enclosure.
1675787	2017-04-12	Original Certification.

Installation Manual for apparatus certified by CSA for use in hazardous locations.
Communication is optionally either according to the FOUNDATION™ Fieldbus Specification or according to PROFIBUS PA in compliance FISCO-C concept

The **FISCO Concept** allows interconnection of intrinsically safe apparatus to associated apparatus not specifically examined in such combination. The criteria for interconnection is that the voltage (V_{max}) the current (I_{max}) and the power (P_{max}) which intrinsically safe apparatus can receive and remain intrinsically safe, considering faults, must be equal or greater than the voltage (V_{oc}) the current (I_{sc}) and the power (P_o) levels which can be delivered by the associated apparatus, considering faults and applicable factors. In addition, the maximum unprotected capacitance (C_i) and inductance (L_i) of each apparatus (other than the termination) connected to the fieldbus must be less than or equal to 5 nF and 10 μ H respectively.

In each segment only one active device, normally the associated apparatus, is allowed to provide the necessary energy for the fieldbus system. The allowed voltage (V_{oc}) of the associated apparatus is limited to the range of 14V DC. to 24V DC. All other equipment connected to the bus cable has to be passive, meaning that they are not allowed to provide energy to the system, except to a leakage current of 50mA for each connected device. Separately powered equipment needs a galvanic isolation to assure that the intrinsically safe fieldbus circuit remains passive.

The cable used to interconnect the devices need to have the parameters in the following range:

Loop resistance R' :	15 ... 150 Ohm/km
Inductance per unit length L' :	0,4 ... 1 mH/km
Capacitance per unit length C' :	80 ... 200 nF/km
$C' = C'_{line}/line + 0,5 C'_{line}/screen$, if both lines are floating or, $C' = C'_{line}/line + C'_{line}/screen$, if the screen is connected to one line	
Length of spur cable:	≤ 30 m
Length of trunk cable:	≤ 1 km

At each end of the trunk cable an approved infallible line termination with the following parameters is suitable:

$R = 90 \dots 100$ Ohm	$C = 0 \dots 2,2$ μ F
------------------------	---------------------------

One of the allowed terminations might already be integrated in the associated apparatus.

The number of passive devices connected to the bus segment is not limited due to I.S. reasons. If the above rules are respected, the inductance and capacitance of the cable will not impair the intrinsic safety of the installation.

Notes:

- Approved associated apparatus must be installed in accordance with manufacturer instructions
- Approved associated apparatus must meet the following requirements:
 $V_{oc} \leq V_{max}$, $I_{sc} \leq I_{max}$, $P_o \leq P_{max}$
- The maximum non-hazardous area voltage must not exceed 250 V.
- The installation must be in accordance with the Canadian Electrical Code Part 1.
- Each set of wires must be provided with grounded shield. The shield must extend as close to the terminal(s) as possible and it must be grounded shield at I. S. Barrier ground.
- Caution: Use only supply wires suitable for 5 °C above surrounding.
- Warning: Substitution of components may impair intrinsic safety. PE = I. S. Ground
- The polarity for connecting 11 and 12 is of no importance due to an internal rectifier.
- FISCO concept applies to fieldbus / circuit only.
- Entropy parameters apply to circuit 2, 3 and 4 and further required to meet the following conditions:
 $C_o \geq C_i + C_{cable}$; $L_o \geq L_i + L_{cable}$

Intrinsically safe if installed as specified in manufacturer's installation manual.

CSA- certified for hazardous locations

Type 4 Enclosure

Ex ia IIC T6

Class I, Division 1, Groups A, B, C and D; Class II, Division 1, Groups E, F + G; Class III.

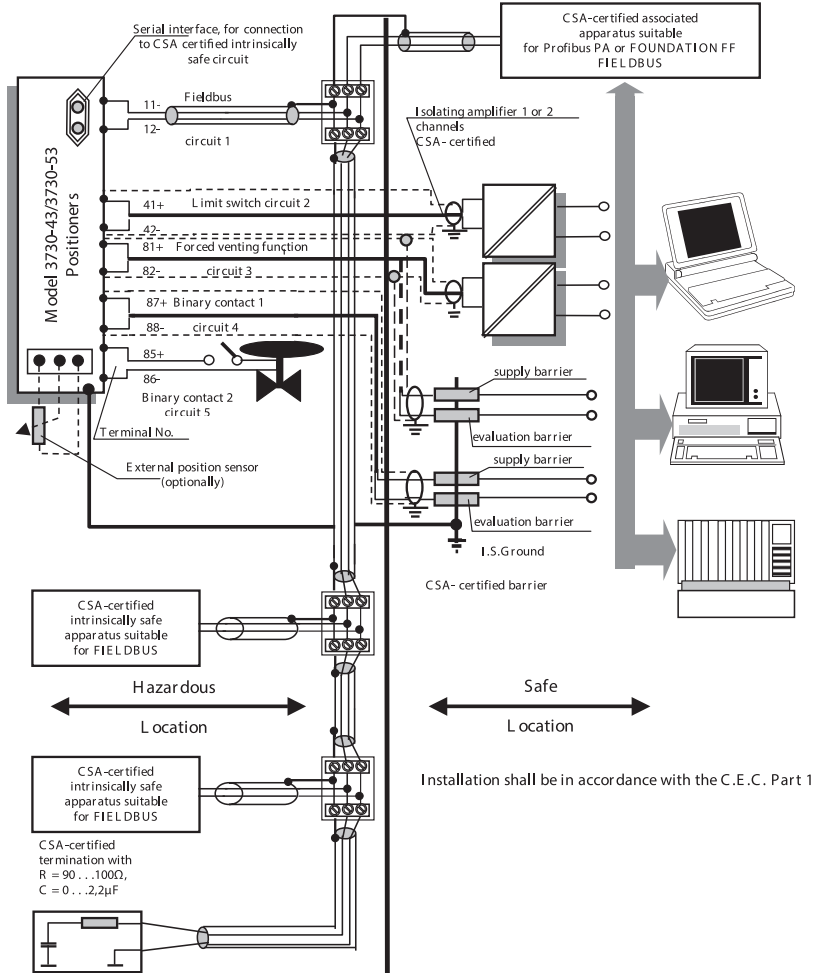

Table 1: Intrinsic Safety Parameters

	Fieldbus				Limitswitches inductive	Forced venting-function	Binary- input		Serial-Interface	
	Foundation		Profibus				1	2	Active	Passive
Circuit No.	1		1		2	3	4	5	6	6
Terminal No.	11 / 12 (IEC 1148-2)		11 / 12 (IEC 1148-2)		41 / 42	81 / 82	87 / 87	85 / 86	plug	
Groups	IIC	IIB	IIC	IIB	##	##	##	##	##	##
V _{max} [V]	24		17,5		16	28 30	28 30	###	###	16
U _o or V _{oc}	#####							5,88V	8,61V	###
I _{max} [mA]	360	380	380		25 52	115 100	115 100	###	###	25
I _o or I _{sc}	#####							1mA	55mA	###
P _{max} [W]	1,04	2,58	5,32		64mW 169mW	##	##	7,2 mW	250 mW	64 mW
C _i [nF]	2				60	5,3	0	###	###	0
C _o or C _a	#####							2μF	0,61μF	###
L _i [μH]	10				100	0	0	###	###	0
L _o or L _a	#####							10mH	9mH	###

Binary- input 1: For connection of an active signal circuit

Binary- input 2: For connection of an passive contact circuit directly on the control valve, e.g. passive pressure switch for leakage monitoring

Notes:

1. Entity parameters must meet the following requirements:

$$V_{oc} \leq V_{max}, I_{sc} \leq I_{max}, P_0 \leq P_{max}$$

$$C_o \text{ or } C_a \geq C_i + C_{cable} \text{ and } L_o \text{ or } L_a \geq L_i + L_{cable}$$

2. Install in accordance with the Canadian Electrical Code Part I
3. Cable entry M 20 x1,5 or metal conduit acc. to dwg. No. 1050-0540

* Circuit 3 can be connected to a CSA Certified zener barrier that is rated as follows:

- Supply channel (connect to Terminal 81): $V_{oc} \leq 28V$ max. and $R_{min} \geq 245 \Omega$
- Return channel (connect to Terminal 82): $\leq 28V$ max with diodes Return (zero current)

** Circuit 4 can be connected to a CSA Certified zener barrier that is rated as follows:

- Supply channel (connect to Terminal 87): $V_{oc} \leq 30V$ and $R_{min} \geq 300 \Omega$
- Return channel (connect to Terminal 88): $V_{oc} \leq 30V$ max with diodes Return (zero current)

Table 2: CSA – certified barrier parameters of circuit 4

Barrier	Supply barrier		Evaluation barrier	
	V _{oc}	R _{min}	V _{oc}	R _{min}
circuit 3	≤28V	≥245Ω	≤28V	Diode
circuit 4	≤30V	≥300Ω	≤30V	Diode

The correlation between temperature classification and permissible ambient temperature ranges is shown in the table 3 below:

Table 3:

Temperature class	Permissible ambient temperature range
T6	+60°C
T5	-40°C ≤ T _a ≤ +70°C
T4	+80°C

Table 4: Energy-Limited (Non- Incendive) Parameters

Terminal	Foundation Fieldbus or Profibus PA (Non incendive Equipment)								L limit- switches (inductive)	Forced venting function	Binary- Input 1	Maximum values for serial-interface and binary input 2 see table 1
	11 / 12 (IEC 1148-2)											
Groups	A, B and IIC				C, D and IIB				##	##	##	
U _i or V _{max} [VDC]	20V	24V	30V	32V	20V	24V	30V	32V	20V	28V 30V 32V	28V 30V 32V	
I _i or I _{max} [mA]	464	261	152	130	1,117 A	650	379	324	25mA 52mA	115mA 100mA 90mA	115mA 100mA 90mA	
P _i or P _{max} [W]	2,32	1,56	1,14	1,14	5,88	3,89	3,85	2,77	64mW 169mW	##	##	
C _i	2nF								30	5,3	0	
L _i	10μH								100	0	0	

CSA certified for hazardous locations:

Ex nA II T6 / Ex nL IIC T6
 Class I, Div. 2; Groups A, B, C, D; Class II, Div. 2 Groups E, F + G; Class III

Type 4 Enclosure

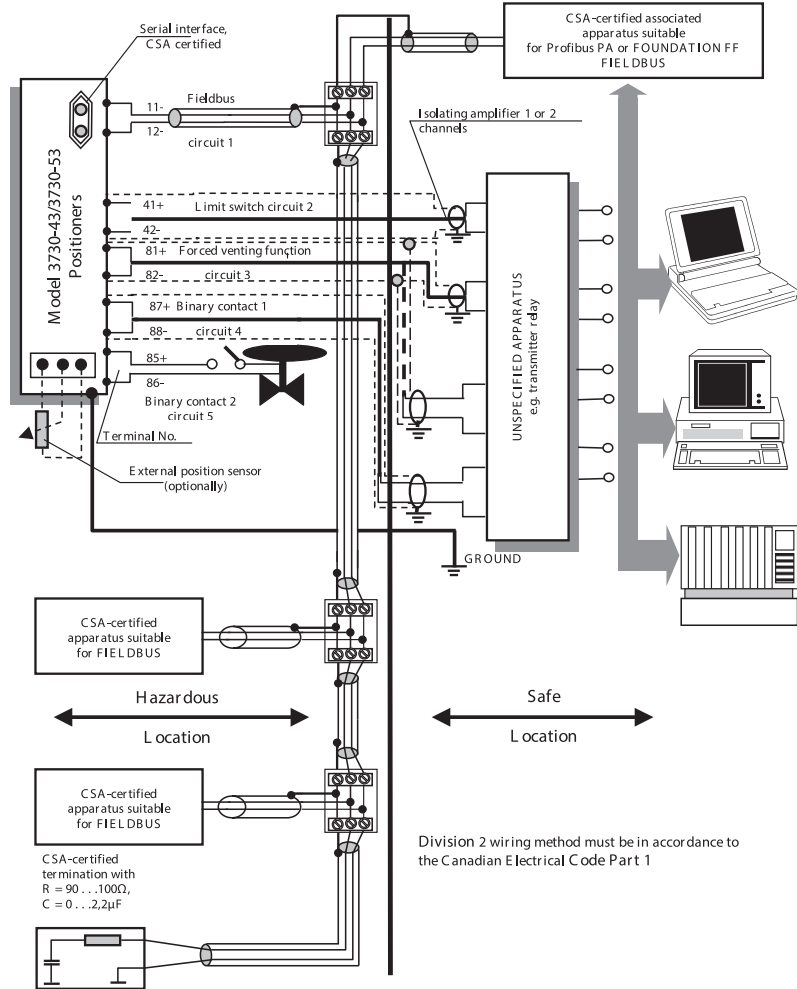

Installation drawing Control Relay KHA5-OTI/Ex2, KHA6-OTI/Ex1 or KHA6-OTI/Ex2 with Model SJ-b-N Proximity Sensors

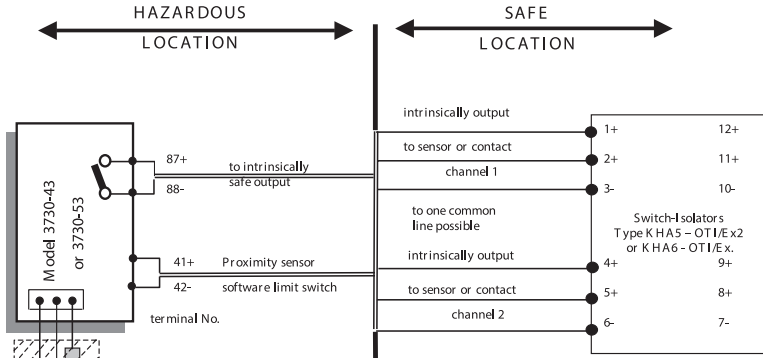

Model designation code Type K Hab - cF xde

- a= Supply Voltage type A or D
a=A, C, d=DC
- b= Supply Level
2=24V DC±15%; 5=120V AC +10%-15%;
6=230V AC+10%-15%;
- c= Output type RT A; RW 1; SS1; SS2; RS1;
SR; ST-or SOT
- d= Number of channels 1 or 2
- e= Power rail designation, P, 2S,P or GS,P
(includes Model KHD2-EB-PB Power Feed Module) or Blank

The total series inductance and shunt capacitance of shield wiring shall be restricted to the following maximum values

maximum capacitance of each inductive sensor 30nF
maximum inductance of each inductive sensor 100µH

System parameters

Control Relay Terminal No.	Groups	L [mH]	C [µF]	V _{0C} [V]	I _{SC} [mA]	V _{max} [V]	R _{min} [Ω]
1-3; 2-3 4-6; 5-6	A + B	192	2,66	↑	↑	↑	↑
	C + E	671	7,9	10,5	13	10,5	811
	D, F, G	1000	21,3	↓	↓	↓	↓

Division 2 wiring method shall be in accordance to the Canadian Electrical Code Part 1.

Installation Manual for apparatus approved by FM for use in hazardous locations. Communication is optionally either according to the FOUNDATION™ Fieldbus Specification or according to PROFIBUS PA in compliance FISCO-Concept

The FISCO Concept allows interconnection of intrinsically safe apparatus to associated apparatus not specifically examined in such combination. The criteria for interconnection is that the voltage (V_{max}/U_i) the current (I_{max}/I_i) and the power (P_i) which intrinsically safe apparatus can receive and remain intrinsically safe, considering faults, must be equal or greater than the voltage (V_{oc}/U_o) the current (I_{sc}/I_o) and the power (P_o) levels which can be delivered by the associated apparatus, considering faults and applicable factors. In addition, the maximum unprotected capacitance (C_i) and inductance (L_i) of each apparatus (other than the termination) connected to the fieldbus must be less than or equal to 5 nF and 10 µH respectively.

In each segment only one active device, normally the associated apparatus, is allowed to provide the necessary energy for the fieldbus system. The allowed voltage (V_{oc}/U_o) of the associated apparatus is limited to the range of 14V DC. to 24V DC. All other equipment connected to the bus cable has to be passive, meaning that they are not allowed to provide energy to the system, except to a leakage current of 50mA for each connected device. Separately powered equipment needs a galvanic isolation to assure that the intrinsically safe fieldbus circuit remains passive.

The cable used to interconnect the devices need to have the parameters in the following range:

Loop resistance R':	15 ... 150 Ohm/km
Inductance per unit length L':	0,4 ... 1 mH/km
Capacitance per unit length C':	80 ... 200 nF/km
C' = C' line/line + 0,5 C' line/screen, if both lines are floating or, C' = C' line/line + C' line/screen, if the screen is connected to one line	
Length of spur cable:	≤ 30 m
Length of trunk cable:	≤ 1 km

At each end of the trunk cable an approved infallible line termination with the following parameters is suitable:

$$R = 90 \dots 100 \text{ Ohm} \qquad C = 0 \dots 2,2 \text{ } \mu\text{F}$$

One of the allowed terminations might already be integrated in the associated apparatus.

The number of passive devices connected to the bus segment is not limited due to I.S. reasons. If the above rules are respected, the inductance and capacitance of the cable will not impair the intrinsic safety of the installation.

Notes:

- Approved associated apparatus must be installed in accordance with manufacturer instructions
- Approved associated apparatus must meet the following requirements:
 U_o or $V_{oc} \leq U_i$ or V_{max} , I_o or $I_{sc} \leq I_i$ or I_{max} , $P_o \leq P_i$ or P_{max}
- The maximum non-hazardous area voltage must not exceed 250 V.
- The installation must be in accordance with the National Electrical Code ANSI/NFPA 70 and ANSI/ISA RP 12.06.01
- Each set of wires must be provided with grounded shield. The shield must extend as close to the terminal(s) as possible and it must be grounded shield at I. S. Barrier ground.
- Caution: Use only supply wires suitable for 5 °C above surrounding.
- Warning: Substitution of components may impair intrinsic safety. PE = I. S. Ground
- The polarity for connecting 11 and 12 is of no importance due to an internal rectifier.
- FISCO concept applies to fieldbus / circuit only.
- Entity parameters apply to circuit 2, 3 and 4 and further required to meet the following conditions:
 $C_o \geq C_i + C_{cable}$; $L_o \geq L_i + L_{cable}$

Intrinsically safe if installed as specified in manufacturer's installation manual.

FM- approved for hazardous locations

Class I, Zone 0 AEx ia IIC T6:

Class I, II, III Div. 1, Groups A, B, C, D, E, F + G.

Field enclosure NEMA 4X

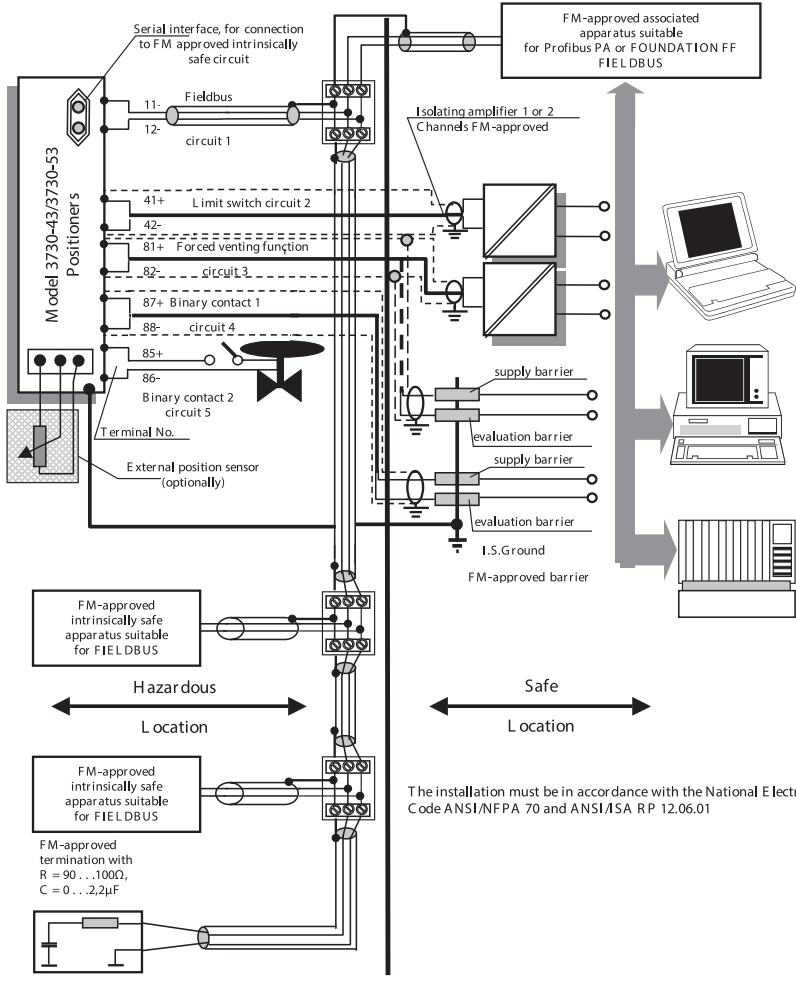

Table 1: Maximum values

	Fieldbus			Limit-switches inductive	Forced venting-function	Binary- input		Serial-I-Interface	
	Foundation		Profibus			1	2	active	passive
Circuit No.	1		1	2	3	4	5	6	6
Terminal No.	11 / 12		11 / 12	41 / 42	81 / 82	87 / 88	85 / 86	plug	
Groups	A, B IIC	C, D IIB	A, B, C, D IIC / IIB	##	##	##	##	##	##
U_i or V_{max} [V]	24		17,5	16	28	30	V_{0C} 5,88	V_{0C} 8,61	V_{max} 16
I_i or I_{max} [mA]	360	380	380	25	115	100	I_{SC} 1	I_{SC} 55	I_{max} 25
P_i or P_{max} [W]	1,04	2,58	5,32	64 mW	##	##	7,2 mW	250 mW	64 mW
C_i [nF]	5			60	5,3	0	2 μ F	0,61 μ F	0
L_i [μ H]	10			100	0	0	10mH	9mH	0

Binary- input 1: For connection of an active signal circuit

Binary- input 2: For connection of an passive contact circuit directly on the control valve, e.g. passive pressure switch for leakage monitoring

Notes:

- Entity parameters must meet the following requirements:

$$U_0 \leq U_i \text{ or } V_{max}, I_0 \leq I_i \text{ or } I_{max}, P_0 \leq P_i \text{ or } P_{max}$$

$$C_0 \text{ or } C_a \geq C_i + C_{cable} \text{ and } L_0 \text{ or } L_a \geq L_i + L_{cable}$$

- The installation must be in accordance with the National Electrical Code ANSI/NFPA 70 and ANSI/ISA RP 12.06.01
- Cable entry M 20 x1,5 or metal conduit acc. to dwg. No. 1050-0540

Table 2: FM – approved barrier parameters of circuit 4

Barrier	Supply barrier				Evaluation barrier	
	V _{OC}	R _{min}	I _{OC}	P _{max}	V _{OC}	R _{min}
circuit 3	≤28V	≥245Ω	≤115mA	##	≤28V	Diode
circuit 4	≤30V	≥300Ω	≤100mA	##	≤30V	Diode

The correlation between temperature classification and permissible ambient temperature ranges is shown in the table 3 below:

Table 3:

Temperature class	Permissible ambient temperature range
T6	+60°C
T5	-40°C ≤ T _a ≤ +70°C
T4	+80°C

Table 4:

Terminal	Foundation Fieldbus or Profibus PA (Non incendive Field wiring)								L limit- switches (inductive)	Forced venting function	Binary- Input 1	Maximum values for serial-interface and binary input 2 see table 1
	Groups	A, B and IIC				C, D and IIB						
U _i or V _{max} [VDC]	20V	24V	30V	32V	20V	24V	30V	32V	20V	30V	30V	
I _i or I _{max} [mA]	464	261	152	130	1,117 A	650	379	324	25mA	100mA	100mA	
P _i or P _{max} [W]	2,32	1,56	1,14	1,14	5,88	3,89	3,85	2,77	64mW	##	##	
C _i	5nF								60	5,3	0	
L _i	10μH								100	0	0	

FM approved for hazardous locations:
 Ex nA II T6; Ex nL IIC T6 Zone 2.
 Class I, II, Div. 2 Groups A, B, C, D, E+F.

Field enclosure NEMA 4X

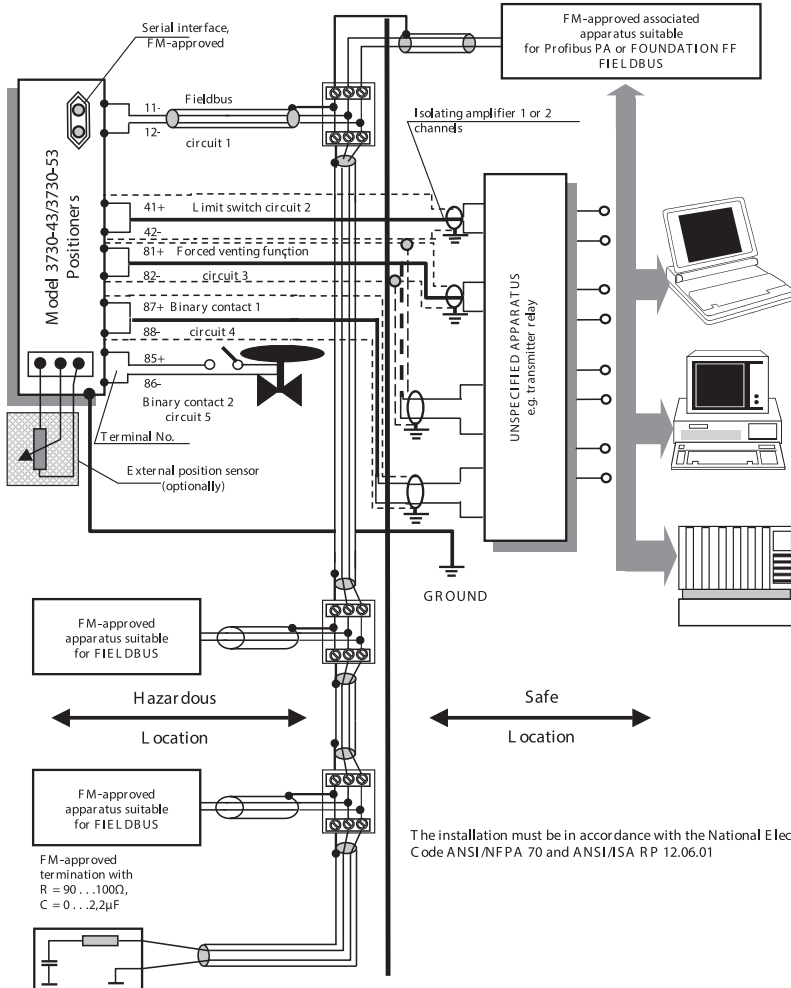

Installation drawing Control Relay KHA5-OTI/Ex2, KHA6-OTI/Ex1 or KHA6-OTI/Ex2 with Model SJ-b-N Proximity Sensor

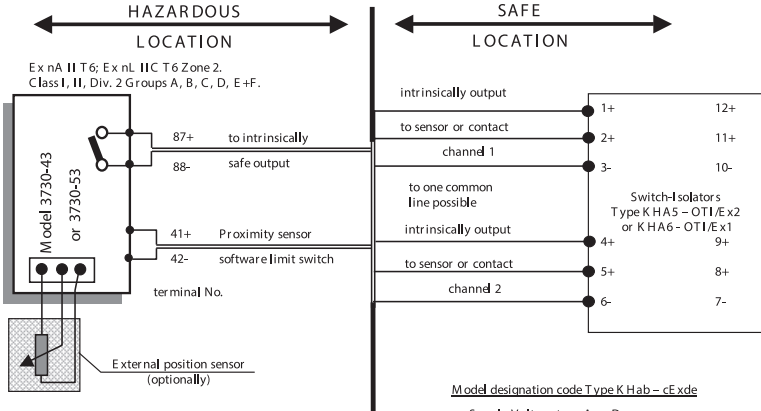

Model designation code Type KHab - cExD

- a= Supply Voltage type A or D
a=AC, d=DC
- b= Supply Level
2=24V DC±15%; 5=120V AC +10%-15%;
6=230V AC +10%-15%;
- c= Output type RTA/; RW1/; SS1/; SS2/; RS1/
SR/; ST- or SOT
- d= Number of channels 1 or 2
- e= Power rail designation, P, 2S.P or G.S.P
(includes Model KHD2-EB-PB Power Feed Module) or Blank

maximum capacitance of each inductive sensor 30nF
maximum inductance of each inductive sensor 100µH

Each pair of I.S. wires must be protected by a shield that is grounded at the I.S. Ground. The shield must be extend as close to the terminals as possible installation shall be in accordance with the National Electrical Code ANSI/NFPA 70 and ANSI/ISA RP 12.06.01.

The total series inductance and shunt capacitance of shield wiring shall be restricted to the following maximum values

System parameters

Control Relay Terminal No.	Groups	L [mH]	C [µF]	V _{OC} [V]	I _{SC} [mA]	V _{max} [V]	R _{min} [Ω]
1-3; 2-3 4-6; 5-6	A + B	192	2,66	↑	↑	10,5	811
	C + E	671	7,9	10,5	13	↓	↓
	D, F, G	1000	21,3	↓	↓	↓	↓

ЕВРАЗИЙСКИЙ ЭКОНОМИЧЕСКИЙ СОЮЗ

СЕРТИФИКАТ СООТВЕТСТВИЯ



№ ЕАЭС RU C-DE.HA65.B.00510/20

Серия **RU** № **0215083**

ОРГАН ПО СЕРТИФИКАЦИИ **ПРОДУКЦИИ** Общества с ограниченной ответственностью «ТехБезопасность» (ООО «ТехБезопасность») Адрес места нахождения юридического лица: 127486, Россия, город Москва, улица Дегунинская, дом 1, корпус 2, этаж 3, помещение 1, комната 19. Адрес мест осуществления деятельности в области аккредитации: 105066, Россия, город Москва, улица Никитя Красновосельская, дом 35, строение 64, комната 22 "а"; 301668, Россия, Тульская область, город Новомосковский, улица Орджоникидзе, дом 8 пристроенное нежилое здание – пристройка к цеху №3, 3 этаж, помещение 4 и помещение 10. Номер аттестата аккредитации (регистрационный номер) RA.RU.11HA65. Дата вступления в реестр сведений об аккредитованном лице - 10.08.2018. Телефон: +74952081646, адрес электронной почты: tech-bez@inbox.ru.

ЗАЯВИТЕЛЬ

Общество с ограниченной ответственностью «Самсон Контролс». Основной государственный регистрационный номер 1037700041026. Место нахождения (адрес юридического лица) и адрес места осуществления деятельности: 109544, Россия, Москва, бульвар Энтузиастов, дом 2, этаж 5, комната 11. Телефон: +74957774545, адрес электронной почты: samson@samson.ru

ИЗГОТОВИТЕЛЬ

SAMSON AG Mess- und Regeltechnik
Место нахождения (адрес юридического лица) и адрес места осуществления деятельности по изготовлению продукции: Weismullerstrasse 3, 60314 Frankfurt am Main, Германия.

ПРОДУКЦИЯ

Электронневматические позиционеры типов 3730-21, 3730-41, 3730-51, 3767-1, 3725-113, 3731-321, 3731-521, 3731-324, 3731-524, 4763-1. Маркировки взрывозащиты и защиты от воспламенения горючей пыли и иные сведения о продукции, обеспечивающие ее идентификацию, приведены на листах 1, 2, 3, 4, 5, 6 приложения (бланки №№: 0725082, 0725083, 0725084, 0725085, 0725086, 0725087).
Серийный выпуск.

КОД ТН ВЭД ЕАЭС 9032 81 000 0

СООТВЕТСТВУЕТ ТРЕБОВАНИЯМ Технического регламента Таможенного союза «О безопасности оборудования для работы во взрывоопасных средах» (ТР ТС 012/2011)

СЕРТИФИКАТ СООТВЕТСТВИЯ ВЫДАН НА ОСНОВАНИИ

Протокола испытаний № 0730-НИ-01 от 18.03.2020 года Испытательной лаборатории взрывозащитного оборудования Общества с ограниченной ответственностью "ТЕХБЕЗОПАСНОСТЬ", аттестат аккредитации RA.RU.21HB54 от 26.03.2018. Акта анализа состояния производства № 0730-АСП от 11.02.2020. Технической документации изготовителя согласно листу 6 приложения (бланк № 0725087). Схема сертификации 1с.

ДОПОЛНИТЕЛЬНАЯ ИНФОРМАЦИЯ

Стандарты и иные нормативные документы, применяемые при подтверждении соответствия, приведены на листе 7 приложения (бланк № 0725088). Условия хранения: от минус 60 °С до плюс 60 °С. Срок хранения – 24 месяца. Срок службы (годности) – 15 лет.

СРОК ДЕЙСТВИЯ С 19.03.2020 **ПО** 18.03.2025
ВКЛЮЧИТЕЛЬНО

Руководитель (уполномоченное лицо) органа по сертификации

Эксперт (эксперт-аудитор) (эксперты (эксперты-аудиторы))

ПО

18.03.2025

(подпись)

(подпись)



Пенюмарен Михаил Валерьевич (Ф.И.О.)

М.П.

(Ф.И.О.)

Шмелев Антон Андреевич

(Ф.И.О.)

ПРИЛОЖЕНИЕ

К СЕРТИФИКАТУ СООТВЕТСТВИЯ № ЕАЭС RU C-DE.HA.65.B.00510/20

Серия **RU** № **0725083**

2.13. При установке и техническом обслуживании позиционеров типа 3725-113 необходимо принимать меры для обеспечения безопасности от статических зарядов, которые могут образоваться на поверхности крышки, согласно инструкции. Прибор должен быть оснащен табличкой с предупреждающей надписью.

3. Спецификация и идентификация продукции

Маркировка взрывозащиты и защиты от воспламенения горючей пыли в зависимости от типов позиционеров приведена в таблице 1.

Таблица 1

Наименование взрывозащищенного электрооборудования	Маркировка взрывозащиты	Маркировка защиты от воспламенения горючей пыли
Электропневматические позиционеры типов 3730-21, 3730-41, 3730-51	1Ex ia IIC T6/T5/T4 Gb X	Ex tb IIIC T80°C Db X
Электропневматические позиционеры типов 3767-1, 4763-1	1Ex ia IIC T6/T5/T4 Gb X	-
Электропневматические позиционеры типа 3725-113	1Ex ia IIC T4 Gb X	-
Электропневматические позиционеры типа 3731-321	1Ex d IIC T6/T5/T4 Gb X 1Ex d e IIC T6/T5/T4 Gb X	Ex tb IIIC T80°C Db X
Электропневматические позиционеры типа 3731-521	1Ex d IIC T6/T5/T4 Gb X 1Ex d e IIC T6/T5/T4 Gb X 1Ex d [ia Ga] IIC T6/T5/T4 Gb X 1Ex ia IIC T6/T5/T4 Gb X	Ex tb IIIC T80°C Db X
Электропневматические позиционеры типов 3731-324, 3731-524	1Ex d IIC T6/T5/T4 Gb X	Ex tb IIIC T80°C Db X

Подробное разъяснение к спецификационным кодам электропневматических позиционеров приводится в технической документации изготовителя.

4. Основные технические данные

4.1. Позиционеры типа 3730-21

- 4.1.1. Степень защиты оболочки по ГОСТ 14254-2015, не ниже IP66
- 4.1.2. Допустимые диапазоны температур окружающей среды для температурного класса, °C
 - T4 минус 45...+80
 - T5 минус 45...+70
 - T6 минус 45...+60
- 4.1.3. Параметры искробезопасных цепей

Таблица 2

Цепь	U _i , В	I _i , мА	P _i , Вт	C _i , нФ	L _i , мкГн
Контакты 11/12	28	115	1	5,3	≈0
Контакты 31/32 при подключении:					
датчика фактического положения	28	115	1	5,3	≈0
датчика двоичного сигнала	28	115	-	56,3	≈0
сенсора вибрации (шума)	28	115	-	5,3	≈0
Контакты 41/42 (индуктивный концевой датчик)	16	52 или 25	0,169 или 0,064	30	100
Контакты 41/42 и 51/52 (программное обеспечение)	20	60	0,25	5,3	≈0
Контакты 81/82 (магнитный клапан)	28	115	-	5,3	≈0
Контакты 83/84 (индикация о неполадках)	20	60	0,25	5,3	≈0

Руководитель (уполномоченное лицо) органа по сертификации

Эксперт (эксперт-аудитор) (эксперты (эксперты-аудиторы))

Паномырен Михаил Валерьевич (Ф.И.О.)

Шмелев Антон Андреевич (Ф.И.О.)



ПРИЛОЖЕНИЕ

К СЕРТИФИКАТУ СООТВЕТСТВИЯ № ЕАЭС RU C-DE.НА65.B.00510/20

Серия RU № 0725084

Последовательный интерфейс (программирование сокетов BU)					
Входные искробезопасные параметры					
U _н , В	I _н , мА	P _н , Вт	C _н , нФ	L _н , мГн	
20	60	0,25	=0	=0	
Выходные искробезопасные параметры					
U _в , В	I _в , мА	P _в , мВт	C _в , мкФ	L _в , мГн	
6,51	57,5	94	22	10	
Внешний датчик положения					
Входные искробезопасные параметры					
U _н , В	I _н , мА	P _н , Вт	C _н , нФ	L _н , мГн	
-	-	-	730	370	
Выходные искробезопасные параметры					
U _в , В	I _в , мА	P _в , мВт	C _в , мкФ	L _в , мГн	
6,51	56	91	11,2	11,6	

4.1.4. Допустимые диапазоны температур окружающей среды-позиционеров с индуктивными концевыми датчиками для температурного класса, °С

Ток - 52 мА, мощность - 169 мВт

T4 минус 45...+75

T5 минус 45...+60

T6 минус 45...+45

Ток - 25 мА, мощность - 64 мВт

T4 минус 45...+80

T5 минус 45...+80

T6 минус 45...+60

4.2. Позиционеры типов 3730-41, 3730-51

4.2.1. Степень защиты оболочки по ГОСТ 14254-2015, не ниже IP66

4.2.2. Допустимые диапазоны температур окружающей среды для температурного класса, °С

T4 минус 55...+80

T5 минус 55...+80

T6 минус 55...+60

4.2.3. Параметры искробезопасных цепей

Таблица 3

Цепь	U _н , В	I _н , мА	P _н , Вт	C _н , нФ	L _н , мкГн
Контакты 11/12: Блок питания FISCO	17,5	380	5,32	5	10
Блок питания FIELDBUS	24	360 (ИС) или 380 (ИВ)	1,04 (ИС) или 2,58 (ИВ)		
Контакты 87/88 (бинарный вход 1)	30	100	-	=0	=0
Контакты 41/42 (индуктивный концевой датчик)	16	52 или 25	0,169 или 0,064	60	100
Контакты 81/82 (клапан принудительного сброса)	28	115	-	5,3	=0

Последовательный интерфейс (программирование сокетов BU)					
Входные искробезопасные параметры					
U _н , В	I _н , мА	P _н , Вт	C _н , нФ	L _н , мГн	
16	25	0,064	=0	=0	

Руководитель (уполномоченное лицо) органа по сертификации

(подпись)

Эксперт (эксперт-аудитор) (эксперты (эксперты-аудиторы))

(подпись)



Панюмарев Михаил Валерьевич (И.О.)

М.П.

Шмелев Антон Андреевич (И.О.)

ПРИЛОЖЕНИЕ

К СЕРТИФИКАТУ СООТВЕТСТВИЯ № ЕАЭС RU C-DE.НА65.В.00510/20

Серия **RU** № **0725085**

Выходные искробезопасные параметры					
$U_o, В$	$I_o, мА$	$P_o, мВт$	$C_o, мкФ$	$L_o, мГн$	
8,61	55	250	0,61 (ПС) 4 (ПВ)	9	
Внешний датчик положения					
Входные искробезопасные параметры					
$U_i, В$	$I_i, мА$	$P_i, Вт$	$C_i, нФ$	$L_i, мГн$	
-	-	-	730	370	
Выходные искробезопасные параметры					
$U_o, В$	$I_o, мА$	$P_o, мВт$	$C_o, мкФ$	$L_o, мГн$	
8,61	55	250	0,61 (ПС) 4 (ПВ)	9	
Контакты 85/86 (биполярный вход 2)	5,88	1	2 (ПС) 16 (ПВ)	10 (ПС) 1000 (ПВ)	

4.2.4. Допустимые диапазоны температур окружающей среды позиционеров с индуктивными концевыми датчиками для температурного класса, °С

- Ток – 52 мА, мощность – 169 мВт
- T4 минус 55...+75
- T5 минус 55...+60
- T6 минус 55...+45
- Ток – 25 мА, мощность – 64 мВт
- T4 минус 55...+80
- T5 минус 55...+80
- T6 минус 55...+60

4.3. Позиционеры типа 3767-1

4.3.1. Степень защиты оболочки по ГОСТ 14254-2015, не ниже Пр66

4.3.2. Допустимые диапазоны температур окружающей среды для температурного класса, °С

- T4 минус 45...+80
- T5 минус 45...+70
- T6 минус 45...+60

4.3.3. Параметры искробезопасных цепей

Таблица 4

Цепь	$U_i, В$	$I_i, мА$	$P_i, Вт$	$C_i, нФ$	$L_i, мГн$
Контакты 11/12	28	100	0,7	≈0	≈0
	25	85			
	25	120	0,7	≈0	≈0
Контакты 41/42 и 51/52 (индуктивный концевой датчик)	16	52 или 25	0,169 или 0,064	30	100
Контакты 31/32 (датчик фактического положения)	28	115	1	5,3	≈0

4.3.4. Допустимые диапазоны температур окружающей среды позиционеров с индуктивными концевыми датчиками для температурного класса, °С

- Ток – 52 мА, мощность – 169 мВт
- T4 минус 45...+75
- T5 минус 45...+60
- T6 минус 45...+45
- Ток – 25 мА, мощность – 64 мВт
- T4 минус 45...+80
- T5 минус 45...+80
- T6 минус 45...+60

Руководитель (уполномоченное лицо) органа по сертификации

(подпись)

Эксперт (эксперт-аудитор) (эксперты (эксперты-аудиторы))

(подпись)



Поповичев Михаил Валерьевич

(ф.и.о.)

М.П.

Шмелев Антон Андреевич

(ф.и.о.)

ПРИЛОЖЕНИЕ

К СЕРТИФИКАТУ СООТВЕТСТВИЯ № ЕАЭС RU C-DE.HA65.B.00510/20

Серия **RU** № **0725086**

4.3.5. Параметры позиционеров типа 3767-1 электромагнитными клапанами

Таблица 5

Разъемы	контакты (81/82)				
	25 В	27 В	28 В	30 В	32 В
U _i ≤	150 мА	125 мА	115 мА	100 мА	90 мА
I _i ≤	пренебрежимо малы				
L _i					
C _i					
Допустимые диапазоны температур окружающей среды для температурного класса:					
Температурный класс	Диапазон температур окружающей среды, °С				
T6	-45 ≤ T _a ≤ +60				
T5	-45 ≤ T _a ≤ +70				
T4	-45 ≤ T _a ≤ +80				
Номинальное напряжение, U _н , В					
	6	12		24	
Примечание: максимально допустимая мощность рассеяния P _и в исполнении 6 В соответствует 250 мВт.					

4.4. Позиционеры типа 3725-113

4.4.1. Степень защиты оболочки по ГОСТ 14254-2015, не ниже IP66

4.4.2. Параметры искробезопасных цепей

Таблица 6

Цепь	U _i , В	I _i , мА	P _i , Вт	C _и , нФ	L _и , мкГн
Контакты 11/12	28	115	1	8,3	≈0
Контакты 41/42 и 51/52 (программное обеспечение)	20	60	0,25	≈0	≈0

4.4.3. Температура окружающей среды, °С минус 25...+80

4.5. Позиционеры типов 3731-321, 3731-521, 3731-324, 3731-524

4.5.1. Степень защиты оболочки по ГОСТ 14254-2015, не ниже IP66

4.5.2. Напряжение питания постоянного тока исполнений Exd/Exde, В 10...35

4.5.3. Максимальная рассеиваемая мощность исполнений Exd/Exde, Вт 7.5

4.5.4. Параметры искробезопасных цепей исполнений Exia

Таблица 7

Цепь	U _i , В	I _i , мА	P _i , Вт	C _и , нФ	L _и , мкГн
Блок питания FIELDBUS	24	380	1,04 (ПС) или 2,58 (ПВ)	5	10
Контакты А, В (клапан принудительного сброса)	28 или 32	115 или 87,6	-	7,26	≈0
Контакты А, В, С (бинарный вход)	25	150	-	110	≈0

4.5.5. Допустимые диапазоны температур окружающей среды для температурного класса, °С

типы 3731-321, 3731-521

T4 минус 40...+80

T5 минус 40...+70

T6 минус 40...+60

типы 3731-324, 3731-524

T4 минус 60...+80

T5 минус 60...+70

T6 минус 60...+60

4.6. Позиционеры типа 4763-1

4.6.1. Степень защиты оболочки по ГОСТ 14254-2015, не ниже IP66

Руководитель (уполномоченное лицо) органа по сертификации

М.П.
(подпись)



Попомарев Михаил Валерьевич

(ф.и.о.)

М.П.

Щмелев Антон Андреевич

(ф.и.о.)

Эксперт (эксперт-аудитор) (эксперты (эксперты-аудиторы))

Щмелев
(подпись)

ПРИЛОЖЕНИЕ

К СЕРТИФИКАТУ СООТВЕТСТВИЯ № ЕАЭС RU C-DE.НА65.В.00510/20

Серия **RU** № **0725087**

4.6.2. Параметры искробезопасных цепей

Таблица 8

Цепь	U _i , В	I _i , мА	P _i , Вт	C _i , нФ	L _i , мкГн
Контакты 11/12	28	100 или 85	0,7	=0	≈0
	25	120	0,7	≈0	≈0

4.6.3. Максимальные параметры тока короткого замыкания позиционеров с электропневматическими модулями типа 6109-1 для соответствующих диапазонов температур окружающей среды и температурных классов

Таблица 9

Температурный класс	Температура окружающей среды, °С	Максимальный ток короткого замыкания I _к , мА
T6	-45 до +60	85
T5	-45 до +70	
T4	-45 до +80	
T5	-45 до +70	100
T4	-45 до +80	

4.6.4. Максимальные параметры тока короткого замыкания позиционеров с электропневматическими модулями типа 6112-2 для соответствующих диапазонов температур окружающей среды и температурных классов

Таблица 10

Температурный класс	Температура окружающей среды, °С	Максимальный ток короткого замыкания I _к , мА
T6	-45 до +60	85
T5	-45 до +70	100
T4	-45 до +80	120

5. Техническая документация изготовителя

- 5.1. Руководства по эксплуатации на электропневматические позиционеры типа 3730-21 № ЕВ 8384-2 (март 2018), типа 3725-113 № 8394 (октябрь 2018), типов 3730-41 № ЕВ 8384-4 (август 2019) и 3730-51 № ЕВ 8384-5 (декабрь 2018), типов 3731-321 и 3731-324 № ЕВ 8387-3 (июль 2018), типов 3731-521 и 3731-524 № ЕВ 8387-5 (ноябрь 2018), типа 3767-1 № ЕВ 8355-2 (октябрь 2018), типа 4763-1 № ЕВ 8359-2 (ноябрь 2018)
- 5.2. Паспорта №№ 4218-373021-003-2019.П.С., 4218-3725-001-2019.П.С., 4218-3725-002-2019.П.С., 4218-373051-001-2019.П.С., 4218-373051-002-2019.П.С., 4218-3731321-003-2019.П.С., 4218-3731321-004-2019.П.С., 4218-3731324-001-2019.П.С., 4218-3731324-002-2019.П.С., 4218-3767-001-2019.П.С., 4218-3767-002-2019.П.С., 4218-4763-001-2019.П.С., 4218-4763-002-2019.П.С.
- 5.3. Чертежи №№ 1050-0737 S, 1050-0738, 1050-0739 S, 1050-0807 S, 1050-0808 S, 1050-0815 S, 1050-0903 S, 1050-0961 S, 1050-0904 S, 1050-0962 S, 1000103085, 1000104673, 1000104674, 1050-0728 T, 1000103347, 1000104601, 1050-1077, 1050-1123-SWD, 1000104509, 1000104510, 1000103086, 1000103087, 1000104152, 1000104380, 1050-1610-SWD, 1050-0728 T, 1050-0738, 1050-0739 S, 1050-0740 S, 1050-0741 S, 1050-0858-SWD, 1050-0859 S, 1050-0860 S, 1050-0903 S, 1050-0904 S, 1050-0961 S, 1050-0962 S, 1050-1611-SWD, 1050-1443-SWD, 1050-1444-SWD, 1050-1617-SWD, 1000103421, 1000103424, 1000103423, 1000103426, 1000104396, 1050-0832-SWD, 1050-0833-SWD, 1050-0834-SWD, 1050-0835-SWD, 1050-1728-SWD, 1050-1729-SWD, 1050-1752-SWD, 1000104658, 1000103429, 1000103431, 1000104772, 1050-0698 T, 1050-0699 T, 1050-0700 S, 1050-0701 S.

При внесении изготовителем или организацией, проводящей эксплуатацию оборудования, в конструкцию и (или) техническую документацию, подтверждающую соответствие оборудования и (или) Ех-компонента требованиям ТР ТС 012/2011, изменений, влияющих на показатели взрывобезопасности оборудования, изготовитель или организация, проводящая эксплуатацию оборудования, должны предоставить в орган по сертификации описание изменений, техническую документацию (чертежи средств обеспечения нормативности) с внесенными изменениями и образцы для проведения дополнительных испытаний, если органы по сертификации посчитают необходимым проведение только экспертных технической документации с внесенными изменениями для принятия решения о соответствии оборудования и (или) Ех-компонента ТР ТС 012/2011 с внесенными изменениями.

Руководитель (уполномоченное лицо) органа по сертификации

Эксперт (эксперт-аудитор) (эксперты (эксперты-аудиторы))

Пономарев Михаил Валерьевич (Ф.И.О.)

М.П.

Шмелев Антон Андреевич (Ф.И.О.)

ПРИЛОЖЕНИЕ

К СЕРТИФИКАТУ СООТВЕТСТВИЯ № ЕАЭС RU C-DE.НА65.В.00510/20

Серия **RU** № **0725088**

Стандарты и иные нормативные документы, применяемые при подтверждении соответствия

Обозначение стандарта, нормативного документа	Наименование стандарта, нормативного документа	Раздел (пункт, подпункт) стандарта, нормативного документа
ГОСТ 31610.0-2014 (IEC 60079-0:2011)	Взрывоопасные среды. Часть 0. Оборудование. Общие требования.	Стандарт в целом
ГОСТ IEC 60079-1-2011	Взрывоопасные среды. Часть 1. Оборудование с видом взрывозащиты «взрывонепроницаемые оболочки "d"».	Стандарт в целом
ГОСТ Р МЭК 60079-7-2012	Взрывоопасные среды. Часть 7. Оборудование. Повышенная защита вида «с».	Стандарт в целом
ГОСТ 31610.11-2014 (IEC 60079-11:2011)	Взрывоопасные среды. Часть 11. Оборудование с видом взрывозащиты «искробезопасная электрическая цепь «i»».	Стандарт в целом
ГОСТ Р МЭК 60079-31-2010	Взрывоопасные среды. Часть 31. Оборудование с видом взрывозащиты от воспламенения пыли «с».	Стандарт в целом

Руководитель (уполномоченное
лицо) органа по сертификации

М.П.
(подпись)

Эксперт (эксперт-аудитор)
(эксперты (эксперты-аудиторы))

М.П.
(подпись)



Попомарев Михаил Валерьевич
(ф.и.о.)

М.П.

Шмельев Антон Андреевич
(ф.и.о.)

16 Annex A (configuration instructions)

16.1 Parameters and functions

Code no.	Parameter – Readings/values [default setting]	Description
----------	---	-------------

Note: Codes marked with an asterisk (*) must be enabled with Code 3 prior to configuration.

0	Operating mode [MAN] Manual mode AUTO Automatic mode SAFE Fail-safe position ESC Cancel	Switchover from automatic to manual mode is bumpless. In fail-safe position, the S icon is displayed. In MAN and AUTO mode, the system deviation is represented by the bar graph elements. The reading indicates the valve position or angle of rotation in % when the positioner is initialized. If the positioner is not initialized, the position of the lever in relation to the longitudinal axis is displayed in degrees (°).																											
1	Manual w [0] to 100 % of the nominal range	Adjust the manual set point with the rotary pushbutton. The current travel/angle is displayed in % when the positioner is initialized. If the positioner is not initialized, the position of the lever in relation to the longitudinal axis is indicated in degrees (°). Note: can only be selected when Code 0 = MAN																											
2	Reading direction 1234, ↻, ESC	The reading direction of the display is turned by 180°.																											
3	Enable configuration [No], YES, ESC	Enables changing of data (automatically deactivated when the rotary pushbutton has not been operated for 120 s). PA blinks on the display when the on-site operation is locked over PROFIBUS-PA communication. Codes marked with an asterisk (*) can only be read and not overwritten. Similarly, codes can only read over the SSP interface.																											
4*	Pin position [No], 17, 25, 35, 50, 70, 100, 200 mm, 90° with rotary actuators, ESC Note: If you select a pin position in Code 4 that is too small, the positioner switches to SAFE mode for reasons of safety.	Follower pin must be mounted in the proper position depending on the valve travel/opening angle. Pin position must be entered for nominal (NOM) or substitute (SUB) initialization.																											
		<table border="1"> <thead> <tr> <th>Pin position Code 4</th> <th>Standard Code 5</th> <th>Adjustment range Code 5</th> </tr> </thead> <tbody> <tr> <td>17</td> <td>7.5</td> <td>3.6 to 17.7</td> </tr> <tr> <td>25</td> <td>7.5</td> <td>5.0 to 25.0</td> </tr> <tr> <td>35</td> <td>15.0</td> <td>7.0 to 35.4</td> </tr> <tr> <td>50</td> <td>30.0</td> <td>10.0 to 50.0</td> </tr> <tr> <td>70</td> <td>40.0</td> <td>14.0 to 70.7</td> </tr> <tr> <td>100</td> <td>60.0</td> <td>20.0 to 100.0</td> </tr> <tr> <td>200</td> <td>120.0</td> <td>40.0 to 200.0</td> </tr> <tr> <td>90°</td> <td>90.0</td> <td>24.0 to 100.0</td> </tr> </tbody> </table>	Pin position Code 4	Standard Code 5	Adjustment range Code 5	17	7.5	3.6 to 17.7	25	7.5	5.0 to 25.0	35	15.0	7.0 to 35.4	50	30.0	10.0 to 50.0	70	40.0	14.0 to 70.7	100	60.0	20.0 to 100.0	200	120.0	40.0 to 200.0	90°	90.0	24.0 to 100.0
Pin position Code 4	Standard Code 5	Adjustment range Code 5																											
17	7.5	3.6 to 17.7																											
25	7.5	5.0 to 25.0																											
35	15.0	7.0 to 35.4																											
50	30.0	10.0 to 50.0																											
70	40.0	14.0 to 70.7																											
100	60.0	20.0 to 100.0																											
200	120.0	40.0 to 200.0																											
90°	90.0	24.0 to 100.0																											

Annex A (configuration instructions)

Code no.	Parameter – Readings/values [default setting]	Description
5*	Nominal range mm or angle °, ESC	Nominal valve travel or opening angle must be entered for nominal (NOM) or substitute (Sub) initialization. The possible adjustment range depends on the pin position from the table for Code 4. Code 5 is generally locked until Code 4 is set to No, i.e. after a pin position has been entered, Code 5 can be configured. Indicates maximum travel/angle reached during initialization after initialization has been successfully completed.
6*	Init mode [MAX] Maximum range NOM Nominal range MAN Manual setting SUb Emergency mode ZP Zero calibration ESC Cancel	Select the initialization mode MAX: Travel/angle of the closure member from the CLOSED position to the opposite stop in the actuator. NOM: Travel/angle of the closure member measured from the CLOSED position to the indicated OPEN position. MAN: Manually selected range SUB: Substitute calibration (without initialization)
7*	w/x [↗↗] Increasing/increasing ↗↘ Increasing/decreasing ESC	Direction of action of the set point w in relation to the travel/angle x Automatic adaptation: AIR TO On completing initialization, the direction of action OPEN: remains increasing/increasing (↗↗). A globe valve opens as the set point increases. AIR TO On completing initialization, the direction of action CLOSE: changes to increasing/decreasing (↗↘). A globe valve closes as the set point increases.
8*	Travel/angle range start (lower x-range value) [0.0] to 80.0 % of the nominal range, ESC Note: Specified in mm or angle ° provided Code 4 is activated.	Lower range value for travel/angle in nominal or operating range The operating range is the actual travel/angle of the valve and is limited by the lower travel/angle range value (Code 8) and the upper travel/angle range value (Code 9). Usually, the operating range and the nominal range are identical. The nominal range can be limited to the operating range by the lower and upper x-range values. The value is displayed or must be entered. The characteristic is adapted. See also the example in Code 9.

Code no.	Parameter – Readings/ values [default setting]	Description
9*	Travel/angle range end (upper x-range value) 20.0 to [100.0 %] of the nominal range, ESC <i>Note: Specified in mm or angle ° provided Code 4 is activated.</i>	Upper range value for travel/angle in nominal or operating range The value is displayed or must be entered. The characteristic is adapted. Example: The operating range is modified, for example to limit the range of a control valve which has been sized too large. For this function, the entire resolution range of the set point is converted to the new limits. 0 % on the display corresponds to the adjusted lower limit and 100 % to the adjusted upper limit.
10*	Travel/angle lower limit (lower x-limit) 0.0 to 49.9 % of the operating range, [No], ESC	Limits travel/opening angle to the entered value (lower limit). The characteristic is not adapted. The characteristic is not adapted to the reduced range. See also example in Code 11.
11*	Travel/angle upper limit (upper x-limit) 50.0 to 120.0 %, [100 %] of the operating range, No, ESC	Limits travel/angle to the entered value (upper limit). The characteristic is not adapted. Example: In some applications, it is better to limit the valve travel, e.g. if a certain minimum medium flow is required or a maximum flow must not be reached. The lower limit must be adjusted with Code 10 and the upper limit with Code 11. If a tight-closing function has been set up, it has priority over the travel limitation. When set to No, the valve can be opened past the rated travel with a set point outside of the 0 to 100 % range.
14*	Set point cutoff decrease 0.0 to 49.9 %, [1.0 %] of the span adjusted in Code 12/13, No, ESC	If the set point w reaches up to the entered percentage at the final value that causes the valve to close, the actuator is immediately completely vented (with AIR TO OPEN) or filled with air (with AIR TO CLOSE). This action always lead to maximum tight-closing of the valve. Codes 14/15 have priority over Codes 8/9/10/11. Codes 21/22 have priority over Codes 14/15.

Annex A (configuration instructions)

Code no.	Parameter – Readings/ values [default setting]	Description
15*	Set point cutoff increase 50.0 to 100.0 % of the span adjusted in Code 12/13, [No], ESC	<p>If the set point w reaches up to the entered percentage at the final value that causes the valve to open, the actuator is immediately filled with air (with AIR TO OPEN) or completely vented (with AIR TO CLOSE). This action always leads to the valve being completely opened. The signal pressure can be limited in Code 16.</p> <p>Codes 14/15 have priority over Codes 8/9/10/11. Codes 21/22 have priority over Codes 14/15.</p> <p>Example: set the cutoff to 99 % for three-way valves.</p>
16*	Pressure limit 1.4, 2.4, 3.7 bar, [No], ESC	<p>The signal pressure to the actuator can be limited in stages.</p> <p>After changing a pressure limit already set, the actuator must be vented once (e.g. by selecting the fail-safe position (SAFE) over Code 0).</p> <p>NOTICE</p> <p><i>Do not activate pressure limitation for double-acting actuators (with closed position AIR TO OPEN).</i></p>
17*	Proportional-action coefficient K_p (level) 0 to 17, [7], ESC	<p>Read or change K_p</p> <p>Note concerning changing the K_p and T_V levels: During positioner initialization, the values for K_p and T_V are optimally set. If the positioner tends to overshoot impermissibly due to other disturbances, the K_p and T_V levels can be adapted accordingly after initialization. Increment T_V level until desired behavior is reached or when the maximum value of 4 is reached, the K_p level can be decreased in increments.</p> <p>K_p level changes affect the set point deviation.</p>
18*	Derivative-action time T_V (level) 1, [2], 3, 4, No, ESC	<p>Read or change T_V (see K_p level)</p> <p>A change of the T_V level has no effect on the system deviation.</p>
19*	Tolerance band 0.1 to 10.0 %, [5.0 %] of the operating range, ESC	<p>Used for error monitoring.</p> <p>Determination of the tolerance band in relation to the operating range.</p> <p>Associated lag time (30 s) is a reset criterion.</p> <p>If a transit time is determined during initialization which is six times longer than 30 s, the six-fold transit time is accepted as the lag time.</p>

Code no.	Parameter – Readings/ values [default setting]	Description
20*	Characteristic [0] to 9, ESC	Valve characteristic selection 0 Linear 1 Equal percentage 2 Reverse equal percentage 3 SAMSON butterfly valve, linear 4 SAMSON butterfly valve, equal percentage 5 VETEC rotary plug valve, linear 6 VETEC rotary plug valve, equal percentage 7 Segmented ball valve, linear 8 Segmented ball valve, equal percentage 9 User-defined (defined over operator software) i Note <i>The various characteristics are listed in section 16.2.</i>
21*	Required transit time OPEN (w ramp open) [0] to 240 s, ESC	Time required to move through the operating range when the valve opens. Limitation of the transit time (Code 21 and 22): For some applications it is recommendable to limit the transit time of the actuator to prevent it from engaging too fast in the running process. Code 21 has priority over Code 15. NOTICE <i>The function is not activated when the fail-safe function or solenoid valve is triggered nor upon failure of the auxiliary power.</i>
22*	Required transit time CLOSED (w ramp closed) [0] to 240 s, ESC	Time required to move through the operating range when the valve closes. Code 22 has priority over Code 14. NOTICE <i>The function is not activated when the fail-safe function or solenoid valve is triggered nor upon failure of the auxiliary power.</i>
23*	Total valve travel [0] to $99 \cdot 10^7$, RES, ESC Exponential reading from 9999 travel cycles onwards	Totalled full valve travel cycle Can be reset to 0 by selecting RES. i Note <i>The total valve travel is saved in a non-volatile memory after every 1000 full valve travel cycle.</i>

Annex A (configuration instructions)

Code no.	Parameter – Readings/ values [default setting]	Description
24*	LV total valve travel 1000 to $99 \cdot 10^7$ [1.000000], ESC Exponential reading from 9999 travel cycles onwards	Limit value of total valve travel. If the limit is exceeded, the error message and the  icon corresponding to the condensed state appear.
34*	Closing direction CL, [CCL], ESC	CL: Clockwise CCL: Counterclockwise Direction of rotation to reach the valve's CLOSED position (view onto rotary switch with positioner cover open). Needs only be entered in SUB initialization mode (Code 6).
35*	Blocking position [0.0] mm/° /%, ESC	Enter the blocking position (distance to CLOSED position) Only necessary with Sub initialization mode.
36*	Reset [----], Std, diAG, ESC	Std: Resets all parameters and diagnosis data to their default settings. After a reset, the positioner must be re-initialized. diAG: Resets diagnosis data only. Plotted reference graphs and logs remain saved. The positioner does not need to be re-initialized.
38*	Inductive alarm [No], YES, ESC	Indicates whether the inductive limit switch option is installed or not.
39	Set point deviation e info -99.9 to 99.9 %	Read only Indicates the deviation from the target position.
40	Transit time Open info [0] to 240 s	Read only Minimum opening time determined during initialization.
41	Transit time Closed info [0] to 240 s	Read only Minimum closing time determined during initialization.
42	Auto-w/manual-w info 0.0 to 100.0 % of the span	Read only Auto mode: Indicates the applied automatic set point. Man mode: Indicates the applied manual set point.

Code no.	Parameter – Readings/values [default setting]	Description
43	Firmware info control	Read only Indicates the positioner type and current firmware version in alternating sequence.
44	y info [0] to 100 %, OP, MAX, – – –	Read only Indicates the control signal y in % in relation to the travel range determined during initialization. MAX: The positioner builds up its maximum output pressure, see description in Code 14 and 15. OP: The positioner vents completely, see description in Code 14 and 15. – – –: The positioner is not initialized.
45	Solenoid valve info YES, HIGH/LOW, No	Read only Indicates whether a solenoid valve is installed or not. If a voltage supply is connected at the terminals of the installed solenoid valve, YES and HIGH appear on the display in alternating sequence. If a voltage supply is not connected (actuator vented, fail-safe position indicated on the display by the S icon), YES and LOW appear on the display in alternating sequence.
46*	Bus address ESC	Bus address
47*	Write protection PA YES, [No], ESC	When write protection is active, device data can be read using PA communication but not overwritten.
48* 49*	Diagnostic parameters ► EB 8389	

16.1.1 Error codes

Initialization errors

Error codes – Recommended action		Condensed state message active, when prompted, Err appears. When fault alarms exist, they are displayed here.
50	x > permissible range	Value of measuring signal too high or too low; the lever operates near its mechanical stops. <ul style="list-style-type: none"> • Pin not mounted properly • Bracket slipped in case of NAMUR attachment or positioner is off center. • Follower plate not mounted properly.
	Status classification	[Maintenance required]
	Recommended action	Check attachment and pin position, set operating mode from SAFE to MAN and re-initialize the positioner.
51	$\Delta x < \text{permissible range}$	Insufficient measuring span of the lever. <ul style="list-style-type: none"> • Pin not mounted properly • Wrong lever <p>An angle of rotation smaller than 16° at the positioner shaft only generates an alarm. An angle below 9° leads to the initialization being canceled.</p>
	Status classification	[Maintenance required]
	Recommended action	Check attachment and re-initialize the positioner.
52	Attachment	<ul style="list-style-type: none"> • Invalid positioner attachment • Rated travel/angle (Code 5) could not be achieved during NOM initialization (no tolerance downwards permissible). • Mechanical or pneumatic fault, e.g. wrong lever selected or supply pressure too low to move to the required position.
	Status classification	[Maintenance required]
	Recommended action	Check attachment and supply pressure. Re-initialize the positioner. Under certain circumstances, it may be possible to check the maximum travel/angle by entering the actual pin position and then performing a MAX initialization. After initialization has been completed, the Code 5 indicates the maximum achieved travel or angle.

Error codes – Recommended action		Condensed state message active, when prompted, <i>Err</i> appears. When fault alarms exist, they are displayed here.
53	Initialization time exceeded (Init time >)	Initialization takes too long. The positioner returns to the previous operating mode. <ul style="list-style-type: none"> • No pressure in supply line or pneumatic leakage • Supply air failure during initialization
	Status classification	[Maintenance required]
	Recommended action	Check attachment and supply air line. Re-initialize the positioner.
54	Initialization – solenoid valve	<ol style="list-style-type: none"> 1) A solenoid valve is installed (Code 45 = YES) and has not been connected or not properly. As a result, actuator pressure cannot build up. The alarm is generated when you attempt to initialize the positioner. 2) If you attempt to initialize the positioner from the fail-safe position (SAFE).
	Status classification	[Maintenance required]
	Recommended action	<ol style="list-style-type: none"> 1) Check connection and supply voltage of the solenoid valve (Code 45 High/Low). 2) Set the MAN mode in Code 0. Re-initialize the positioner.
55	Transit time too short (transit time <)	Actuator transit times detected during initialization are so short that optimal positioner tuning is impossible.
	Status classification	[Maintenance required]
	Recommended action	Check the volume restriction setting as described in section 7.2. Re-initialize the positioner.
56	Pin position	Initialization canceled because selected NOM and SUB initialization modes require the pin position to be entered.
	Status classification	[Maintenance required]
	Recommended action	Enter pin position over Code 4 and rated travel/angle over Code 5. Re-initialize the positioner.

Operational errors

Error codes – Recommended action		Condensed state message active, when prompted, Err appears. When fault alarms exist, they are displayed here.
57	Control loop	Control loop error, the valve no longer follows the controlled variable within tolerable times (tolerance band alarm Code 19). <ul style="list-style-type: none"> • Actuator blocked • Positioner attachment shifted subsequently • Supply pressure no longer suffices.
	Status classification	[Maintenance required]
	Recommended action	Check attachment.
58	Zero point	Zero point incorrect Error can occur when the positioner's attachment position is shifted or when the valve trim is worn, particularly with soft-sealed plugs.
	Status classification	[Maintenance required]
	Recommended action	Check valve and attachment of the positioner. If OK, perform a zero calibration over Code 6 (see section 7.7). We recommend to re-initialize the positioner if zero deviates by more than 5 %.
59	Auto-correction	Errors in the positioner's data section are detected detected by automatic monitoring and corrected automatically.
	Status classification	[No message]
	Recommended action	Automatic
60	Fatal error	Error in safety-relevant data that cannot be corrected automatically. Possible cause: EMC disturbances. The valve is moved to fail-safe position.
	Status classification	Maintenance alarm (cannot be classified)
	Recommended action	Reset over Code 36. Re-initialize the positioner.

Hardware errors

Error codes – Recommended action		Condensed state message active, when prompted, <i>Err</i> appears. When fault alarms exist, they are displayed here.
62	x signal	<p>Actuator's measured value recording failed. The conductive plastic element is defective. The device continues functioning in emergency mode but it must be replaced as quickly as possible. The emergency mode on the display is indicated by a blinking closed-loop operation icon and 4 dashes instead of the position reading.</p> <p>Note on the open-loop operation: <i>If the measuring system has failed, the positioner is still in a reliable state. The positioner switches to emergency mode where the position cannot be accurately controlled anymore. However, the positioner continues operation according to its set point so that the process remains in a safe state.</i></p>
	Status classification	[Maintenance demanded]
	Recommended action	Return device to SAMSON for repair.
64	i/p converter (y)	Current circuit of i/p converter interrupted.
	Status classification	Maintenance alarm (cannot be classified)
	Recommended action	Cannot be remedied. Return device to SAMSON for repair.

Annex A (configuration instructions)

Errors

Error codes – Recommended action		Condensed state message active, when prompted, Err appears. When fault alarms exist, they are displayed here.
65	Hardware	Initialization key jammed A hardware error has occurred. The positioner changes to the fail-safe position (SAFE).
	Status classification	Maintenance alarm (cannot be classified)
	Recommended action	Confirm error and return to automatic mode or perform a reset and re-initialize the positioner. In the problem still persists, return device to SAMSON for repair.
66	Data memory	No more data can be written to the memory, e.g. because written data deviate from read data. The valve moves to the fail-safe position.
	Status classification	Maintenance alarm (cannot be classified)
	Recommended action	Return device to SAMSON for repair.
67	Check calculation	Hardware controller monitored by test calculation.
	Status classification	Maintenance alarm (cannot be classified)
	Recommended action	Confirm error. If this is not possible, return the device to SAMSON for repair.

Data errors

Error codes – Recommended action		Condensed state message active, when prompted, <i>Err</i> appears. When fault alarms exist, they are displayed here.
68	Control parameters	Error in control parameters.
	Status classification	[Maintenance required]
	Recommended action	Confirm error, perform a reset and re-initialize the positioner.
69	Potentiometer parameters	Error in digital potentiometer parameters
	Status classification	[Maintenance required]
	Recommended action	Confirm error, perform a reset and re-initialize the positioner.
70	Calibration	Error in data from production calibration. The positioner continues operation with cold start values.
	Status classification	[Maintenance required]
	Recommended action	Return device to SAMSON for repair.
71	General parameters	Error in parameters not critical to control operation.
	Status classification	[Maintenance required]
	Recommended action	Confirm error. Check and, if necessary, change the settings of the required parameters.
73	Internal device error 1	Internal device error
	Status classification	[Maintenance required]
	Recommended action	Return device to SAMSON for repair.
74	PA parameters	Error in parameters not critical to control operation.
	Status classification	[Maintenance required]
	Recommended action	Confirm error and perform a reset.

Annex A (configuration instructions)

Error codes – Recommended action		Condensed state message active, when prompted, Err appears. When fault alarms exist, they are displayed here.
76	No emergency mode	The travel measuring system of the positioner has a self-monitoring function (see Code 62). An emergency mode (open-loop control) is not available for certain actuators, such as double-acting actuators. In case of a travel sensing error, the positioner vents the output (Output 38) or A1 in double-acting actuators. During the initialization, the positioner automatically checks whether the actuator has such a function or not.
	Status classification	[No message]
	Recommended action	Merely information, confirm, if necessary. No further action required.
77	Software loading error	When the positioner starts operation for the first time after the PA signal has been applied, it carries out a self-test (tESinG runs across the display). If the positioner loads the wrong software, the valve moves to the fail-safe position. It is not possible to make the valve leave this fail-safe position again.
	Status classification	Maintenance alarm (cannot be classified)
	Recommended action	Interrupt fieldbus signal and restart the positioner. If not successful, return device to SAMSON for repair.
78	Option parameters	Error in option parameters.
	Status classification	[Maintenance required]
	Recommended action	Return device to SAMSON for repair.

Diagnosis errors

Error codes – Recommended action		Condensed state message active, when prompted, <i>Err</i> appears. When fault alarms exist, they are displayed here.
79	Diagnostic messages	Messages generated by the EXPERTplus extended diagnostics
	Status classification	Maintenance required (cannot be classified)
80	Diagnostic parameters	Error in parameters not critical to control operation.
	Status classification	Maintenance required (cannot be classified)
	Recommended action	Confirm error. Check and, if necessary, perform a new reference test.
81	Reference graphs	Error occurred during plotting the reference graphs for drive signal y steady-state or drive signal y hysteresis. <ul style="list-style-type: none"> • Reference test canceled • Reference line for drive signal y steady-state or drive signal y hysteresis was not adopted.
	Status classification	[No message]
	Recommended action	Check and, if necessary, perform a new reference test.

16.2 Valve characteristic selection

The characteristics that can be selected in Code 20 are shown in the following in graph form.

i Note

A characteristic can only be defined (user-defined characteristic) using a workstation/operating software (e.g. TROVIS-VIEW).

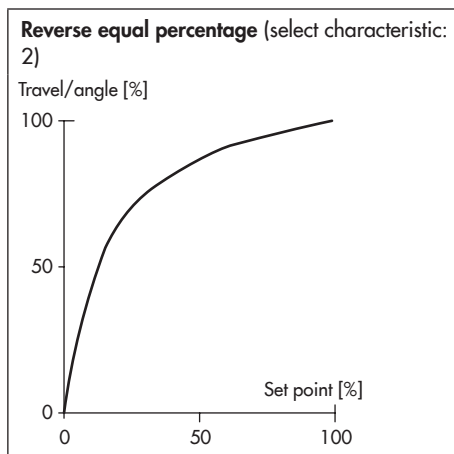
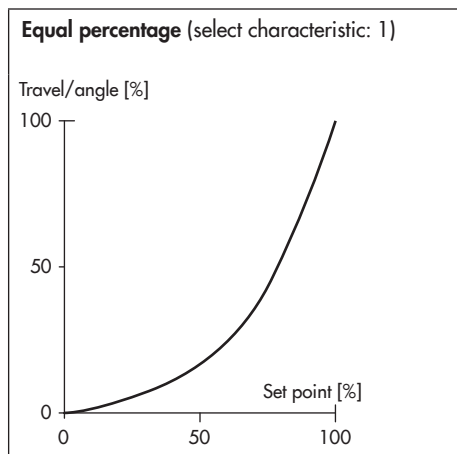
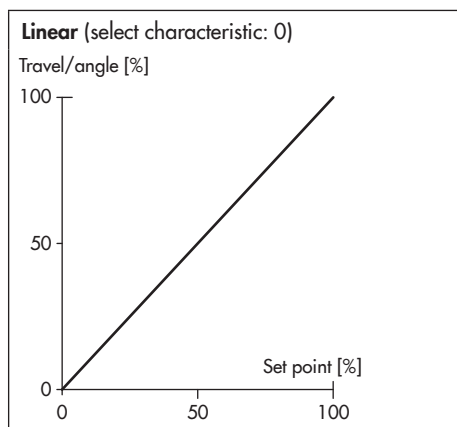

SAMSON butterfly valve linear (select characteristic: 3)

Travel/angle [%]
100
50
0

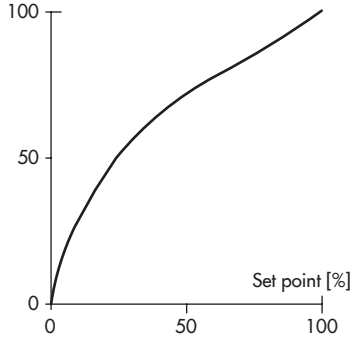

SAMSON butterfly valve equal percentage

(select characteristic: 4)
Travel/angle [%]
100
50
0

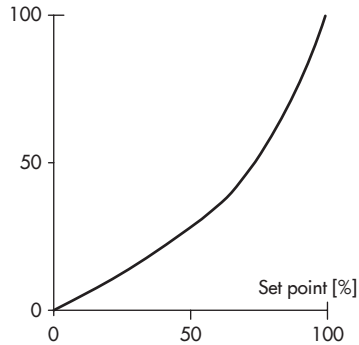

VETEC rotary plug valve linear (select characteristic: 5)

Travel/angle [%]
100
50
0

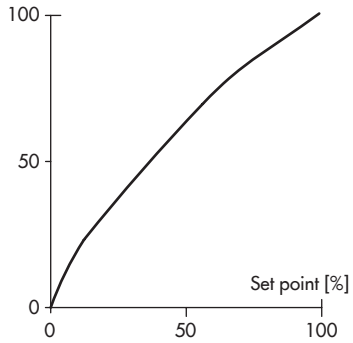

VETEC rotary plug valve equal percentage

(select characteristic: 6)
Travel/angle [%]
100
50
0

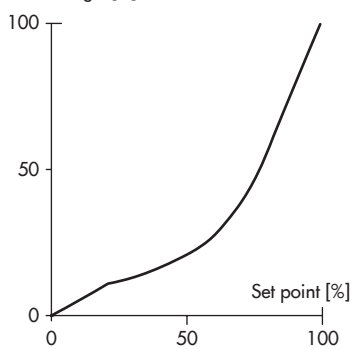

Segmented valve ball linear (select characteristic: 7)

Travel/angle [%]
100
50
0

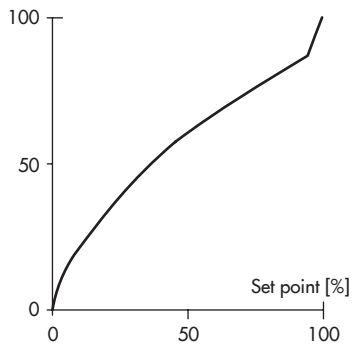

Segmented valve ball equal percentage (select characteristic: 8)

Travel/angle [%]
100
50
0

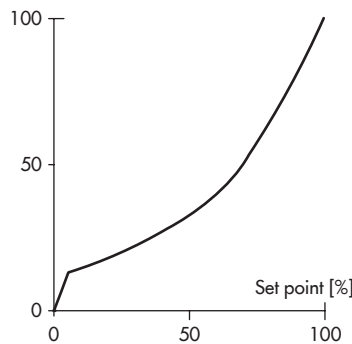

17 Annex B

17.1 Accessories

Table 17-1: *General accessories*

Designation		Order no.
Reversing amplifier for double-acting actuators		Type 3710
M20x1.5 cable gland	Black plastic (6 to 12 mm clamping range)	8808-1011
	Blue plastic (6 to 12 mm clamping range)	8808-1012
	Nickel-plated brass (6 to 12 mm clamping range)	1890-4875
	Nickel-plated brass (10 to 14 mm clamping range)	1992-8395
	Stainless steel 1.4305 (8 to 14.5 mm clamping range)	8808-0160
Adapter M20x1.5 to ½ NPT	Powder-coated aluminum	0310-2149
	Stainless steel	1400-7114
Lever	S	0510-0522
	M	0510-0510
	L	0510-0511
	XL	0510-0512
	XXL	0510-0525
Retrofit kit for inductive limit switch 1 x SJ2-SN		1402-1770
Isolated USB interface adapter (SSP interface to USB port on a computer) including TROVIS-VIEW CD-ROM		1400-9740
TROVIS-VIEW 6661 (▶ www.samsongroup.com > SERVICE & SUPPORT > Downloads > TROVIS-VIEW)		

Table 17-2: *Direct attachment to Type 3277-5 Actuator*

Designation		Order no.	
Mounting parts	Standard version for actuators 120 cm ² or smaller	1400-7452	
	Version compatible with paint for actuators 120 cm ² or smaller	1402-0940	
Accessories for actuator	Old switchover plate for Type 3277-5xxxxx.00 Actuator (old)	1400-6819	
	New switchover plate for Type 3277-5xxxxx.01 Actuator (new) ¹⁾	1400-6822	
	New connecting plate for Type 3277-5xxxxx.01 Actuator (new) ¹⁾ , G ¼ and ½ NPT	1400-6823	
	Old connecting plate for Type 3277-5xxxxx.00 Actuator (old): G ¼	1400-6820	
	Old connecting plate for Type 3277-5xxxxx.00 (old): ½ NPT	1400-6821	
Accessories for positioner	Connecting plate (6)	G ¼	1400-7461
		¼ NPT	1400-7462

Annex B

Designation		Order no.	
Accessories for positioner	Pressure gauge bracket (7)	G ¼	1400-7458
		¼ NPT	1400-7459
	Pressure gauge mounting kit (8) up to max. 6 bar	Stainless steel/brass	1402-1637
		Stainless steel/stainless steel	1402-1638

¹⁾ Only new switchover and connecting plates can be used with new actuators (Index 01). Old and new plates are not interchangeable.

Table 17-3: Direct attachment to Type 3277 Actuator

Mounting parts/accessories	Order no.	
Standard version for actuators 175, 240, 350, 355, 700, 750 cm ²	1400-7453	
Version compatible with paint for actuators 175, 240, 350, 355, 700, 750 cm ²	1402-0941	
Connection block with seals and screw	G ¼	1400-8819
	¼ NPT	1402-0901
Pressure gauge mounting kit up to max. 6 bar	Stainless steel/brass	1402-1637
	Stainless steel/stainless steel	1402-1638
Piping with screw fittings ¹⁾	Order no.	
Actuator (175 cm ²), steel	G ¼/G ¾	1402-0970
	¼ NPT/¾ NPT	1402-0976
Actuator (175 cm ²), stainless steel	G ¼/G ¾	1402-0971
	¼ NPT/¾ NPT	1402-0978
Actuator (240 cm ²), steel	G ¼/G ¾	1400-6444
	¼ NPT/¾ NPT	1402-0911
Actuator (240 cm ²), stainless steel	G ¼/G ¾	1400-6445
	¼ NPT/¾ NPT	1402-0912
Actuator (350 cm ²), steel	G ¼/G ¾	1400-6446
	¼ NPT/¾ NPT	1402-0913
Actuator (350 cm ²), stainless steel	G ¼/G ¾	1400-6447
	¼ NPT/¾ NPT	1402-0914
Actuator (355 cm ²), steel	G ¼/G ¾	1402-0972
	¼ NPT/¾ NPT	1402-0979
Actuator (355 cm ²), stainless steel	G ¼/G ¾	1402-0973
	¼ NPT/¾ NPT	1402-0980
Actuator (700 cm ²), steel	G ¼/G ¾	1400-6448
	¼ NPT/¾ NPT	1402-0915
Actuator (700 cm ²), stainless steel	G ¼/G ¾	1400-6449
	¼ NPT/¾ NPT	1402-0916

Mounting parts/accessories		Order no.
Actuator (750 cm ²), steel	G ¼/G ¾	1402-0974
	¼ NPT/¾ NPT	1402-0981
Actuator (750 cm ²), stainless steel	G ¼/G ¾	1402-0975
	¼ NPT/¾ NPT	1402-0982

- ¹⁾ for "actuator stem retracts" fail-safe action
with air purging of the top diaphragm chamber

Table 17-4: Attachment to NAMUR rib or attachment to rod-type yokes ¹⁾ according to IEC 60534-6

Travel in mm	Lever	For actuator	Order no.
7.5	S	Type 3271-5 with 60/120 cm ² on Type 3510 Micro-flow Valve	1402-0478
5 to 50	M ²⁾	Actuators from other manufacturers and Type 3271 with 120 to 750 cm ² effective areas	1400-7454
14 to 100	L	Actuators from other manufacturers and Type 3271 with 1000 and 1400-60 cm ²	1400-7455
30 or 60	L	Type 3271, 1400-120 and 2800 cm ² versions with 30/60 mm travel ³⁾	1400-7466
		Mounting brackets for Emerson and Masoneilan linear actuators (in addition, a mounting kit according to IEC 60534-6 is required depending on the travel). See rows above.	1400-6771
		Valtek Type 25/50	1400-9554
40 to 200	XL	Actuators from other manufacturers and Type 3271 with 1400-120 and 2800 cm ² and with 120 mm travel	1400-7456
Accessories			Order no.
Connecting plate		G ¼	1400-7461
		¼ NPT	1400-7462
Pressure gauge bracket		G ¼	1400-7458
		¼ NPT	1400-7459
Pressure gauge mounting kit up to max. 6 bar		Stainless steel/brass	1402-1637
		Stainless steel/stainless steel	1402-1638

- ¹⁾ 20 to 35 mm rod diameter

- ²⁾ M lever is mounted on basic device (included in the scope of delivery)

- ³⁾ In conjunction with Type 3273 Side-mounted Handwheel with 120 mm rated travel, additionally one bracket (0300-1162) and two countersunk screws (8330-0919) are required.

Table 17-5: Attachment according to VDI/VDE 3847-1

Mounting parts			Order no.
VDI/VDE 3847 interface adapter			1402-0257
Connecting plate, including connection for air purging of actuator spring chamber	Aluminum	ISO 228/1-G ¼	1402-0268
		¼-18 NPT	1402-0269
	Stainless steel	ISO 228/1-G ¼	1402-0270
		¼-18 NPT	1402-0271
Mounting kit for attachment to SAMSON Type 3277 Actuator with 175 to 750 cm ²			1402-0868
Mounting kit for attachment to SAMSON Type 3271 Actuator or third-party actuators			1402-0869
Travel pick-off for valve travel up to 100 mm			1402-0177
Travel pick-off for 100 to 200 mm valve travel (SAMSON Type 3271 Actuator only)			1402-0178

Table 17-6: Attachment according to VDI/VDE 3847-2

Designation		Order no.
Mounting parts	Mounting block for PFEIFFER Type 31a (edition 2020+) Rotary Actuators with blank plate for solenoid valve interface	1402-1645
	Dummy plate for solenoid valve interface (sold individually)	1402-1290
	Adapter bracket for Type 3730 (VDI/VDE 3847)	1402-0257
	Adapter bracket for Type 3730 and Type 3710 (DAP/PST)	1402-1590
Accessories for actuator	Shaft adapter AA1	1402-1617
	Shaft adapter AA2	1402-1616
	Shaft adapter AA4	1402-1888

Table 17-7: Attachment to rotary actuators

Mounting parts/accessories	Order no.
Attachment according to VDI/VDE 3845 (September 2010), actuator surface corresponds to fixing level 1	
Size AA1 to AA4, version with CrNiMo steel bracket	1400-7448
Size AA1 to AA4, heavy-duty version	1400-9244
Size AA5, heavy-duty version (e.g. Air Torque 10 000)	1400-9542
Bracket surface corresponds to fixing level 2, heavy-duty version	1400-9526
Attachment for rotary actuators with max. 180° opening angle, fixing level 2	1400-8815 and 1400-9837
Attachment to SAMSON Type 3278 with 160/320 cm ² , CrNiMo steel bracket	1400-7614
Attachment to SAMSON Type 3278 with 160 cm ² and to VETEC Type S160, Type R and Type M, heavy-duty version	1400-9245

Mounting parts/accessories		Order no.
Attachment to SAMSON Type 3278 with 320 cm ² and to VETEC Type S320, heavy-duty version		1400-5891 and 1400-9526
Attachment to Camflex II		1400-9120
Accessories	Connecting plate	G ¼ ¼ NPT
	Pressure gauge bracket	G ¼
		¼ NPT
	Pressure gauge mounting kit up to max. 6 bar	Stainless steel/brass
Stainless steel/stainless steel		

Table 17-8: Attachment of external position sensor

Mounting parts/accessories		Order no.
Template for mounting position sensor on older mounting parts		1060-0784
Direct attachment	Mounting parts for actuator with 120 cm ²	1400-7472
	Connecting plate (9, old) with Type 3277-5xxxxxx.00 Actuator	G ⅛
		⅛ NPT
	Connecting plate (new) with Type 3277-5xxxxxx.01 Actuator (new) ¹⁾	1400-6823
Mounting parts for actuators with 175, 240, 350, 355 and 750 cm ²		1400-7471
NAMUR attachment	Mounting parts for attachment to NAMUR rib using L or XL lever	1400-7468
Attachment to Type 3510 Micro-flow Valve	Mounting parts for Type 3271 Actuator with 60 cm ²	1400-7469
Attachment to rotary actuators	VDI/VDE 3845 (September 2010), see the 'Design and principle of operation' section for details.	
	Actuator surface corresponds to fixing level 1	
	Size AA1 to AA4 with follower clamp and coupling wheel, version with CrNiMo steel bracket	1400-7473
	Size AA1 to AA4, heavy-duty version	1400-9384
	Size AA5, heavy-duty version (e.g. Air Torque 10 000)	1400-9992
	Bracket surface corresponds to fixing level 2, heavy-duty version	1400-9974
SAMSON Type 3278 with 160 cm ² and VETEC Type S160 and Type R, heavy-duty version		1400-9385
SAMSON Type 3278 with 320 cm ² and VETEC Type S320, heavy-duty version		1400-5891 and 1400-9974

Mounting parts/accessories		Order no.	
Accessories for positioner	Connecting plate (6)	G ¼	1400-7461
		¼ NPT	1400-7462
	Pressure gauge bracket (7)	G ¼	1400-7458
		¼ NPT	1400-7459
	Pressure gauge mounting kit up to max. 6 bar	Stainless steel/brass	1402-1637
		Stainless steel/stainless steel	1402-1638
Bracket to mount the positioner on a wall (Note: The other fastening parts are to be provided at the site of installation as wall foundations vary from site to site).		0309-0184	

¹⁾ Only new connecting plates can be used with new actuators (Index 01). Old and new plates are not interchangeable.

17.2 After-sales service

Contact our after-sales service for support concerning service or repair work or when malfunctions or defects arise.

E-mail contact

You can reach our after-sales service at aftersalesservice@samsongroup.com.

Addresses of SAMSON AG and its subsidiaries

The addresses of SAMSON AG, its subsidiaries, representatives and service facilities worldwide can be found on our website (www.samsongroup.com) or in all SAMSON product catalogs.

Required specifications

Please submit the following details:

- Order number and position number in the order
- Specifications on the nameplate:
 - Supply pressure
 - Explosion protection marking
 - Date of manufacture
 - Firmware version
 - Configuration ID
 - Serial number
 - Model number

EB 8384-4 EN



SAMSON AKTIENGESELLSCHAFT
Weismüllerstraße 3 · 60314 Frankfurt am Main, Germany
Phone: +49 69 4009-0 · Fax: +49 69 4009-1507
samson@samsongroup.com · www.samsongroup.com