

SAMSON

SAMSON

REFERENCES

## High-efficiency Heat Exchanger Systems

Sample Application:  
Residential District in Nottingham, UK



District Energy

# Applications

## ■ Automation



### CPU module

- Scalable automation system
- Integrated web visualization
- E-mail, text message
- Modbus/BACnet



### Web terminal

- Multi-touch panel
- 7" color TFT display
- Power over Ethernet (PoE)
- USB port for historical data



### Modbus-GPRS gateway

- Access using Internet/GPRS
- Remote maintenance
- Connection of heat meters
- Alarm management

## ■ Control

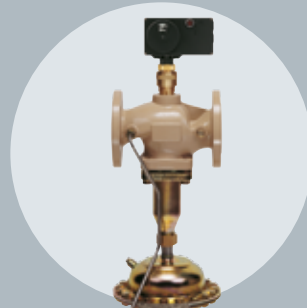

### Pressure-independent control valve (PICV)

- Electric control valve
- Adjustable flow rate
- Independent of network pressure conditions



### Safety temperature monitor

- Protects domestic systems against excessive temperatures
- Alerts CPU of excess temperatures
- Automatic reset

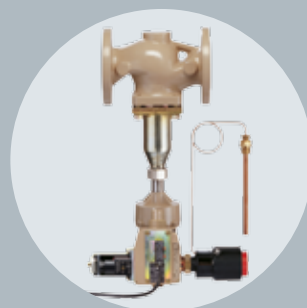

### Safety temperature limiter with pressure element

- Shuts off heat source
- Protects domestic systems against excessive pressure
- Alerts CPU of triggered fail-safe action

# Heat exchangers

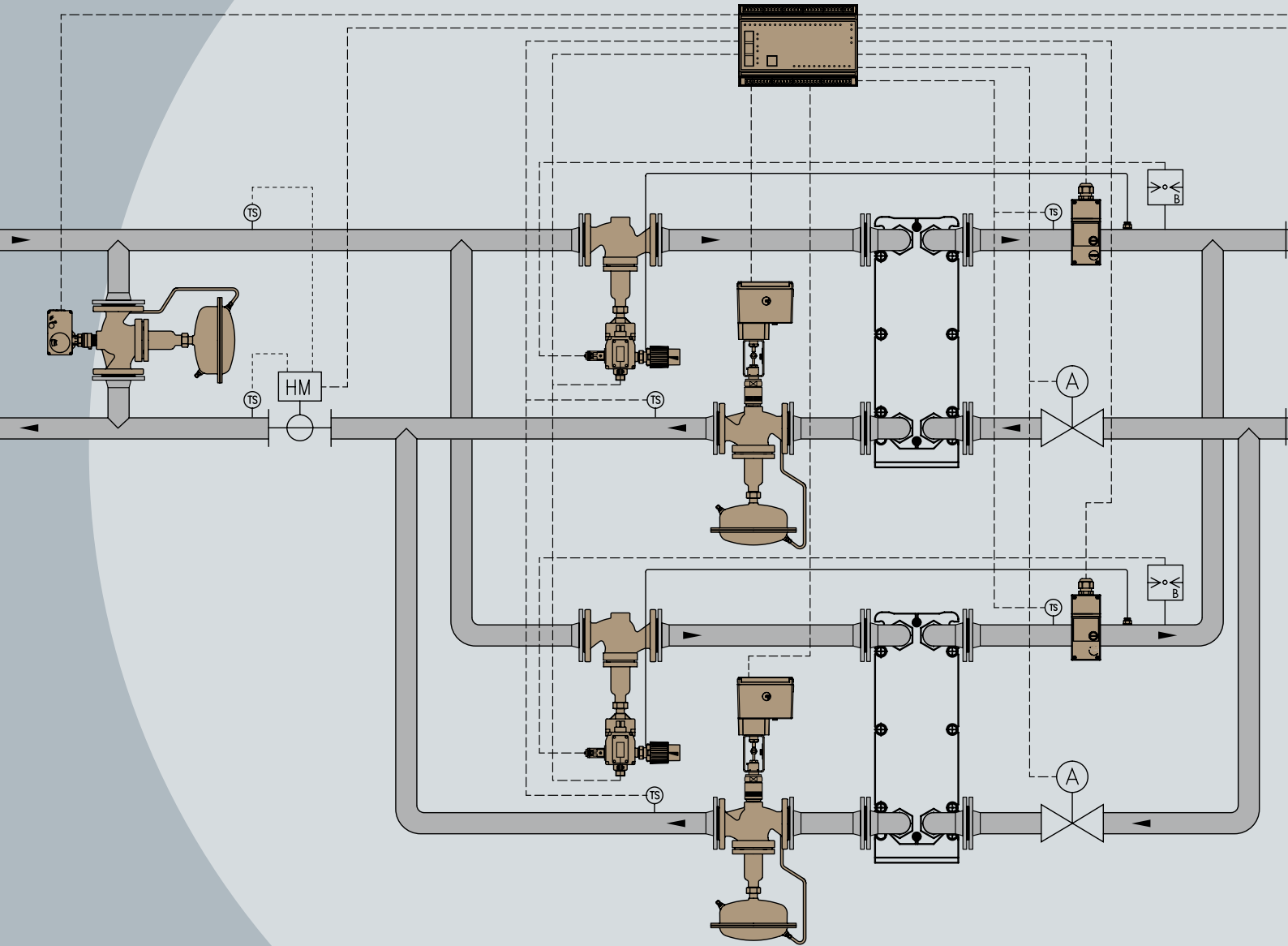

# Smart Automation

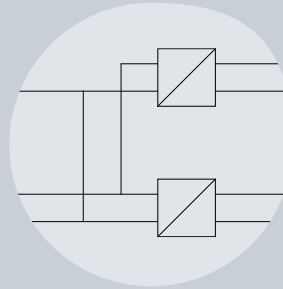
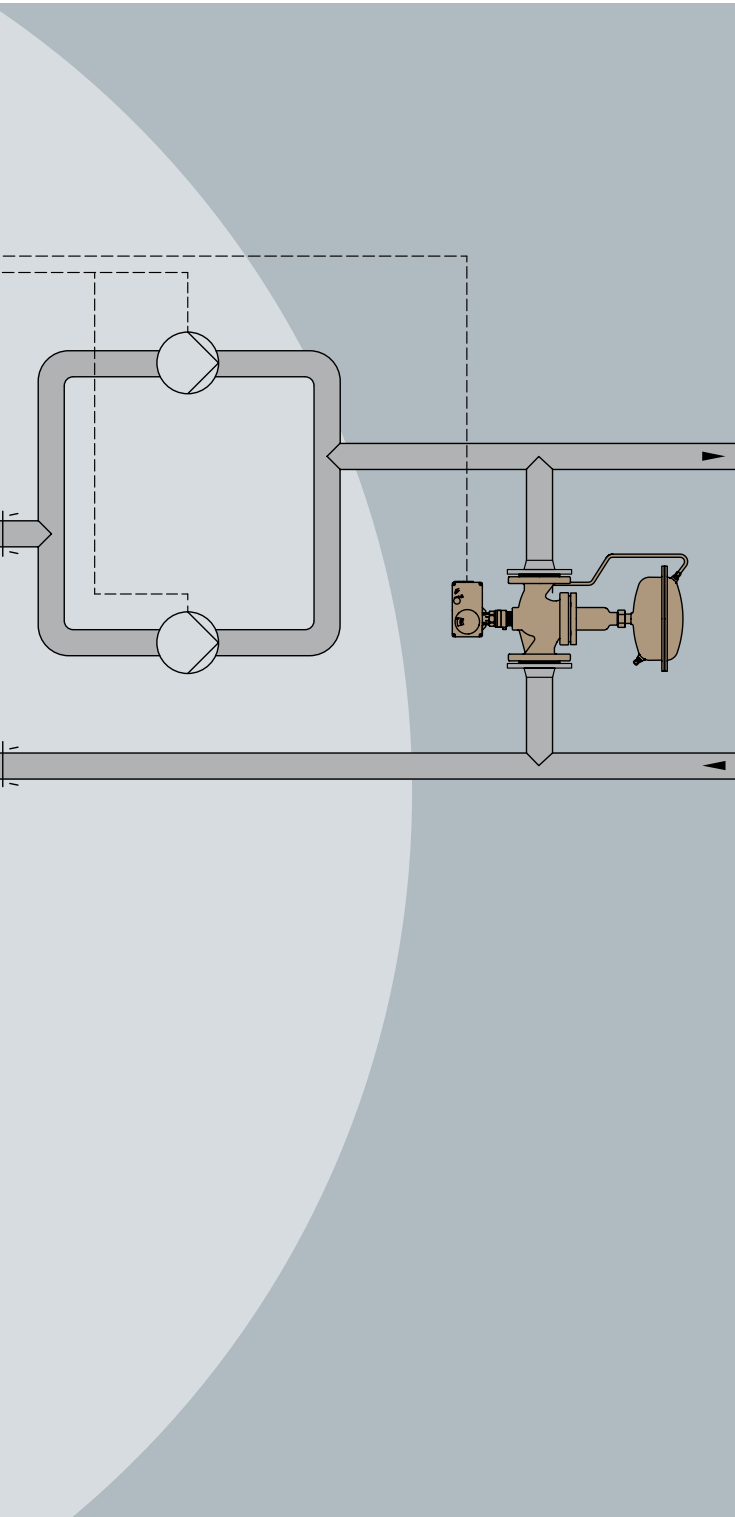

## Heat exchangers

- Sequence switched based on operating hours
- Error detection
- Return flow temperature limitation

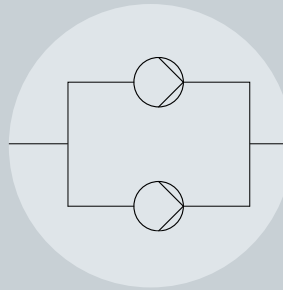

## Double pumps

- Differential pressure control
- Pump bypass
- Manual mode

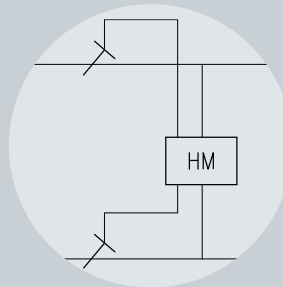

## Metering

- Connection using M-bus
- Automatic logging
- Data export for billing

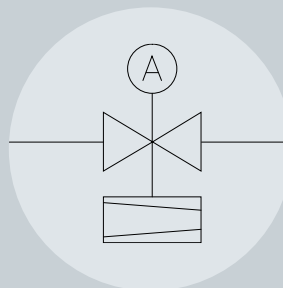

## Pump protection

- Minimal flow rate for pumps
- Defined pressure drop at minimal flow rate

# References: District Energy

## Heat Supply in Residential Areas

An example of smart automation is the residential area scheme implemented in the English city of Nottingham. Vital Energi, Enviro Energy, and SAMSON Controls joined forces to create one plant for two residential areas. They are connected to the existing district heating network using a heat transfer station.

At each station, heat exchanger sequence control is implemented but sized and configured differently to cater for the different capacities consumed in the secondary circuit. The first station comes with two heat exchangers, each delivering 600 kW at a connection size of DN 65. In the primary circuit, the temperature ratio is 110 °C to 70 °C, in the secondary circuit 85 °C to 65 °C. In the second station, delivery of each heat exchanger is 1 MW with a connection size of DN 80 installed in the primary circuit and DN 125 in the secondary circuit.



## Flow Under Control

The electric control valves in heat transfer stations take over various control tasks and, as a result, they must meet a whole range of requirements.

The control valves are designed to ensure stable operation and accurate control regardless of the differential pressure in the district heating network. The plant components must be operated at a certain flow rate to distribute the heat capacity to the heat exchangers, protect the pumps, and keep the supply pipes at a certain temperature. Additionally, the valves ensure that certain operating temperatures and pressures are maintained. For this purpose, Type 42-36 E and Type 2488 Pressure-independent Control Valves are used in combination with Type 3374-21 and Type 5825 Actuators with fail-safe action.



## Heat Exchanger Sequence

Each heat exchanger is fitted with an electric control valve in the primary circuit and a shut-off butterfly valve in the secondary circuit. The flow and return flow temperatures are measured in the supply line and in the customer circuit, and binary operating and fault messages are recorded. These messages are transmitted to the TROVIS 6600 Automation System.

The system is scalable with the central TROVIS 6610 CPU Module performing the smart plant management. The CPU module is a freely programmable control unit with 20 universal inputs to optionally record binary or analog signals. In addition, twelve binary outputs and eight continuous voltage outputs are available. The system can be extended using different I/O modules, i.e. it can be adapted individually to match customer requirements.



SAMSON

**SAMSON**

## REFERENCES



SAMSON AG · AKTIENGESELLSCHAFT  
Weismüllerstraße 3 · 60314 Frankfurt am Main  
Germany  
Phone: +49 69 4009-0 · Fax: +49 69 4009-1507  
E-mail: [samson@samson.de](mailto:samson@samson.de)  
Internet: [www.samson.de](http://www.samson.de)

SAMSON CONTROLS LTD  
Perrywood Business Park, Honeycrock Lane  
Redhill, Surrey RH1 5JQ  
Phone: +44 1737 766391 · Fax: +44 1737 765472  
E-mail: [sales@samsoncontrols.co.uk](mailto:sales@samsoncontrols.co.uk)  
Internet: [www.samsoncontrols.co.uk](http://www.samsoncontrols.co.uk)